

TARAS TKACHUK
YAROSLAV MELNYK

TRANSLATED BY
OLEKSANDR MELNYK



SEMIOTIC ANALYSIS OF
TRYPILLIA-CUCUTENI
SIGN SYSTEMS

**Galician Scientific, Cultural and Historical Society, National Reserve
"ANCIENT HALYCH"**

**Taras Tkachuk
Yaroslav Melnyk**

**SEMIOTIC ANALYSIS OF
TRYPILLIA-CUCUTENI
SIGN SYSTEMS**

Translated by
Oleksandr Melnyk

Ivano-Frankivsk
«Symphony forte»
2021

UDC 903.23(477)

Reviewers

Volodymyr Baran, PhD. *Professor, Corresponding Member of the National Academy of Sciences of Ukraine*

Mykhailo Khladkykh, PhD., *Professor*

Editor

Prof. Dr. Yaroslav Melnyk

Recommended for publication by the Academic Council of the Vasyl Stefanyk Precarpathian National University

Original publication

Ткачук Т. М., Мельник Я. Г., Семіотичний аналіз трипільсько-кукутенських знакових систем (мальований посуд) - Вінниця: НОВА КНИГА, 2005. -208 с. - ISBN 966-8609-50-6

Tkachuk T. M., Melnyk Y. G., Semiotic analysis of Trypillia-Cucuteni sign systems (painted dishes) - Vinnytsia: Nova Knyha, 2005. -208 p. - ISBN 966-8609-50-6

Translation to English, cover design, typesetting and technical editing

Oleksandr Melnyk, MSc.

The original publication was published in Ivano-Frankivsk (Ukraine) and later reprinted in Vinnytsia (Ukraine) by Nova Knyha Publishers in 2005. The work has been digitalised and subsequently translated to English in Vienna (Austria) in 2020.

Tkachuk T. M.

Semiotic analysis of Trypillia-Cucuteni sign systems / Taras Tkachuk, Yaroslav Melnyk; Translated to English by Oleksandr Melnyk. – Ivano-Frankivsk: Symphony forte, 2021. – 250 p.

ISBN 978-966-286-215-7

The book is devoted to the study of ornaments of one of the brightest cultures of the Eneolithic territories of Ukraine, Moldova, and Romania. The study proposes the study of ornamentalistics in synchrony and diachrony in terms of semiotics, which in turn allowed to obtain new data on the functioning of ornamentation of hand-drawn dishes of Trypillia-Cucuteni. The book is aimed at specialists in the field of semiotics, cultural studies, history, and the general reading public.

UDC 903.23(477)

ISBN 978-966-286-215-7

© Taras Tkachuk, 2000
© Yaroslav Melnyk, 2000
© Oleksandr Melnyk, 2021











The present scientific publication investigates the ornament of the Trypillia-Cucuteni cultural and historical community, which existed on the territories of modern Ukraine, Moldova, and Romania.

Recently, authors far from archaeology claim that the Trypillia-Cucuteni community has a well-developed script of the Sumerian type. Therefore, the Authors see the importance to show what the small elements of ornamentation appear in the context of general painting schemes, their connections and the means of their arrangements in blocks. All these indicators are summarized in catalogues and the tables. The catalogues indicate the number of uses of each character. Further, the sign systems of respective settlements are selected and analysed. This allows a detailed analysis of the sign systems of the Trypillia-Cucuteni monuments with the signs of the Sumerian pictographic writing and the linear signs of the Neolithic and Eneolithic stages of the Balkan peninsula.

For the first time, the book presents a significant amount of synchronous and diachronic analysis of painted utensils of all local groups of the Trypillia-Cucuteni cultural and historical community of the stages of BII-CII,γII/end of V millennium BC - the first half of III millennium BC/as "living" dynamic sign systems. An integral part of this analysis was the most complete (where the material allowed) compilation of tables-schemes of ornaments on utensils, complete graphics of small signs, created tables of ratios, schemes of painting and shapes of utensils. The book is addressed archaeologists, semiologists, culturologists, art critics and anyone interested in the phenomena of pre-written cultures.

Please note that this is the first edition of the translated manuscript which has not yet been fully proofread. If certain inconsistencies are found, please contact the authors for or refer to the original publication for clarification.

CONTENTS

Aknowledgments.....	6
Foreword.....	7
Abstract.....	8
Introduction	10
History of research of semantic value Trypillia-cucuteni ornamentation. Achievements and challenges.	12
Periodization and synchronization of Trypillia-Cucuteni settlements. stages BI - CII-γII	27
Sources. General characteristics	38
Research methodology	46
Syntactics and semantics of basic semantic markers.....	55
The sign “black (red) circle”, ● ○	56
Borders in the form of ribbons filled with horizontal parallel lines. 	62
Lenticular oval 	64
Wavy ribbon 	70
Cross symbol in a circle (medallion) 	78
Sickle-shaped sign 	82
Vertical rows of dashes 	90
A medallion filled with papers 	93
Straight vertical lines and stripes. 	95
Oblique lines or ribbons 	98
Quadrilaterals 	100
A vertical strip flanked by two vertical hemispheres 	103
Syntax and semantics of iconic characters.....	105
Zoomorphic signs.....	105
Ornithomorphic signs.....	113
Signs of plants.....	114
Anthropomorphic signs.....	119
Anthropomorphic ware	119

“Owl's face”	126
Anthropomorphic tableware without a “head”	130
Unique anthropomorphic schemes	133
Anthropomorphic images (signs).....	133
Image of the moon on the schemes of painting	135
Pragmatics of Trypillia-Cucuteni sign systems.....	141
Signs of the moon - black (red) circles and sickles	141
Signs of the full moon - medallions with hemispheres (1) and crosses inside (2).....	143
Signs of water - wavy line or ribbon: ribbon filled with parallel horizontal lines, groups of vertically arranged short dashes	144
The sign of the grain is a lenticular oval	145
Vertical strips flanked by vertical hemispheres.....	146
Dynamics of use of the basic figures of a list of wares.....	154
Search for subjects of semiosis.....	159
Sign systems of the Trypillia-Cucuteni community and writing	212
Development of the pictographic system of the Tomashivka group.....	221
Autochthony of pictography of the Trypillia-Cucuteni community.	222
Sign systems as an index of relations “society - higher powers”	223
Conclusions	235
List of References	238
List of Figures	244
List of Histograms.....	246
List of Tables	247
About Authors.....	249

AKNOWLEDGMENTS

The authors express heartfelt gratitude to colleagues **V.O. Kruts**, **M. Y. Videiko**, **N. B. Burdo**, **K. K. Chernysh**, **S. O. Gusev**, **I. I. Zayets**, **O. O. Yakubenko**, **S. M. Ryzhov**, **L. I. Polischuk**, **V.G. Zbenovych**, **O. G. Korvin-Piotrovsky**, **V.A. Kosakivsky**, **T. G. Movsha**, **V.O. Shumova**, **V. M. Bikbayev**, **V. O. Dergachev**, **V. G Petrenko** for the opportunity to get acquainted with the materials used in this work.

We would also like to thank our friends, with whom the ideas proposed in our book have been repeatedly discussed.

One of the authors is immensely grateful **to S. Zvarych (Kovalevskaya)**, **A. Yeromenko**, **A. Murashkin**, **I. Malakhov** for the opportunity to stay many years in Kyiv, which allowed to work at the Institute of Archaeology and collect the necessary material for work.

FOREWORD

Since the arrival of the first agro-pastoral societies in the Balkans, a significant number of Neolithic European ceramic sets are characterised by an ornamentation based on geometric motifs, such as triangles, chevrons, spirals and grids. The archaeological culture of Trypillia-Cucuteni is one of the most recent and differs from its predecessors in the abundance of painted ceramics, in the technical quality of the decorated vessels and in the diversity of the combination of motifs.

In this book, Taras Tkachuk and Yaroslav Melnyk propose to apply the techniques of semiotic analysis in order to identify what the signs used represent and to determine the rules governing their association. The framework of the study is centred on the BII and CII phases, because of their particular richness. The analysis is preceded by a welcome historiographical review of the work already carried out and the paradigms according to which researchers have so far attempted to interpret the decorations uncovered.

The study of the corpus begins with a periodisation of the sites that yielded the selected sets. In addition to signs whose animal, human and plant significance seems obvious, Taras Tkachuk and Yaroslav Melnyk identify 12 other more stylised signs. Each one is presented in detail in terms of its variations and associations with other signs. In order to make the discussion as comprehensible as possible, the authors have chosen to insert the graphic examples cited in the text, at the risk of making them too small to be easily readable. This analysis of each sign is followed by a study of the associations and their dynamics. In particular, it allows the authors to identify representations of the moon at different phases and to see with which other symbols our satellite was associated. This detailed analysis makes it possible to address the question of the interpretation of the ornaments as writing or proto-writing.

The authors were able to identify a number of graphic units composed of several signs, but show that these are not words, and therefore not writing, but rather indications that reinforce the meaning of the sign or contextualise it. The excellent mastery of the chronology of these productions finally allows the authors to place these observations in the diversity and evolution of Trypillia-Cucuteni societies. Even if the authors, in their conclusion, insist on the directions in which their work must be pursued, the contributions are solid and show the potential of semiotic analyses of Neolithic ceramic decorative corpuses. It would certainly be useful to extend the analysis to the pre-BII corpus and, above all, to carry out similar analyses of the other ceramic corpus belonging to the same decorative tradition.

Karim Gernigon, PhD.

Conservateur régional de l'Archéologie

Service régional de l'Archéologie

**PRÉFET
DE LA RÉGION
AUVERGNE-
RHÔNE-ALPES**
*Liberté
Égalité
Fraternité*

Direction régionale des affaires culturelles
Auvergne Rhône-Alpes

ABSTRACT

This article deals with surviving Trypillia-Cucuteni ceramic vessels which are regarded as one of the most vibrant cultural phenomena of the given civilization.

These vessels drew the attention of researchers since they were discovered. Their specific ornament and shapes allow the identification of the Trypillia-Cucuteni ceramic civilization as a distinct cultural community. They also enable one to specify the territory of this community and establish the phases of its development. A great part of the above-mentioned archaeological issues is addressed by way of studying the general outlines of vessel patterns and vessel shapes. Besides, the researchers display interest in the meaning rendered by individual sketches and their elements. It should be noted that the elements of ornament and principles of their arrangement as well as rules of their creation and alteration have not been described by scholarly papers. Without such research efforts, many questions concerning the outlook of the representatives of the Trypillia-Cucuteni ceramic civilization and its history become totally or essentially irrelevant.

It is precisely this source that may facilitate the investigation of such a significant historic and cultural phenomenon as the appearance of the written language. It will allow one to draw a comparison of the Trypillia-Cucuteni semiotic systems to Summerian pictographic characters and linear signs used in the Balkans in the neolithic period. Therefore, the study of the most ancient sign systems used in South-East Europe in the Eneolithic age as well as the study of the regularities of their development in the historical context are regarded as one of the major research tasks. Analyzing the ornamental patterns, this paper employs the traditional comparative and typological research methods as well as a statistic, positional, and structural semiotic methods. Ornament is viewed as the secondary semiotic system consisting of a certain number of graphic and plastic signs.

The article is chronologically limited to stages BII-CII-γII. It is explained by the fact that this period of Trypillia-Cucuteni history was marked by massive semiotic activity and that the excavations carried out on the site of Trypillia-Cucuteni settlements produced a lot of material evidence allowing well-documented conclusions. Geographically the paper focuses on such regions as the right and left banks of the Prut river (Romanian Moldova and the Republic of Moldova), areas adjacent to the upper-middle and lower sections of the Dniester river as well as the Middle section of the Bug river, territories adjacent to the South-Eastern coast of the Black Sea, and the area situated between the South-Buh river and Dnieper river.

The research is based on the study of 7,917 ceramic vessels and fragments housed in the museums in Kyiv, Odesa, Cherkasy, Talne, Ivano-Frankivsk, Vinnytsia, and Kishinev. The author also uses the published works illustrating the artifacts from settlements located in Western Ukraine, Moldova, and Romania. Thus, the paper is innovative in making an extensive synchronic and diachronic analysis of painted vessels, which date from BII-CII y n and are attributed to local groups of the Trypillia-Cucuteni civilization. They are treated as "living" dynamic systems. The essential part of the analysis is devoted to the identification of basic archaic signs which evolved into subsequent systems as well as the investigation of the frequency of their employment and their cultural context. The results of the research indicate that treatment of the ornament of Trypillia-Cucuteni vessels as a secondary semiotic system allows one to view this phenomenon as a dynamic formation where each sign establishes paradigmatic and syntagmatic relationships with other signs. It also allows a diachronic and synchronic study of these signs.

The segmentation of Trypillia-Cucuteni ornamental patterns made it possible to identify mobile and fixed elements. The analysis of the small-size elements (signs) gives insight into their arrangement within the composite fixed elements and provides paradigmatic sets of signs. The diachronic study produced a minimum set of signs (semantic markers) within which other signs (block) were formed. They were in use from the start of BII to the end of CII-γI. Some of them were employed till the end of CII-γII. The obtaining of semantic markers of the semiotic systems and the investigation of the semantic fields formed by them as well as the frequency of their synchronic and diachronic usage gave a better idea of the values espoused by this cultural community. Synchronic inquiry into the usage of signs discovered in several settlements allows the assumption that each family developed and employed a system of distinctive signs.

The authors argue that the disappearance or drastic fall in the use of several signs at stage CII-γII alongside a sharp increase in the employment of the remaining graphemes as well as the reintroduction of signs, vessel shapes, and ornamental patterns specific to stage BI-γ BII are indicative of significant changes in the ideology of the period. Besides, the investigation of these phenomena makes it possible to advance a hypothesis about the concurrence of linear and cyclic processes in the evolution of semiotic systems. The inquiry into the frequency of the employment of signs and the increase in their use at the end CII-γII brought about by the crisis in Trypillia-Cucuteni societies indicates that ornamented patterns served as magic pictography.

INTRODUCTION

The production and ornamentation of dishes is the most massive and vivid manifestation of the activity of the population of the Trypillian-Cucuteni community, which has reached our time. It is because of the originality of the ornamentation and forms of ceramics on which it was applied, this cultural and historical community is identified, the territory which it occupied is outlined, the stages of development are found out, local variations are explored, the phases of their existence are studied. The issues concerning its chronology, synchronization of various local groups, links between them, as well as microchronology of individual settlements are studied.

All this wide range of archaeological problems is solved at the level of studying the general schemes of ornament in their unity with the forms of utensils. Also, researchers are interested in the semantic significance of individual schemes and their parts. There is quite a lot of literature on this. But it interprets certain elements that, as a rule, find analogies in the environment (signs-icons by Charles Peirce) -for example, images of plants, anthropomorphic figures, the moon, snakes, dogs, bulls, and more. The main method used in them is a kind of retrospection from the known mythology and ethnography, usually of Indo-European peoples (Greeks, Indians, Slavs, Lithuanians) to the actual Trypillia-Cucuteni ornaments. In this case, erudition in the field of mythology and ethnography is important, which is taken to help in the analysis of often very limited archaeological material.

Before looking for analogies in late mythologies and ethnography, it is necessary to have the most complete internal study of the actual ornamentation. And this, unfortunately, does not exist. The study of the whole complex of elements of Trypillia-Cucuteni ornaments, the principles of their organization and combinations, the rules of formation and replacement has not yet been carried out. Without such a study, many issues of worldview, history, culturology of Trypillia-Cucuteni societies lose their source base, or it is very limited.

Studies of small elements of ornament (signs), their contexts in full have not been conducted yet. But this source can serve, for example, to study such an important topic of general culturology as the history of the origin of writing. This question has become especially relevant recently in connection with the statement of some researchers, picked up by the media, that the population of the Trypillia-Cucuteni community has a developed Sumerian script, they say, the name of Trypillia - "Aratta" and can be read on clay tablets (Kifishin A. G., 1990. pp. 31-33). Therefore, it is important to show what the small elements of ornamentation look like, their connections with each other, the principles of their installation in blocks. This will finally make it possible in the future to make a detailed comparison and juxtaposition of the sign systems of the Trypillia-Cucuteni settlements with the signs of the Sumerian pictographic writing and the linear signs of the Neo-Neolithic of the Balkan Peninsula.

The aim of the study is to clarify the most general patterns of development of one of the oldest sign systems of the Eneolithic era of South-Eastern Europe, Trypillia-Cucuteni, in connection with historical events in this region of agricultural ecumenism. To achieve this, it is necessary to conduct diachronic and synchronous observations on the dynamics of the use of signs, both common to all settlements and for each settlement within local groups, as well as schemes of painting utensils, red paint on them, anthropomorphic, zoomorphic, plant, and other signs that are not part of commonly used graphemes. All these studies are conducted with an emphasis on sign systems that occur during migration, are in the area of contact between different groups or on the periphery of the cultural community, or conversely, exist during the stable development of the community.

Excavations of Trypillia-Cucuteni settlements in recent decades have yielded a rich material consisting of large series of pottery. This allows not only to study it by traditional archaeological methods but also to apply to its study statistical-positional and semiotic methods using the principle of additionality. Niels Bohr, who proposed this principle in the field of quantum physics, considered it important for human language and knowledge in general. According to the principle of additionality (in the general cultural sense), the description of complex objects and phenomena can be obtained only by comparing seemingly contradictory images and concepts (Ivanov V. V., 1984. p. 8). Therefore, the statistical-positional and structural-semiotic methods of studying ornament were used in the work not to contradict the best achievements of the retrospective method, which is created in the fields of research of the variable value of ornament.

Ornament in the work is considered as a secondary sign semiotic modeling system (according to BA Uspensky) (Lotman M. Y., 1992., p. 142). The system consists of a set of signs, where the term "sign" is understood very broadly. To paraphrase Husserl, we can determine that each graphic (and plastic) expression is a sign (Reformatskij A. A., 1987., p. 27). For semiotic analysis, the ornamentation of utensils in the period from stage BII to CII-BII was chosen because it is at this time that the greatest manifestation of the significant activity of the population of the Trypillia-Cucuteni community is observed; excavations of settlements of this time gave a lot of ceramic material, which allows to obtain well-documented conclusions.

The book provides a synchronous and diachronic analysis of a significant number of painted utensils of all local groups of the Trypillia-Cucuteni cultural and historical community (in total - 7,917 units of utensils or its significant fragments) as living, dynamic sign systems. The basic archaic signs from which the later sign systems have developed, trace dynamics of their use, and also their semantic fields are allocated. The analysis of the use of signs in each of the dwellings of well-researched settlements made it possible to single out social units that created new sign combinations. Based on statistical indicators the increase in the use of signs before the crisis state of Trypillia-Cucuteni societies (at the end of the CI-yl stage) is documented. Observations on the shapes of utensils, the use of red paint in paintings, and certain schemes and signs allowed to propose a hypothesis about the cyclical nature of the development of Trypillia-Cucuteni sign systems.

Beginning with this section, it is necessary to point out the importance of works devoted to the formal analysis of the development of tableware ornamentation. In essence, these works are structural. All other studies, including this work, are based on their chronological, typological, and classificational conclusions. Since semiotic research, in addition to formal syntactics, includes semantics and pragmatics, the question of meaning is a significant one. Therefore, the following chapter reviews the achievements in this area of knowledge about the Trypillia-Cucuteni ornaments.

HISTORY OF RESEARCH OF SEMANTIC VALUE TRYPILLIA-CUCUTENI ORNAMENTATION. ACHIEVEMENTS AND CHALLENGES.

According to the French semiotician R. Barthes, the history of the sign is the history of its "awareness" (Barthes, 1989., p. 247). He identified three types of awareness of the sign: symbolic, paradigmatic, and syntagmatic.

The first awareness – symbolic, prevailed and continues to dominate in the literature on ornamentation. It offers the depth, experiences of the world as a relation of the form lying on the surface and some multifaceted, powerful abyss. "Symbolic awareness," writes R. Barthes, "sees the sign in its deep, so to speak, geological dimension. Because it is the tier of what "means" and what "is" signified that creates the symbol (ibid., p. 247-248). For example, there is an idea of the vertical relationship of the image of the cross and the sun (in pre-written cultures) with all related beliefs, values, and ideas contained in mythology and ethnography.

"The vertical connection," Barthes continues, "gives the impression that the symbol is lonely, the symbol rises high in the world, and even if we consider that it is characterized by infinity, it more and more resembles a forest with its chaotic underground connection of intertwined roots (of what it means)" (ibid. p. 248). Thus, symbolic awareness retains its force as long as the analytical view passes by the formal relationship between the signs (without noticing or ignoring them), symbolic awareness is a rejection of form, he is interested in what is meant; what it means is always derived from it" (ibid., pp. 248-249).

The very fact of the presence of Eneolithic ornamentation attracts attention and raises questions, caused by the fact that the German philosopher Gadamer called "a call-to-answer" (Gadamer H.-G. - 1988 -S. 439, 443). The general questions with which this rich ornamentation "addresses" the researcher concern his consciousness (and subconscious) at all levels: who were these people who left such a bright phenomenon? What was the level of their development? What were their ideas about the world? What were their beliefs? Who followed them? What is left of their heirs? These are just some of the issues of ornamentation to symbolic awareness.

The first work, which went beyond purely archaeological issues (chronology, typology, etc.), was devoted to signs on ceramics from the excavations of Khvoyko. Researchers Linnichenko and Khvoyko distinguish 17 different signs that differ from the ornament "due to their shape and position" (Linnichenko I. A., Khvoyko V. V., 1901. p. 119). These signs, as it became clear later on, are very stylized images of animals and the moon (the last sign of the series). They were probably applied to the cups. The authors rightly point out that the number of signs with the continuation of excavations will increase significantly. According to researchers, they are very similar to hieroglyphs, although they are not directly associated with writing.

In addition to the signs, this work contains a mysterious "inscription", which is applied to a small vessel. It consists of a small number of different graphemes and is linear. This is a unique find, nothing similar has been found among the painted utensils of the Trypillia-Cucuteni community during the whole research period. At least there are no reports of this. One could even consider this "inscription" a forgery, but recently there was a discovery in the settlement of Bernashivka, which is a fragment of a cup with two marks on it. One (left) has a skeleton-like appearance, and the second (located on the right) consists of a pattern of an empty oval, depicted at the top, from which the line is drawn down. These signs

resemble the "inscription" given by Linnichenko and Khvoyko. And although the question of the authenticity of the "inscription" remains open, one real argument has emerged in its favor.

As we can see, the question of the existence of mysterious written or pre-written signs arose almost from the very beginning of the study of culture. It is part of a larger problem, namely the level of development of Trypillia-Cucuteni society. After all, the presence of writing or the beginning of its origin gives grounds to put this society on the same level of development as the civilizations of Mesopotamia, the Balkans, Crete, Asia Minor. Conversely, in the absence of writing (or its origin) as one of three archaeological features of civilization, it can be argued that the population of that time did not follow the path of creating something like the Sumerian cities - states, or Egyptian nomes. Although, as Linnychenko and Khvoyko had hoped, the number of signs has increased significantly since the first excavations of the Trypillia-Cucuteni settlements, the number of linear inscriptions has hardly increased. Despite the rather large-scale excavations, they are extremely rare, so they are all unique. This fact alone indicates that the population of Trypillia-Cucuteni settlements did not have a script like the Sumerian or any other, which would record primarily economic affairs. A complex system of signs served a different purpose than the economy of accounts.

The study of the other possible functions of the Trypillia-Cucuteni ornaments began at the beginning of the XX century. In 1902 the work of Bobrinsky was published, devoted to the study of "symbolic signs in the general primitive ornamentation of all the peoples of Europe and Asia" (Bobrinsky O. O., 1902). Although it does not directly touch the Trypillia-Cucuteni culture but is important for the study of its ornamentation. Ivanov points out that, anticipating the methods of modern semiotics, Bobrinsky proposed to study ornaments according to the methods of linguistics, studying each sign, looking for its etymology (Ivanov V. V., 1985., pp. 341-342). He concluded that the ornamentation of primitive tribes and peoples has some similar drawings for all peoples, which form the basis of world ornamentation (Bobrinsky, O. O., 1902. p. 3). The researcher believed that the forms existing in ornamentation represent only the development of some very typical categorical forms, which generally constitute a certain cycle of figures, each of which has its meaning (ibid., p. 4).

This idea has recently gained support in the study of the ancient Egyptian mythology of the birth of the Sun by the goddess of the sky Nut, which expresses the idea of the origin of an array of lunar and solar signs: Neolithic (and Eneolithic) from female and male Paleolithic signs (Toporov, V. N., p. 87). Bobrinsky considers two specific types of signs - in the form of snakes and birds. The snake, which, in his opinion, was the enemy of man, was transmitted graphically by a wavy line or spiral, the bird - a swastika or across (a bird in the sky). To determine the meaning of these images Bobrinsky turns to mythology, especially Indian, where he finds a bird Garuda - a deity that kills snakes and reptiles. His symbol was a swastika.

Thus, along with important methodological ideas in the work of Bobrinsky, attempts were made to identify the meaning of some signs - the cross, swastika, wavy line, and spiral. The very definition of the spiral as a symbol of the snake laid the foundation for another study in the field of Trypillia ornament, namely the article on the heraldry specialist Bolsunovsky "Symbol of the snake in the Trypillia culture", published in 1905. This seems to be the first work devoted directly to the analysis of Trypillia ornaments, namely deepened and painted wavy and spiral ornaments, which, according to the researcher, depict snakes and are evidence of snake worship in the Eneolithic population. The snakes depicted in urns, as researchers then believed, were to help the souls of the dead find a way to a new life.

Special attention should be paid to the research methodology. Here, as in the work of Bobrinsky, the explanation of the image of the serpent involved a wide range of sources - from Herodotus, from his

mentions of the Neuri and Budini, whom Bolsunovsky considered the bearers of Trypillia culture. Ending with the mythologies of Slavs and Lithuanians the ancestor of which were, in his opinion, the Neuri and Budini. Another work dedicated to the signs on the dishes of Trypillia culture was published in 1908 by Bolsunovsky. The aim of this study, according to the author, is to compare these signs with paleographic and symbolic monuments of the ancient world. Following Khvoyko, the researcher divided the signs into two groups: palaeographic and symbolic. The first group includes various images from the animal world in their combinations with each other, the second - astral and astrological signs (Bolsunovsky K. V. 1908. p. 4-5).

For the first time, the presence of signs is determined by the requirements of the ritual, which in the light of modern theories of the cultural life of archaic societies from the ritual - acquires special significance (Toporov V. N. 1988. p. 7-60; Evzlin M., 1993., p. 168-208). According to Bolsunovsky, signs are "prototypes of some ornamental alphabet, prototypes of writing" (Bolsunovsky, K. 1908. p. 4, 8). He believed that the ritual and religious signs were forgotten by the Slavs, Greeks, and Romans, but are well preserved in China in the form of an ornamental font, thus the Trypillia signs are compared to Chinese characters. It should be noted that here Bolsunovsky is ahead of some later comparisons of Trypillia-Cucuteni images with Chinese Neolithic ornaments. As an example, we compare the anthropomorphic image of the Petreny group with "similar" images of the Yangshao culture (Evsyukov V. V. - 1988. p. 38). Even earlier, another motif of the Trypillia-Cucuteni ornamentation provoked the search for Chinese analogies (Bogaevsky B. L. 1931. p. 1-30), but this will be discussed later.

Bolsunovsky considered very stylized images of animals to be palaeographic signs, which attracted the attention of Linnichenko and Khvoyko in connection with the question of signs. The researcher interpreted them as signs composed of images of birds, worms, and claws of a dragon, a picture of a bird (eagle), dragon, unicorn, a combination of moon and worm, turtle, crawling dragon, and more. However, it should be noted that Bolsunovsky first drew attention to the fact that Trypillia signs are often formed from several components, i.e. obtained by combining several signs into one. In contrast to the previous work, the spiral is interpreted here as an image of the long journey of the soul of the deceased, to whom the urn belonged (Bolsunovsky K. V., 1908. p. 10).

It is necessary to tell about the intellectual atmosphere in which the first steps of researches of Trypillia ornamentation took place. On the one hand, the influence on the search in the mythologies of different peoples for answers to the questions posed by Eneolithic ornamentation had success in comparative mythology and studies of the mythological school. On the other hand, the great interest of educated society at the time to the nature of the symbol (especially poetry, literature, painting). The idea of comparing ancient Trypillia-Cucuteni signs with others has not been implemented to this day. The same applies to the introduction of linguistic methods for the study of archaic signs (Trypillia-Cucuteni, at least). These ideas are far ahead of their time and are still waiting to be implemented.

Linguistics has a constant tendency to cover other cultural phenomena in addition to the language. As we have seen, the ideas of comparison and etymology of signs have already appeared in the works of the early twentieth century on Eneolithic ornamentation. The second, more powerful wave of linguistic ideas came to research in the fields of ancient history, literary criticism, history of mythology, archaeology, including developments on the semantic significance of Trypillia ornamentation, with the advent of Japhetic theory of linguistics by Marr. It covered, however, only Soviet science and has long been considered almost equivalent to Marxism. It is the synthesis of the stage theory of Marr and Marxism, determined the main paradigm of the works of 30-40 years of Soviet science in the humanities. Here is how Schmidt writes about it in the introductory article to the VI volume of the "Japhetic Collection":

"Dialectically taking into account the general connection of phenomena, the Japhetic theory has consistently gradually expanded its field of vision and covered several issues in the history of material culture" (Schmidt F. I., 1930., p. 6)

The famous orientalist Dyakonov considers the main general historical error of the Japhetic theory to be its simplified reconstruction of typological stages of human development on the principle of direct analogy: primitive society corresponded to primitive thinking, the idea of it was formed mainly by Levi-Bruhl (theorist to people), class society corresponded to socialist-dialectical logical thinking. Despite these errors, continues Dyakonov, Marr, his colleagues Frank-Kamenetsky and Freidenberg touched on some interesting patterns of ancient thinking. One of them was the construction of ancient man associations not as abstract generalizations, and by "semantic series" and "semantic bundles", i.e. series of figurative and mythological connections (Dyakonov I. M., 1988., p. 180). It is these and some other ideas that allowed us to consider the phenomena of neo-Neolithic ornamentation not as aesthetic exercises, but as meaningful symbols. This idea is especially fully implemented in the work of Krychevsky, which is discussed later. At that time, in the west, the Trypillia-Cucuteni ornament was involved in the study of the semantic meaning of drawings. It seems, however, that researchers were interested only in images of animals on utensils. The researcher's special attention is drawn to the image of an animal with an additional element near the head - the griffin, according to Child (Child V. Gordon, 1923). Wilke in his book "Religion of the Indo-Germans" interprets the drawings of animals from Bilche Zolote as magical-religious images that were to extinguish the deceased, whose remains are in the vessel (quoted by Bogasvsky B. L., 1935. p. 190).

In 1931, a study by Bogaevsky devoted to the sign in the form of a lenticular oval. According to the author, the work is an eloquent illustration of the economic determinism of the worldview phenomena (Bogaevsky B. L., 1931., p. 99). Much attention is paid to the principles of an image in the ornament of the part instead of the whole. The meaning of "parts pro toto" in the semantics of language was developed in the then prevailing Japhetodology (ibid. p. 42-4-3). Ornament in this work is perceived as a magical and abbreviated pictorial language, which in the early stages of its development has meaning (ibid. p. 43). Bogaevsky emphasizes the great importance of the shell in the daily lives of people of Trypillia culture. Snails, in his opinion, were one of the main types of food, and therefore shells attracted great attention of man during life and after death. People of that time could not help but try to depict such a familiar and important in their life and religious life object as an edible shell on a painted vessel (ibid. p. 67-68). Therefore, signs in the form of lenticular ovals, according to Bogaevsky, are a pictographic system that transmits the image of a shell. In addition to lenticular signs, he attributed 8-shaped duties with fillings, ovals with painted semi-ovals, toothed and dusty curbs, horizontal 8-shaped arcs, i.e. a fairly wide range of signs (ibid. p. 74). Although Bogaevsky interpretations are now only of historiographical interest, in this work the Trypillia ornament was first called a magical-pictographic system (ibid., P. 72), which in itself is a great step forward in its realization.

Another study by Bogaevsky is devoted to the study of tools and domestic animal culture of Trypillia. Along with other issues, it deals with depictions of animals on ceramics. The researcher asked the following questions: "Why did the spirals of animal tapes suddenly appear? Why did the weakening of the spiral require the transformation of its elements into animals, and especially dogs? Who was the customer of dishes with animals? What did the image of the beast tell anyone who looked at it? Why was this drawing made?" (Bogaevsky B. L., 1935., p. 191). Having studied the stylistic features of images of animals, Bogaevsky concluded that "the basis of the images is the observation of the rapid running of dogs." Quite in the spirit of stage theory, they are recognized as the most viable and dynamic, which is

allegedly inherent in the early tribal society, in comparison with the images of dogs of the early class society of Crete and Mycenae, where, according to Bogaevsky, such drawings are less vital.

Bogaevsky considered the image of animals on the dishes in their connection with its contents (grain), not with the remains of the deceased. According to the researcher, "Utensils were perceived in a kind of ideology of the archaic community as a living guardian of what was stored in it." Therefore, the image of a dog drove away evil, had to protect from harmful actions, and drive away anyone who approached the dishes with evil thoughts (ibid. p. 194). Thus, dogs on the dishes with their aggressive postures were interpreted by him as apotropaic animals that guarded the stocks in the dishes. The dog on the dishes became a kind of pictographic sign with somatic content in its working function (ibid. p. 204).

The researcher's attention was drawn to the drawings of the tails of some animals in the form of plants or branches. This, in my opinion, testifies to the existence of the idea of the unity of animal and plant life in the imagination of the population of that time (ibid., P. 224). Images of dogs are divided by Bogaevsky into two groups: larger one, which consists of dogs of the "tape" type, the second is formed by more realistic drawings (ibid. p. 201). In his opinion, the main significance was given to the fantastic "tape" animals, which arose earlier than the realistic ones (ibid. p. 202). Yes, the author connects the image of the spiral with the developed matriarchy, hoe-farming, and the insignificant development of cattle breeding. The appearance of the image of a dog signals changes in the bowels of the maternal genus, which later led to an increase in the importance of livestock (ibid. p. 203).

In addition to drawings of dogs, Bogaevsky considers the image of bulls and horses, which, he believes, were evidence of the weakening of matriarchy and the preparation of the patriarchy of the post-Trypillia stage (ibid. p. 229-233). This, however, is an obsolete sociological theory. Sociological developments of this kind create the temptation to easily explain the complex phenomena of ornamentation, replacing the study of the innermost "life" of the sign system. Therefore, if we abandon the rough sociological interpretations, all the questions posed by Bogaevsky remain without unambiguous answers. In 1941, an article was published by Holmsten, the purpose of which was to draw the attention of "tribal society" researchers to the fact that the ornament of pottery is not an ornament per se, but a combination of signs that have a certain meaning.

The ornamentation reflects the worldview, which, according to the researcher, has largely preserved the magical principles (Holmsten V. V., 1941. p. 7). Images of animals are interpreted in the spirit of synthesis of totemistic and stage theories as a cult (ibid. p. 7). Similarly, the similarity of signs observed in large spaces is explained with the help of the idea of stagnation. According to Holmsten, it is in direct connection with the community of ideologies and thinking (ibid. p. 8). The work of Krychevsky, like Holmsten, although not directly, is also related to the study. In its significance, the ornamentation of the linear-ribbon ceramics culture contains several conclusions, which were later (especially in Rybakov's B. O. research) applied to the study of cosmogonic and cosmological representations of the Trypillia-Cucuteni community. Krychevsky considers the magical and religious significance of ornamentation in general and in connection to the worldview, which gave rise to the actual ornamental style. In addition to the theory of semantic bundles and the interpretations of the neo-Neolithic ornaments, Krychevsky was widely involved in the ethnography of the peoples of Southeast Asia, Oceania, and North America. He saw the basis of the worldview of farmers in the eternal changes of winter and summer, death and birth (resurrection), grain and fruit. The researcher identifies the main ornamental motifs underlying ornamental compositions, -spiral, meander, zigzag, which are the basis of all the rotating styles. These motives, in his opinion, are associated with the constant rhythmic repetition of ups and downs, they embody a continuous movement. Based on this, the researcher draws a general conclusion:

"The semantics of rotating style motifs are rooted in the cosmic worldview of the agricultural tribes of the European Neolithic (and Eneolithic, we would add)" (ibid., p. 78).

This conclusion is of great importance for the understanding of Neo-Neolithic symbolism. Krychevsky also has an important idea for further research that the mysterious signs that occur in the system of cosmic rotating style, also have cosmic significance by depicting certain elements of the sky, such as lightning, rainbow (ibid. p. 74). The wavy line in Krychevsky interpretation symbolizes water-sky-top and the earth (ibid., P. 77). It is associated with the image of snakes. Based on ethnographic materials, the researcher connects them with several smaller ideas, primarily with the cult of the sun and sky. Trying to understand the origins of ornamentation. Krychevsky also drew attention to the anthropomorphic vessels of the Neo-Neolithic. He believed that wavy lines, zigzags, concentric circles originated from images of the human face, eyes, women's breasts which further testifies to the tectonic ornamentation of the oldest utensils in Europe and the Danube-Dnieper region. Therefore, the researcher raises the question of whether the coating of pottery is a motive common for tattooing and painting of the human body (especially women), even the image of certain parts of it - eyes, face, chest. A person with such a tattoo was purportedly perceived as a man-sky, a man-sun. Earthenware, ornamented with spirals, zigzags, waves, in the original image was perceived as a tattooed man (ibid. p. 86). Such a detailed presentation of Krychevsky's ideas on neo-Neolithic ornamentation is caused by the fact that he made many interesting observations, which have not lost their relevance today. Important is his view of the multiplicity of each "cosmic" symbol, its connection with the "cosmic" pattern of ornamentation, as well as attention to such an important cultural code as anthropomorphism. All these observations are important for the further study of the ornamentation of all pre-written cultures, not just the Neolithic or Eneolithic.

In a monograph on the results of excavations of the settlement of Luka-Vrublivetska, published in 1953, Bibikov explored such manifestations of ritual actions of ancient farmers as the burial of children, jewelry and amulets, cult models of housing, and sculptural images. Applying comparative-historical analysis and broad ethnographic parallels, Bibikov concluded that in agricultural societies very early formed certain forms of beliefs, namely: the concept of cyclical nature, birth, and death, the relationship phenomena. At the center of religious beliefs and rites associated with fertility was the image of a woman (Bibikov S. N., 1953. p. 275). These important provisions were included in all subsequent works on the worldview of the Trypillia-Cucuteni population.

Symbolic awareness of Trypillia-Cucuteni ornamentation has reached its apogee since the 1960s. In the works of that time, there are no appeals to linguistic methods, instead, in their attempts to reveal the meaning of drawings on utensils, statuettes, etc., researchers have used mythology, religious studies, ethnography. Interpretations of the symbolism of the ornament were based only on the search for analogies in the mythological and ethnographic texts of different peoples. In most cases, the schemes and signs were compared with the texts of Indo-European peoples, where "similar" plots were sought. Most often they were Indo-Iranian, ancient Greek, or Slavic "parallel". Later, in the '80s, another stage of research began. The search for mythological analogies, however, remained, but there were formalizations and systematizations of the studied signs. Systematizations were often built on the principle of diachrony, which was a big step forward compared to the past when signs were simply freely involved in observations, often there was a gap between time and space. But the method of retrospective analysis from "known" ethnographic and mythological sources exhausted itself. Evidence of this was the skepticism of many researchers about the possibility of at least some correct interpretations, which

appeared fantastic, completely devoid of any methodological basis of writing from the worldview of writing society.

The question of semantic transitions from images to verbal texts is in itself very complex and requires research that goes far beyond archaeology. When does a graphic sign relate to a real-world object? What is the relationship between the signs and objects of the environment, the phenomena of the psyche (archetypes of the collective unconscious, according to Jung C. G.), or the sacred world (archetypes, in the sense of Eliade M.)? Thus, the study of such issues requires the search for new methods or synthesis of methodologies of different sciences. These methodologies are successfully being developed in semiotics, hermeneutics, linguistics. In this context, the work of Makarevich, devoted to the ideological ideas of the Trypillia tribes, the connection of cultural ideas is a person - a female figure of the mother - great - grandmother (Makarevych M. L., 1960., S. 201). This cult, in his opinion, was reflected in the ornamented motifs, which "undoubtedly had semantic significance." He also draws attention to the cult of the bull, whose images occur in ornamental compositions, and to the frequent images of snakes. According to the researcher, compositional schemes with the motif of snakes sometimes turn into a spiral and are the main ornament of early Trypillia society. Makarevich concluded that the drawing of decorated snakes and sculptures covering a woman's body is a motif of a tattoo. Perhaps this is how the image of the "snake woman" arises (*ibid.*, P. 257).

The image of snakes on dishes in certain compositions not only emphasized the cult meanings of snake motifs but also determined the symbolic cult purpose of dishes. According to Makarevych, such vessels were used to decorate sacred places in the dwellings of the settlements of Sabatynovka II and Grenivka (*ibid.*, P. 301). The article by Movsha is devoted to the image of a bull on a vessel from the early Trypillia settlement of Ozarintsi. The researcher notes that at the time of writing, zoomorphic images, in addition to snakes, belonged to the late Trypillia. In her opinion, the cults of the bull and the serpent, along with the cult of the Great Mother, were the oldest in the religion of the Trypillia-Cucuteni society (Movsha T. G., 1961. p. 82).

The article by Tsvek is devoted to anthropomorphic images on utensils and the ritual dance associated with the cult of fertility from the settlement of Grebeni (Tsvek O. V., 1964. p. 80). The images include the land on which there are sheaves, and around them, women perform a ritual dance. The scene itself, according to the researcher, is associated with the end of the summer season, the time of ripening of the crop; in this culminating period, there is an intensification of religious and magical rituals (*ibid.*, p. 81).

Based on previous developments, Rybakov (1964, 1965, 1981) proposed his reconstruction of the Trypillia-Cucuteni worldview as a single system. In his works, the retrospective method (combined with symbolic awareness of the sign) reached its apogee, as their results have long determined the understanding of Trypillia-Cucuteni ornamentation. Almost all further research in this area were conducted under the influence of his methodology. Rybakov conducted his research on the religion of the Eastern Slavs, which, according to the researcher, had deep roots, dating back to the time of the Trypillia-Cucuteni tribes. The researcher shares the view that these tribes were Indo-European. From these very hypothetical positions, he derives the "keys to guessing" the semantic meaning of the ornament. In his opinion, this is material from folk art which contains many elements that were first used in the Trypillia era (Rybakov B. A., 1965., №1., p. 25). This statement is quite premature because only sign systems can be compared and compared, not individual signs. But work in this direction has not yet been carried out in archaeology or ethnography. Therefore, the ethnographic key to determining the content of pre-written ornaments should be considered questionable.

Rybakov considers the Indo-European mythology of the Rigveda and the Avesta to be the second “key” to understanding ornamentation. But, as experts who study these texts point out, that each of them acquired its history and the form quite late. The oldest texts of the Rigveda date back to the XV century B.C. (Elizarenkova T. Y., 1989. p. 435), and Avesti - BI century BC (Braginsky IS - 1984. p. 53). This poses a question: when and where were the first hymns and prayers composed? So far, the researchers of Rigveda and Avesta are arguing over these issues. But none of them connects the origin of these texts with the time of the Neo-Eneolithic. Therefore, it is very problematic to connect the hypothetical archaic layers of the texts with the hypothetical territory of the Indo-Europeans, and the latter with the population - the bearers of the archeological Trypillia-Cucuteni community. All this allows us to consider the two proposed approaches, along with the third, too risky. These, according to Rybakov, would be the reconstruction of Indo-European vocabulary, which outlined the range of concepts by which ancient people defined the world and its understanding.

As the main methodological position to the perception of Eneolithic ornamentation Rybakov proposes the natural and economic determinism of the phenomena of ideology and worldview, namely - the dependence of farmers on nature, which is accompanied by fear and uncertainty, generating orders and rituals to reduce this fear. According to the researcher, this fear was especially intensified after sowing and while waiting for the harvest (Ribakov B. A., 1965., p. 21). According to Rybakov, the center of farmers' worldview is the sky with its reserves of celestial moisture, the change of seasons, the cycle of time and life (ibid., P. 26). In contrast to Krychevsky, Rybakov begins the analysis of ornamentation not with systems, but with individual signs, arguing that they, without changing since the Eneolithic, reached the XX century. The researcher identifies a total of 34 characters, dividing them into three groups. To the first, he attributed “clear signs”, i.e. signs that have analogies in the environment: images of plants, the moon, and a circle with a cross or three intersecting lines inside. They, in his opinion, symbolize the sun. The authors of this work disagree with this interpretation but set out our point of view later in the section on the syntactic of signs.

In what follows, we will present only the interpretations of Rybakov, noting those with which, in our opinion, we can agree. The second group includes signs that can be understood by their relationship with others. According to Rybakov (ibid., №1., pp. 30-31), a diamond filled with painted or empty hemispheres (ibid., pp. 30-31) and a rhombus divided into four parts with dots in the middle of each cell - a field sign with the grain (ibid., №1 p. 31). To the third group, the researcher carried signs, the content of which can only be guessed. These are signs in the form of lenticular ovals as well as ovals crossed with a vertical ribbon, which, according to the researcher, are symbols of the fertility of the matriarchy - the signs of a woman. Here he refers to the signs in the form of sheep's horns and udders (ibid., №1. p. 31).

The four-time organization of the ornament, according to Rybakov, was due, on the one hand, to the idea of the four directions of the world, and on the other - to the plowing of the quadrangular field. According to the researcher, four-time compositions appeared in the Eneolithic (ibid., №1. p. 31; Stolyar A. D., 1985., p. 125., Fig. 91-93). Therefore, if we accept the idea of Rybakov on the immutability of symbolic meanings, the signs that symbolize the direction of the world, were already used in the must. But, in contrast, it should be said that the same signs, especially those with simple graphics, often mean something completely different in the diachronic and even synchronous dimension.

Rybakov asks an important question:

“Who was spoken to by magical means, who depended on whether it would rain?” (Rybakov B. O., 1965. №1., p. 33).

In his opinion, the vessel with four embossed protrusions depicting women's breasts, represents the goddess of heaven and water, the archaic Ancestor, the basis of being, and the mother of all later gods. According to the researcher, it did not have a certain type at first but appeared only at the BI stage. Therefore, it was depicted only with one or another number of breasts, its main feature. Schemes of painting in the form of spirals, S-shaped arches, Rybakov interprets as a "Tangentenkreisband" image, not of snakes. He came to this conclusion by applying a positional analysis of these images on utensils and figurines. This helped him to establish a connection between the serpent (snake), the woman (the serpent on the ledges - "chest"), and the sky (water) (ibid., № 1. p. 37).

Rybakov expressed an interesting idea about the reflection in ornamental schemes of the picture of the world. The researcher pays attention to the three layers of paintings, in which he sees images of the three layers of the world. The first one below depicts the earth with plants, grain, and ears. The upper layer is the celestial firmament with ideograms of water in the form of a strip of drops, oblique lines, wavy horizontal stripes. The airspace is symbolized by the widest strip in the middle. Here, says Rybakov, two groups of signs were drawn: sloping rain lines and spiral ribbons with symbols of the sun. Thus, in this strip, rain and sun are depicted - two celestial phenomena that most interested farmers. The researcher interprets the schemes of the "Tangentenkreisband" painting as a continuous movement, the idea of time. The sun, moon, and serpents (S-shaped arcs) took part in such a movement (ibid., P. 43).

The researcher calls the paintings of the BI-CI stages "mythologized" (ibid. № 2. p. 13). He, quite precisely, notes the emergence of several new images that coexisted with the old ones. Old, archaic images, according to Rybakov, include images of segments with dashes at the ends, which were drawn at the end of two wide strips, one behind the other, which, in turn, were filled with various signs. This ornamental pattern was applied to the inner sides of the cut-conical bowls. The researcher considers them ritual bowls for "magic" water and interprets the segments as images of two celestial deer, the mistress of the sky, giving rain (ibid. №2. p. 15). Another scheme of painting on the cut-conical bowls in the form of large and two smaller ovals, arranged on the principle of mirror symmetry, reminiscent of the number "8", which Rybakov interpreted as an image of a woman's breast. This also embodied the idea of two celestial rulers of heaven, but already in human in the form. He considers the ribbons passing through the ovals to be a drawing of the Milky Way, which connects the sky, or the mythical celestial river "heavenly earth" (ibid., № 2. p. 17). According to Rybakov, a bowl depicts a snake in a bowl from Koshylivtsi Oboz, and in the space divided by rain or snake ribbons into six uneven sections, there are 12 crescents and two bean-shaped figures (ibid. № 2 p. 17). The image on the bowls of late monuments (Usatove, Ofatințitsi, etc.) Rybakov interprets it as an image of a celestial vault with a cross of coordinates and rain, which waters the earth from all four sides (ibid., № 2. p. 17). Further, the scheme of "owl's face" painting is the emergence of anthropomorphism of several cosmic concepts, namely - the face of the goddesses of the universe, the sign of the sun (concentric circles), and the goddess (place in the composition).

As we can see, in the case when Rybakov resorted to positional analysis, he obtained interesting results, which he never developed further. Of these, especially important - the selection by positional analysis of the series of signs, very close in meaning, i.e. it remains to take only one step to statistically positional studies and studies of the syntagma and paradigm of signs obtained this way. But, unfortunately, this did not happen. The researcher remained true to his symbolic "awareness" of signs and the search in Indo-European mythologies for plots "similar" to the Trypillia-Cucuteni drawings. Thus, the image of animals in the scheme "owl face" raises the question:

"Is this, sometimes, not the source of the myth of the multi-headed Hecate and her dogs?"

Also, from the point of view of historical mythology, he perceives the emergence of anthropomorphic painted figures, which reflect the idea of the birth of some extraordinary creatures associated with the sky (as he thinks, evidenced by images of bird paws instead of hands), water (rain streams and snakes) and land (anthropomorphism, and drawings of seeds next to them) (ibid., № 2. p. 22). Then the image is interpreted using the hymns of the Rigveda. Anthropomorphic images in lenticular ovals are recognized as Varuna (god of the sky and water). Another anthropomorphic image, the only one of its kind so far, with four hands, is interpreted as the Vedic Purusha (ibid., № 2. p. 22).

In the anthropomorphic figure in the oval from Koshylivtsi and the figures on the dishes from Belteni Rybakov sees the image of the dance of rain (ibid., № 2. p. 24). The ornament of the vessel from Krutoborodynets II, where animals are depicted in the upper tier of the painting, is interpreted by Rybakov as a spring order of well-being in agriculture, cattle breeding, and hunting. What gave rise to such conclusions? Symbolic awareness, multiplied by economic determinism. Dog and deer, according to the researcher, symbolize successful hunting, goat and goat-symbol fertility, caterpillar - a sign of plowed land (a sign of spring). The plowed land itself is depicted in the form of triangles. The image of the signs of sex in the drawings of animals, too, according to the researcher, indicates the "spring" time (ibid., № 2. p. 25). Images of dogs, painted in the upper tier of the "heavenly earth" are then placed next to drawings of plants, which gives grounds to interpret such images as the protection of arable land and seeds from animals (ibid., № 2. p. 26). Therefore, guard dogs were included as part of one of the most important cults - the cult of the fertility of grain and land. As a mythological parallel, Rybakov cites the Iranian myth of Senmurva - a winged dog that is a mediator between the god of the sky and the earth. He shakes the seeds from a beautiful tree, from which new plants are constantly growing (ibid., № 2. p. 27-28). As a conclusion, Rybakov proposed a hypothetical distribution of plots and evolution of the worldview of Trypillia.

Despite several very hypothetical interpretations, the work of Rybakov is important in the history of awareness of the Trypillia-Cucuteni signs. It is a kind of result of all that could be achieved by applying to the study of pre-ornamental ornamentation methods of direct mythological associations with Indo-European texts and ethnography, historical mythology, and direct economic determinism of worldview. The advantages and disadvantages of symbolic awareness of signs are shown in it most fully of all the research done before, while the question of agnosticism may be subject to understanding and interpretation (ibid., № 2. p. 31).

After the works of Rybakov, signs that find analogies in the environment continued to attract the attention of researchers. Two birds in a heraldic pose in front of a vertical ribbon. Movsha T. G. interprets them as a sign of the sun and birds, perhaps storks in front of the tree of life. The whole ornamental scheme, in her opinion, should be understood as a symbol of the family hearth and fertility (Movsha T. G., 1965. p. 105). Besides, signs in the form of letters W and V Movsha also interprets as the image of birds in flight. The presence of such signs on cubic figures from Usatov and Ofatințitsy, according to the researcher, combines the symbols of a bird and a woman (ibid. p. 102). Thus, Movsha proposes, that the ornament closely intertwines several symbolic images of a bird and a woman (Usatove), birds in front of the tree of life (Sushkivka, Zhvanets) (ibid. p. 104).

Danylenko V. M., as well as Rybakov, approached the Trypillia-Cucuteni ornamentation from the standpoint of clearly expressed historical mythology and economic determinism of the phenomena of spiritual life. Danylenko considered the worldview of the Trypillia-Cucuteni tribes to be religious-cosmogonic and "undoubtedly Indo-European", which, in his opinion, is confirmed in Indo-Iranian and especially in ancient Greek mythology and symbolism. He identified three stages in the development of

ideological ideas. The first stage is the perception of the world through the complex of "hunting Artemis", the complex of the Great Mother and the deer. The second stage is the vision of the world through the "pastoral Artemis" complex, which is manifested in the images of the Great Mother of the pastoral period and her husband. The third stage - a view of the world through the Demeter and her children, a man, and on the other hand - through the forces of heaven, which embodied a man. Demeter, the power of the earth, according to Danylenko, was attributed to a turtle, a frog, a snake, and plants. The power of the sky was attributed to a snake, a winged dragon, birds, the moon, the sun (Danilnsko V. N., 1969). Danylenko interprets the linear-ribbon ornament as an image of a sun-water snake - a dragon, and the image of a woman - a reflection of the image opposite to the forces of the sky, the personification of fertile land. It is interpreted as the personification of the cosmic marriage of Heaven and Earth. After analyzing the images, the researcher concluded that the vessels with such drawings reflected the myth associated with the Great Mother Earth and her divine companion when terrestrial and cosmic phenomena are closely intertwined. It is aimed at the fertility of wild animals in close intertwining with the magical power of human influence.

The images on the vessel from Costeshti IV, according to the researcher, reproduce a more complex ritual associated with general fertility. Movsha drew attention to such a phenomenon as the change of the sign of an ornamental composition when the anthropomorphic figure is replaced by the image of vertically arranged rhombuses. The researcher interprets this sign as the Tree of Life, a symbol of Mother-Earth. The second female image in a horned mask is connected, according to Movsha, with a rite of birth of celestial moisture. All this allows us to conclude that dishes with complex compositions from Zhvanets and Costeshti IV were intended for cult purposes. It was made and painted for ancestral hunting holidays (vessel from Zhvanets) and holidays of dying and resurrecting nature in general (vessel from Costeshti IV), which took place in home sanctuaries, probably in the winter-spring period. Besides, Zbenovich considered the cult of fertility, which originated from the agricultural nature of the economy, to be the basis of the ideology of the Trypillians. The main elements of cult views, in his opinion, were images of women, in which they combined the mother-parent, which gives new life, and life-giving forces of nature.

Archaeological finds from the early Trypillia settlement Bernashivka, studied by Zbenovich, still once emphasized the close connection of two cult images - a woman and a bull. The bull, according to the researcher, in the beliefs of the early agricultural tribes symbolized man and the sun. Zbenovich noted the importance of the cult of snakes. Accepting the interpretations proposed by Rybakov for the image of a "benevolent" snake that is supposed to cause rain. Zbenovich, on the other hand, noted that this interpretation cannot always be accepted. Analyzing the image of snakes on Bernashivka ceramics, the researcher noticed that their large heads are endowed with a pair of sharp horns, the wings are fed, and the eyes have a large, staring appearance (Zbenovich V. G., 1980., p. 153). This gave him a reason to interpret such images as snakes that bite to death, preserving food supplies.

The researcher also believed that at the initial stage of development of early Trypillia in ideological ideas the image of a snake was not yet associated with the female image. Only later female statuettes appeared with an in-depth ornament - a snake that protects the abdomen of the future mother (ibid. p. 154). Zbenovich expressed an important opinion on the emergence of these ideas and images. In his view, they originated in the area of the oldest civilizations of Asia Minor, the Middle East, and adjacent territories, in Southeastern Europe, they were revised and developed (ibid. P. 154). He devoted a section of his monograph to the worldview of the late Trypillia tribes of Northern Moldova. As a basis for interpretations of the semantic meaning of the ornament, Markevich took the works of Rybakov. Thus,

Markevich accepted the point of view of this researcher on the three-layer division of the world by the Trypillians, noting that sometimes there are no images of one or two layers on ceramics, but it is always shown in the middle. This system of ornament dominates in the paintings of the dishes of the BI stage. Besides, Markevich agrees with Rybakov's interpretations of the images of the spiral as a symbol of "benevolent" snakes; spiral ornament as an idea of the cycle of time and the infinite motion of the sun; four-part division of the ornament as a symbol of the change of the four seasons, the four corners of the world. A circle with festoons, a circle with a simple and oblique cross, concentric circles, and a dot inside Markevich considers being the symbols of the sun (Markevich V. I., 1981., p. 154). However, Rybakov considered a circle with festoons to be a symbol of the moon (Rybakov B. A., 1965., №1. p. 30).

Markevich perceives the image of animals on utensils as dogs that played a certain magical role associated with the cult of the fertility of plants, domestic animals, and the order of success in hunting, which coincides with the interpretations of Rybakov and Bogaevsky. Paying attention to the drawing from Petreny group, wherein the place of a solar or lunar symbol in a circle there is a silhouette of an animal, Markevich expressed his opinion about the cosmic significance of such an image (ibid., p. 159). He considered other drawings from that settlement in the form of fantastic animals with a bull's head and claws to be an image of a syncretic image of a lunar deity (ibid. p. 160). Markevich pays special attention to the last oval sign. Accepting the interpretation of this sign by Rybakov as a female symbol, Markevich drew attention to the fact that the free field often depicts various signs, which he perceives as rhombuses of fertility and symbols of the tree of life in the form of rows of rhombi with hooks.

There are also often signs in the form of letters M and W, which, according to the researcher, mimic the highly stylized bucrania, are symbols of a bull, not a bird, as believed by Movsha (Markevich V. I., 1981., p. 156; Fig. 102. p. 163). In contrast to Rybakov, Markevich connects the symbol of the bull with the moon and its phases. Turning to mythology, the researcher noted that the lunar deity appeared there in the form of a snake, fish, ram, lion, dragon, but most often - a bull (ibid. p. 155-156). Several M- and W-shaped symbols inside the oval Markevich considers as a sign of fertilization, and a tree symbol - as pregnancy. The researcher thinks that this is how the connection of the tonic deity - the Great Mother (Mother Earth) with the male horned lunar (or solar) deity - the bull is depicted. That is, this is how the notion of the marriage of earth and heaven was depicted (ibid., P. 162). This interpretation coincides with the already stated opinion of Danylenko about the existence of such ideas in the Neolithic era, however, in Markevich it is more coherent. Markevich interprets multi-figure compositions from Costeshti IV and Brynzen III in the same way as other researchers. In his opinion, there are scenes of magical dances performed by women priestesses with a prayer for rain, for the reproduction of wild and domestic animals, for success in hunting. The dance, according to the researcher, was integral to the ritual. Along with the scenes of the rain call dance, he distinguishes between images of scenes about the health of a cow (ibid. p. 164).

Late Trypillia ornament, says Markevich, is characterized by a rich construction ornament, which covers the lid surface of the vessel from crown to bottom. Ornamental belts often covered the vessels in two, three, and four layers. He believes that this phenomenon was caused by the development of ideas about the polytheism of the world, especially the sky (ibid. p. 161). In his opinion, this can be interpreted as evidence of the existence of the zodiac and lunar calendar in the Trypillian culture (ibid. p. 165). The appearance of anthropomorphic static images at the end of the middle Trypillia indicates, according to Markevich, the presence at this time priests, mediators between man and the forces of nature. But the symbolic awareness of the Trypillia-Cucuteni signs in combination with the historical-mythological and economic-deterministic approach to the phenomenon of ornamentation has acquired a high status and

entered into generalizing works on Slavic mythology (Rybakov B. A., 1981., p. 146-2) and the Eneolithic of South-Eastern Europe (Chernysh E. K., 1982., pp. 241-252).

Instead, the lack of systematic analysis led to the fact that a huge amount of material was left out of the attention of researchers and was not involved in scientific circulation. This is partly due to the fact, that the symbolic awareness is not effective during the work with the vast majority of signs, that have no analogies in the environment, due to the missing connections such as: drawing a plant -Tree of Life circle with a cross-sun and so on. The successes in the field of semiotic studies of mythology and ethnology, which were conducted in Tartu and Moscow as well as the acquaintance of a wide range of scholars with works on linguistic semiotics, could not but affect archaeology. And in 1983 the first work appeared, where the term "sign" was perceived (though not consistently) as a semiotic category.

A small work by Novytsky and Polishchuk is devoted to a group of signs that were not included in ornamental schemes. The authors drew attention to the different definitions of the terms "sign" and "sign composition". Thus, they note, that Formozov considered the signs of the image, which are rare, unrelated to the ornament, and are schematic. In contrast, researchers come to a very important conclusion that each rhythmic element of the ornament can be a sign, painting on the vessel - is a rhythmic sign composition. Thus, almost every image could be a sign (Novitsky E. Y., Polishchuk L. Y., 1983, p. 136-137). Unfortunately, researchers did not use semiotic methods, and interpreted some signs, including economic determinism and symbolic awareness (ibid. p. 138). In their opinion, single signs are a reflection of ancient agricultural rituals, which occupied a prominent place in the calendar cycle of ancient farmers (ibid. p. 110).

Tsibeskov's work, published in 1984, is devoted to two important "codes" of Trypillia culture - monthly and numerical. It is based on material from a settlement near the Berezovskaya power plant on the Southern Bug river, namely: a vessel on an anthropomorphic stand, which he believes, according to Rybakov, is associated with the rite of summoning rain, "watering the earth" with a request for fertility; the bowl, which is divided into three bands, which (also according to Rybakov) is interpreted as a symbol of the earth, the upper sky with water reserves and airspace with stars, sun, and moon. A table on legs, which externally depicts a sign in the shape of a Christmas tree - "tree of life", outer space, in which clouds and celestial bodies float in the center, in several turns depicts a snake, which, according to the researcher, was associated with the moon - a source of water. Inside is also a spiral filled with recesses. Calculating the depths, Tsibeskov concluded that the table with legs depicts an early agricultural calendar, which recorded the time of ripening of wheat and barley - 96 days (Tsibeskov V. P., 1984., p. 19). The calculation of days, according to the researcher, was carried out by phases of the month. Besides, the moon was a symbol of general formation and disappearance. The moon, says Tsibeskov, served as a significant sign of a change of seasons. When the full moon passed near both branches of the Milky Way - in the northern latitudes it was the height of summer when it was near the trunk of this "tree" - winter came. Of course, the researcher further notes, not only the full moon but also its crescents for a man of that time a reliable indicator of time, his horn, which was on both branches of the celestial tree, predicted the death of the earth in winter, when he was near a tree trunk - the earth was dominated by summer, there was a lot of food (ibid. p. 15). Further, according to Tsibeskov, the moon was a symbol of the eternal cycle, a symbol of dying and resurrecting nature. The moon was associated with animals, in particular dogs, the germination of grain by embryo - egg (ibid. p. 16). The emergence of his second work, which deals with semiotic analysis images, more and more often the use of the term "sign" instead of the old "symbol" indicate a gradual erosion of symbolic awareness and the search for new research

methods, the gradual attention to the signs themselves, rather than what is hypothetically worthwhile (Petrenko V. G., 1984., p.18).

Relationships between signs that find analogs in the environment with signs that do not have such analogs, allowed Videyko to propose interpretations of the lenticular oval, which has already attracted the attention of Bogaevsky and Rybakov, like ears of wheat (Videyko M. Y., 1989. p. 47). In her favor, the researcher interprets single images of plants as signs - symbols of barley, and dots with shoots - as images of peas. The cups, according to Videyko depict a cycle of fieldwork: sowing, growing, and harvesting. The image next to a plant ("barley") and a lenticular oval ("wheat"), according to the researcher, reflects the existence of fields sown separately by these crops. On the bowls, which depict whole groups of these signs, the idea of prosperity, storage of crops is depicted. According to the researcher, the images of horizontal spikelets of the lower "underground" layer on biconical and crater-like vessels are connected with the storage of the crop in grain pits. In general, Videyko suggests that ornamented pottery with signs-symbols played an important role in the transmission of socially significant information, but the Trypillia tribes did not create their writing, even if they had several prerequisites for this (ibid. p. 48).

The article by Markevych is devoted to another "code" of the Trypillia-Cucuteni community - anthropomorphic, its bright manifestation - anthropomorphization of the ware. The researcher divided this ware into two groups. The first is a conditionally realistic vessel depicting either a female figure from shoulders to heels or two female bodies standing back to back (Markevich V. I., 1989, pp. 26-28). The second group - pear-shaped utensils with or without stands, two-tiered utensils, as well as bomb-shaped cups, spoons, and ladles (ibid. p. 34-35). According to Markevich, anthropomorphic vessels, consisting of images of two women, embodied the image of the supreme goddess - a woman of the Trypillia pantheon, who appears in two guises (ibid. p. 29). The provision of anthropomorphic features to a large number of Trypillia utensils is connected with orders that were to beg the supreme goddess for the benefits of life. The ornament on such a vessel, according to the researcher, consists of elements associated with the cult of fertility. Besides, the features of anthropomorphism and the presence in the ornamental system of a spiral - a snake (a "benevolent" snake) were intended, he believes for protection of what was stored in the dishes from rodents and other pests.

The collection of works on the spiritual culture of pre-written societies on the territory of Ukraine includes several studies on the Trypillia-Cucuteni worldview. They fully used the last reserve of symbolic awareness, namely a mostly complete systematization of signs or sign combinations had to be analyzed. Thus, in the article by Movsha, devoted to anthropomorphic particular figures on the dishes, 73 images are taken into account, 64 of them are painted, and 9 are applied by the technique of carving gray clay. From these images, taking into account the position of the hands and other stylistic features, 10 main types of single figures and 13 variants with symbols-attributes, as well as 7 paired figures (Movsha T. G., 1991. p. 46). Symbols-attributes allowed Movsha to combine images into three semantic-functional groups. The first group consists of agricultural symbols. These are figures with plant features, whales with a "comb" under the clothes, as well as with a disk or a ball on the head (ibid. p. 41). To the second group, Movsha attributed drawings with hunting symbols, noting that they are single. These figures in horned masks or with a bow as well as figures next to which animals are drawn (ibid., p. 44-45). The researcher included drawings with pastoral symbols in the third group. This, says Movsha, is so far the only image of a cow with calves and a man with raised hands. Above the animal-drawn wavy lines - snakes (ibid. p. 45).

The work of Movsha is the first detailed classification of the Trypillia-Cucuteni signs taking into account all its contexts. To date, this is the most complete analysis of ventricular images. Besides, Movsha drew

attention to such a phenomenon as the return in stage II (Kostesti IV) to the labris-like field in which the figure is depicted. Besides, in the same field, anthropomorphic figures were drawn on the vessels of the Cucuteni AB2 - Trypillia BI - BII stage by Traian Dealul Fantanilor (ibid., P. 41). These and other observations allowed us to propose a hypothesis about the development of sign systems of the Trypillia-Cucuteni community, which is fundamentally different from evolutionary schemes, namely, its cyclical nature. This will be discussed in detail in Chapter VI. In this collection, Zbenovich's article is devoted to snake-like images on dishes. The researcher analyzed the evolution of these images from conditionally realistic to fully schematic. Zbenovich further discusses his previously expressed idea that the serpent in the Trypillia-Cucuteni society was associated with the otherworldly frightening force - the dragon. This image, according to the researcher, was formed during the "Neolithic revolution" through the realization of the connection between heaven and earth, which led to a combination of their symbols - snakes and the creation of a winged dragon (Zbenovich V. G., 1991., pp. 30 -31). Zbenovich notes the widespread use of images of the dragon in the neo-Neolithic cultures of the Balkans, which, in his opinion, indicates a simple tradition of images associated with mythology (ibid. p. 31). Dragon, according to Zbenovich, acted in mythology as the antithesis of the female Serpent Goddess could emit light, and was associated with solar symbolism (ibid. pp. 32-33).

Finally, the work of Tsvek is devoted to the worldview of the Trypillia population of the eastern area of the cultural and historical community. The ornamentation of utensils is perceived by the researcher as a system of icons that conveyed the worldview of the population of that time. The main ideas conveyed by them are interpreted by Rybakov - a sky with water reserves, changing seasons, the cycle of time, the cult of fertility, the idea of two goddesses, and the whole cosmogonic ornament is interpreted by Tsvek as a talisman. An important place in the study is given to anthropomorphic vessels with female and male features. Tsvek considers the ornament on the vessel from the Berezivka settlement as a solar-lunar cycle. Anthropomorphic vessels with feminine features, according to the researcher, reproduces the dualistic image of the goddess of fertility - the Great Bopina, associated with the image of a snake and the moon (Tsvek O. V., 1993., p. 86). Along with other rituals, which, according to Tsvek, took place in houses and sanctuaries, there is a cult associated with the manufacture of ceramics (ibid. p. 82).

OV Tsvek expressed her opinion on the hereditary connection of the ideas of the inhabitants of the eastern region of commonality with the early Trypillia tribes. This is an interesting and important idea, especially in the context of developments in culturology of observations on the conservation of archaic phenomena in language and material culture on the outskirts. The eastern area in relation to other regions of the cultural and historical community was one of the peripheral, so the study of sign systems in this region is very promising in terms of obtaining documentary evidence of "marginal" phenomena of the sign system and their comparisons and comparisons with sign systems of the western area.

Concluding the review of the literature on the semantic significance of Trypillia-Cucuteni ornamentation on utensils, we note that the symbolic awareness of the sign has achieved positive results, especially if we consider the phenomenon of ornament as an economically determined phenomenon. Based on the principle of additionality, this approach to cultural phenomena should be considered legitimate, but not comprehensive, because it would lead to a one-sided solution to an extremely complex problem. After all, many questions have remained outside the scope of economic-deterministic and retrospective-mythological (from the point of view of historical mythology) interpretations.

PERIODIZATION AND SYNCHRONIZATION OF TRYPILLIA-CUCUTENI SETTLEMENTS. STAGES BI - CII-γII

The issues of chronology and synchronization constantly attract the attention of Trypillia scholars. Recently, as a result of many years of archaeological research, there are chronological columns for the settlements of Northern Moldova (Markevich V. I., 1981., p. 55-68), Tomashivka group (Kruts V. O., Ryzhov S. M., 1985, pp. 45-56), Romanian Moldova (Nitu A., 1984. p. 96-97), local variants of the stage of CII-γII (Dergachev V. A., 1980), all major monuments of cultural community Chernysh E. K., 1982, p. 213-231), the proposed synchronization of Usatove and Majaky complexes (Petrenko V. G., 1989., p. 105-115; Movsha T. G., 1984., p. 10-23; Sorokin V. Y., 1990., p. 94-99; Bikbaev V. M., 1992. p. 112-115; Ryzhov S. M., 1993., p. 90-92). The issues of genesis and chronology of the Chechelnyk group are studied (Polishchuk L. Y., 1989., p. 48-49; Ryzhov S. M., 1993., p. 92).

Since the study of sign systems is carried out at the synchronous and diachronic levels, semiotic research must have well-defined chronological boundaries of the life of the settlements from which the ceramic complexes involved in the work originate. The columns proposed by Kruts and Ryzhov for the Tomashivka group, Gusev for the monuments of the Southern Bug (Gusev S. O., 1993., p. 124), Markevich -for Northern Moldova, Nitu for Romanian Moldova. The chronological-synchronization table, compiled by Chernysh for the monuments of the whole cultural and historical community, is taken into account in the present work. Nonetheless, since the creation of these synchronization and chronological schemes, new material has appeared, which allows clarifying, and sometimes significantly change the proposed relationship between the monuments of the CI-γI stage, especially in its later stage. Finds of "imports" in Maidanetske, Stina IV, and some other settlements further allow doing so. In addition to "imports", an important role is played by influences in the form of uncharacteristic for one or another studied ceramic complex schemes of painting and individual signs. In addition to symbolic influences, contacts between different local groups are determined through the analysis of the graphics of ornamental schemes and forms of utensils, i.e. typological and comparative methods traditional for archaeology.

Clarifying synchronization issues is important to reduce errors in the work. After all, differences in number and condition of preservation of dishes in itself may increase the number of mistakes. Moreover, an inaccurate conformation of different ceramic complexes over time also might result in inaccuracies. Therefore, the maximum approximation to the existing ratios of monuments in time will allow us to obtain the most correct conclusions about the development of sign systems at the (synchronous) level. This will allow us to study various phenomena of sign systems, such as territorial differences or similarities, manifestations of sign activity on the periphery of the cultural community, as well as its manifestations in areas where migration or cultural impulses are likely to occur.

The earliest ceramic complexes used in the work come from the settlements of the Dniester-Bug interfluvium Nemyrivske and Stanislavka. According to Polishchuk, these settlements belong to the final phase of the middle stage (BII) (Polishchuk L. Y., 1989., p. 20). According to the style of paintings, ceramic materials from these settlements find analogies among the utensils from Rakovets. Unfortunately, there are few vessels from the excavations of these settlements, which greatly complicates the conduct of statistical-typological and semiotic studies. Very little material has been published from Rakovets itself, which also allows us to get only a general idea of the sign system of this settlement (Popova T. A., 1989., Fig. 2-5). Monuments of the same type include the settlements of Florești V, the materials of which were recently published (Todorova T. D., 1992., p. 58-72; Popova T. A., 1989., p. 143-148). Thus, monuments of the Rakovets type belong to an earlier time than Volodymyrivka, to the very beginning of stage BII.

Recently, they have been allocated to a separate Rakovets group, which in its development had two phases - early and late (Ryzhov S. M. (b)., 1993., p. 91-92). According to Ryzhov, they advanced to the Bug river basin at an early stage. It was at this time that the settlements of Nemyrivske and Stanislavka were founded.

The analysis showed that many signs of the Rakovets group of the early phase have certain analogs among the images of the later Volodymyrivka group. These are signs in the form of a sloping ribbon filled with lines and two black circles on its sides; black circles and black-painted lenticular ovals. Note that such signs are the most common in the painting systems of these two groups. Also common for this group are images in the form of black circles and lenticular ovals, images of ovals on the handles of dishes, drawings of moon-shaped horns up and down (in one tier), located horizontally. More, typical for the Volodymyrivka (and later Tomaszow's) group of images of small black circles on the sides of other signs, moon-shaped signs on top of each other, lenticular signs in the centers of ovals and hemispheres. Along with the described signs of the early phase of the Rakovec group, there are signs that are not common in the sign system of the Volodymyr group but occur in later sign systems of the CI-γI stage of the settlements of the Petreny group. According to researchers, the settlements of the second phase of the Rakovets group (such as Mereshovka Chetetsue III, Brynzeny VIII) served as a basis for the formation of the Petreny group (Sorokin V. Y., 1990., p. 98; Ryzhov S. M. (b)., 1993., p. 91). We assume the possibility that because of their sign systems, the Petreny group appeared with images of straight and oblique crosses in combination with black or red circles between the lines, as well as moon-shaped signs and black circles on the sides of wavy ribbons.

In the late phase, the monuments of the Rakovets pear appeared in the Bug basin and reached Western and Eastern Volhynia (Ryzhov S. M. (b)., 1993., p. 92). Thus, according to the logic of such an understanding of the cultural and historical situation of the beginning and middle of the BII stage, such settlements as Volodymyrivka, Voroshilovka, and Nezvysko III are correlated with the late phase of the Rakovets group. These are monuments on which extensive archaeological excavations have been carried out, and ceramic materials from them have been used in our work. Regarding the synchronization of these settlements, there is no unanimous opinion of researchers. Chernysh synchronizes Nezvysko III and Volodymyrivka (Chernysh E. K., 1982. p. 173). It seems, that Gusev also synchronizes them by adding Voroshylivka, since in the text of his work this researcher determines their synchronization (Gusev S. O., 1993., p. 121). In the chronological table, the researcher correlates Volodymyrivka with Brynzeny VIII as monuments that appear later than Voroshilovka and Nezvysko III (ibid. p. 124). Also, Markevich synchronizes Volodymyrivka with Brynzeny VIII (Markevich V. I., 1981., p. 67).

Ryzhov synchronizes post-Volodymyrivka monuments with Brynzeny VIII of the Nebelivka group, to the first phase of which the researcher, along with other settlements, refers to Pischana. Brynzeny VIII is then synchronized with the second phase of the Rakovets group, where he also includes Nezvysko III (Ryzhov S. M. (b)., 1993., p. 92). According to Ryzhov, settlements of the Voroshylivka type are synchronized with the monuments of the Nebelivka group (Ryzhov S. M. (a)., 1993., p. 112).

Based on the presented research, there are several options for synchronizing these settlements. On one hand, Nezvysko III, Volodymyrivka, and Voroshylivka are synchronous. On the other, Volodymyrivka is an earlier settlement, and Nezvysko III and Voroshylivka are later. Right now, it is difficult to determine which of these options can be considered more likely. It is still unknown if the authors can manage to get acquainted with the materials of the settlements of Volodymyrivka, Voroshylivka, and Nezvysko III, the pottery of other settlements, especially such important ones as Mereshivka - Chetetsue and Brynzeny

VIII. Very few utensils from these settlements have been published so far, so it is impossible to compare them with the known ceramic complexes.

Materials from Nezvysko III have several specific features. For example, in the paintings of dishes white paint is used in combination with black; red, white, and black, and red and black colors. Another feature is the drawing of oblique or vertical red, rarely white stripes crossing ornamental areas. Such a means of ornamentation was used on later monuments of the Shipintsi group. Lines or dots of white, red, or white and red paint outline the drawings painted in black. These and other features of the ornamentation of vessels from Nezvysko III allow us to explain such phenomena as the appearance of white paint in the paintings of monuments of the Voroshylivka type, as well as the appearance of craters painted with four-rayed "stars" on monuments of the same type. Gusev connects the origin of such ornamentation with the movement of the population from the Upper Dniester (Gusev S. O., 1993., p. 9,17).

Let's consider in more detail the influences of Upper Dniester on the paintings of dishes of the settlements of Voroshylivka and Volodymyrivka. As already mentioned, white paint was used in the paintings of dishes from Voroshylivka, it was applied in the same way as in Nezvysko III, the lines of white paint outlined the image made of black paint. But in the paintings of the dishes, we have no trace of the use of red paint or combinations of red and white paint. This is a rather mysterious phenomenon. Why was only white paint borrowed as a supplement to the black pattern? In general, the influences of Upper Dniester are distributed in a sample. For example, means of crater ornamentation such as the installation of four-rayed "stars" of painted lenticular ovals are typical of painting utensils from the settlements of Upper Dniester, in Voroshylivka, even though such craters with "stars" are not among the larger ceramic material. White paint on the paintings from this settlement is observed only twice. On the other hand, a large number of Upper Dniester influences, which are recorded on the ornamentation of Volodymyrivka, were not found on the pottery from Voroshylivka. The images of large black circles in the "Tangentenkreisband" schemes are shown, and the tangents in these schemes, as in the paintings from Nezvysko III, are directed both to the left and to the right; use of signs in the form of a lenticular oval, inside which there were negative or negative-positive vertical wavy bands. Such signs often occur among the ornamentation of Nezvysko III. How to explain these differences in the perception of influences that seem to have come from one source? It is possible that the masters of the two tribes had some restrictions, according to which they chose only certain signs, schemes, and means of ornamentation from the sign system, which brought with them people from Upper Dniester. The use of cups with "front" painting and a small number of utensils with deepened ornament is also observed in both settlements. It is possible that the fragment of the vessel (crater), painted with white paint, belongs to the "imports" and comes from settlements of the Voroshylivka type.

Monuments such as Nezvysko III, Voroshylivka, and Volodymyrivka group are chronologically located after the existence of monuments of the first phase of the Rakovets group. After them, there were still settlements of the Nebelivka group of the final of the BII, which arose based on the traditions of the Volodymyrivka group (Ryzhov S. M. (a)., 1993., p. 101-114). In our work utensils from the settlement of Pischana are used (it belongs to the late phase of Nebelivka group). After Voroshylivka in the Middle Bug basin, there were monuments of the Nemyrivka type (Gusev S. O., 1993., p. 121-122), which may have served as one of the components of the creation of early monuments of the Chechelnyk group. After Nezvysko III, the monuments of the Shipintsi group continued to exist in the Upper and partly in the Middle Dniester. At the end of BII in this region dates a ceramic complex originating from the settlement of Konovka (Shmagliy M. M., Ryzhov S. M., Dudkin V. P., 1985., p.51).

The monuments that preceded the creation of the Petreny group are still very poorly published. It is indicated that it was formed based on monuments such as Mereshivka Cetățuia III and Brynzeny VIII (Sorokin V. Y., 1990., p. 98). Middle Dniester was a zone of contact between the two groups at the end of the BII stage. This is evidenced by the already mentioned ceramic complex from the settlement of Konovka (Shmagliy M. M., Ryzhov S. M., Dudkin V. P., 1985., p. 42-52). Among the forms of utensils and their ornamentation are the features characteristic of the classical monuments of the Petreny type. First of all, it is a large number of pear-shaped and biconical utensils, decorated with the scheme "Tangentenkreisband". The signs in the ovals that are part of these compositions often appear on such schemes of Petreny monuments, including black and red circles, painted and unpainted semi-painted crosses. Ovals are often empty, which is also characteristic of this scheme of the Petreny group. The Petreny signs include double moon-shaped signs in the center of the 8-shaped arc on the crater. Such a sign is also quite common on Petreny craters, for example, in Bernashivka.

A large number of utensils, its ornamental patterns, and signs from Konovka have features characteristic of the Shipintsi group. These are amphorae of elongated proportions with rounded shoulders, a narrow neck, and curved crowns, painted with ovals, which are connected by tangents. Free zones are occupied by volutes. On the second tier of vessels sometimes painted lenticular ovals with negative wavy ribbons on the inside. These ovals are connected by horizontal wavy ribbons. The ornament in the form of volutes, arches ("knitting"), which go one after the other, is peculiar to the monuments of the Shipintsi group. An interesting peculiar synthesis of the two traditions can be traced in the scheme group of black circles. But the triangular areas formed during the connections of black circles by tangents were not filled with black paint, leaving small negative semi-edges, as was usually done in the paintings of classical Shipintsi monuments, and were filled with a large number of ovals, semi-ovals, lenticular ovals, etc. Such a feature is inherent in Petreny painting's "Tangentenkreisband". Perhaps the influence of such syncretic monuments can explain the appearance of such schemes in the paintings of settlements on the right bank of the Prut and their further development on later monuments such as Valea Lupului II and Cucuteni B II-I.

As another manifestation of the synthesis of two sign systems, the Petreny, and the Shipintsi, we should cite the painted biconical vessel, painted with the scheme "Tangentenkreisband". In the ovals are cross-shaped "stars". Such signs, as already mentioned, are characteristic of the paintings of craters of the Shipintsi subgroup and occur quite often among the vessels from Konovka. Bernashivka belongs to the classical settlement of the Petreny local group. In the ceramic complex of the settlement, we have utensils, which are either typical of the Shipintsi subgroup or have certain influences from the ornamental traditions of these monuments.

The direct "imports" from the more northern settlements of the Shipintsi group include a cup painted with horizontally arranged painted hemispheres. They resemble bumps that intersect with wide oblique red stripes. Such a means of ornamentation, as already mentioned, is often found on ceramics from northern monuments, starting from the BII stage (Nezvysko III). There is also a vessel from the settlement of Shipintsi B. Among the vessels from Bernashivka there was a vessel on which large black circles connected by tangents were applied - also "import" from Shipintsi monuments. Further, separate "binoculars" were found, the lower cups of which are much smaller than the upper ones. Such forms of binoculars are also characteristic of the settlement of the Shipintsi group (Kandyba O., 1937-8, 95-96. pp. 139-148). Besides, on the Bernashivka sites, we have craters painted with four-rayed "stars", also characteristic of Shipintsi complexes. In addition to direct "imports", there are other effects of Shipintsi ornamentation on Petreny schemes, for example, arcs in the "owl face" scheme, filled with horizontal

lines intersected by vertical black lines. This is how most of the ribbons on the paintings from Shipintsi B were filled, but there are unknown schemes of “owl face” painting.

According to several archaic features in the ceramics from Bernashivka and Petreny, these two settlements can be synchronized. These include: utensils, red filling of one of the 8-shaped arches, 8-shaped arches painted in bunks on a biconical vessel, handles on the outside of the cut-conical bowl, a cup with low shoulders, bowls with an external painting. There were funnel-shaped crowns of many vessels, bowls with an external painting, vertical 8-shaped arches with an extension inside. Archaic features include the painting of cups by the scheme “facial motif”. There is no conclusive categorization of the cups of Bernashivka. Consequently, the settlement of Bernashivka can be synchronized, on the one hand, with monuments such as Shipintsi B, and on the other, due to several archaic remnants in the ceramic complex and the presence of similar remnants on dishes from Petreny, with Petreny type monuments.

It should be noted that the settlements Shipintsi B and Petreny have long attracted attention in synchronization studies: they were attributed to the stage of BII (Vinogradova N. M., 1972., p. 54) and stage CI-γI (Markevich V. I. 1981., p. 58; Chernysh E. K., 1982., p. 172). In the recently proposed periodization and synchronization of monuments of the Petreny group Shipintsi B, Petreny and Bernashivka are referred to as the second stage of the middle phase of the group's existence (Ryzhov S. M. (b)., 1993., p. 91). Sources of formation of the Chechelnyk group at this time can be outlined only in the most general features. They point to monuments such as Krynychka as the basis of the Chechelnyk group, as well as to the influence of the Petreny group on the early phase of its existence (Ryzhov S. M. (b)., 1993., p. 92). Influence from the Volodymyrivka group is also noted (Polishchuk L. Y., 1989., p. 48-49).

Many elements of ornamentation indicate a certain influence on its formation by the Rakovets, or later Volodymyrivka group. Thus, among the paintings of the dishes of the Chechelnyk group, there are ribbons filled with elements that resemble arrowheads; with their sharp ends, they are directed both to the right and to the left. Similar elements are inherent in the paintings of Volodymyrivka group, among the Petreny ornamentation they are almost non-existent. Elements of ornamentation, such as images of wavy ribbons or lines on the outside of the crown of dishes from Chechelnyk monuments, can also be explained by the influence of the Volodymyrivka group.

Monuments of the middle phase of the Petreny group are synchronized with such settlements as Cherkasiv Sad II (Chernysh E. K., 1982., p. 216) and Chechelnyk (Ryzhov S. M. (b)., 1993., p. 92). The correctness of such synchronization is evidenced by the Chechelnyk “imports” from the Bernashivka settlement. The forms of ware of the scheme of a list already have all features inherent in the wares of these types. One vessel has an extended “turnip-like” body. It is painted with the “Tangentenkreisband” scheme. The area of the painting at the top is limited by a ribbon filled with vertical lines, which is almost not typical for filling such ribbons in the Petreny group, instead of the Chechelnyk group. The second “import” is a biconical jug, divided into two tiers and painted with metopes filled with vertical lines. Metopes are connected by tangents.

The influences of both the Petreny and Tomashivka groups can be seen in the paintings of pottery from the settlements of Cherkasiv Sad II and Chechelnyk. Petreny influences include zoomorphic images in medallions in the “Tangentenkreisband” schemes, dishes painted with metopes, combined with tangents that depart from them in opposite directions, paintings with festoons in the lower tier, and horizontal lines in the second. Tomashivka influences include a sign in the form of a festoon located in an oval. Such

signs occur already in the first phase of the Tomashivka group. The sharp-edged forms of the Chechelnyk group's cups, which are decorated with a characteristic ornament of the Tomashivka group in the form of horizontal arches with an extension inside, can also be explained by the influences of the Tomashivka monuments (Polishchuk L. Y., 1989, p. 49).

As already mentioned, the synchronization of the second phase of the Petreny and the first phase of the Tomashivka group (which are all other phases) is significantly complicated by large stylistic differences in the ornamentation of ceramics of the two groups (Bykbaev V. M., 1992, p. 114). Tomashivka and classical Petreny settlements have not been found yet. The exception is a small sharp-edged cup, originating from the settlement of the time existence Petreny - Pîrjota BII. In form and content, he comes from the Tomashivka group (ibid. p. 114). Unfortunately, the mural is not preserved in the cup. But it should be noted that if the painting was preserved, it would do little to address the issues of synchronization since the ornament of Tomashivka sharp-edged cups is quite stable for a long time. In the settlements of the late phase of the Petreny group, the number of "imports" is growing somewhat. The ceramic complex of Lipchany is interesting in this regard. This settlement is attributed to a time later than Petreny, and earlier than the settlement of Stina IV (Zbenovich V. G., Shumova V. A., 1989., p. 105).

Among the pottery from Lipchany there are dishes with features characteristic of the settlements of the Right Bank of the Prut river (ibid. p. 105). It is an amphora of elongated proportions. It is painted with wide white ribbons outlined by black lines. White ribbons near the handles of the amphora form ovals, redrawn diagonally. Between them are two triple oblique crosses. This type of tableware has similar analogies among the ceramics from the Cucuteni monuments of Poduri-Dealul Ghindaru, Veleni-Piatra Neamț (Nitu A., 1984), Galați (Dumitrescu V., 1979). Crater, painted by the scheme "Tangentenkreisband" in the upper tier of the painting, on the crown, and lying double S-shaped arches (Zbenovich V. G., Shumova V. A., 1989., p. 12., Fig. 12). Analogies to it can be found among the vessels from Veleni-Piatra Neamț and Gelaeshti Nedeia. Schemes of painting "Tangentenkreisband" with small black circles in the center also have direct analogies among the ceramics of the western Cucuteni monuments Cucuteni BII-1 and the later settlement Valea Lupului II (Dinu M., 1957) and Cucuteni BII-2 (Nitu A., 1984).

The pottery from the settlement of Veleni-Piatra Neamț has the most similar typological and stylistic features to the Lipetsk pottery. The similarity between the two ceramic complexes is also observed in the signs. For example, ovals filled with a grid included in the "Tangentenkreisband" schemes and arcs with two black circles at the ends. In Lipchany this sign is included in the anthropomorphic image on a large biconical vessel with a wide neck (Zbenovich V. G., Shumova V. A., 1989., p. 102. Fig. p. 13), and in Veleni-Piatra Neamț three such signs are depicted inside a cylindrical-conical bowl (Cucoș S., 1981). The findings of two cups originating from the settlements of the Chechelnyk group testify to this. One of them depicts two animals. The tails of these animals end in black circles, similar to how the tails of animals were formed in the images from Cherkasiv Sad II (Polishchuk L. Y., 1989., p. 42., Fig. 13). The lower part of the cup is decorated with a typical for the Chechelnyk group of painting scheme of cups – horizontal S-shaped arches without thickenings inside. Images of animals are divided by metopes formed by arcs, below and above the metope - painted half-painted - "humps". The middle method is filled with horizontal rows of dots. The semicircles were outlined with dots (Zbenovich V. G., Shumova V. A., 1989. p. 103., Figs. 4, 2).

The very forms of metopes, their filling, animal stylistics, the ornamentation of the lower tier of the painting are not typical of the Petreny group cups, but all these features are characteristic of cups from Chechelnyk settlements. Such signs occur in the settlements of the Chechelnyk (as well as Tomashiv) groups and are not typical of the sign systems of the Petreny group. This is a biconical vessel with a

tangential-metope painting, typical of the Tomashivka group. The painting has one stylistic feature, which is inherent in the second phase of the existence of Tomashivka settlements, namely: the lines surrounding the great black circles. In the pottery paintings of the Tomashivka monuments of the second phase, these lines often end in the form of "leaves". There are no such features in the ceramics of the III phase of the Tomashivka group. Thus, the settlement of Lipchany is synchronized with the settlements of the II phase of the Tomashivka group of the Dobrovody type. Among the pottery from the settlement of Lipchany, there were several more Tomashivka "imports": a sharp-edged cup without a painting with cut-conical bowls with murals typical of the long existence of the Tomashivka group.

The settlement of Stina IV belongs to the last phase of the existence of the monuments of the Chechelnyk group. A large number of Chechelnyk pottery, along with the utensils typical of Petreny monuments, testifies to the syncretic nature of this settlement. In addition to this pottery, there were also some "imports" from Shipintsi monuments, "imports" and influences from Tomashivka settlements. The settlement of the Petreny group - such as Varvarivka XV, Shur I. All this makes the ceramic complex of Stina IV extremely valuable for synchronization research. With its help, it is possible to determine the upper limits of the existence of the Chechelnyk, Petreny, Shipintsi, and, possibly, Tomashivka groups.

Ceramics from Stina IV mostly consist of Chechelnyk features. A large number of Chechelnyk elements of ornamentation, in comparison with others, testifies in favor of the fact that the Chechelnyk population was a kind of substrate in Stina IV. The population of Petreny and Tomashivka was superimposed on this substrate. The life of a certain Tomashivka population in Stina IV is evidenced by a vessel made of dough, but in terms of form and painting - typically Tomashivka. It is a biconical jug with handles, painted with a metope-tangent scheme, and a cup, on which there are horizontal S-shaped arches with an extension in the middle. Tomashivka signs were used in the sign system of Stina IV. One of them in the form of a lenticular oval filled with an oblique grid is applied to a typical Petreny cut-conical bowl, painted with the scheme in the form of the number "8". The second sign in the form of a plant is drawn in the center of the "triglyphs" of the Chechelnyk cups. "Imports" from Tomashivka settlements are typical of the later phases of their existence. These include two amphorae with a "front" painting and a crater with wavy lines on the crown.

The synchronization of Stina IV with Maidanetske (Shmagliy M. M., Videiko M. Y., 1987, p. 68) is based on these "imports". In favor of such synchronization, we can also cite imported truncated-conical bowls from Maidanetske, which have a kind of painting in the form of double segments, which go beyond the other elements. Such paintings are often found in the bowels of Stina IV, Dobrovody group, and has the form of a biconical vessel painted with metopes and tangents. A wavy ribbon is depicted under the handles of a biconical vessel painted with festoons in the upper tier, and amphorae made of muddy dough with handles under the crown, which, unfortunately, have not survived.

The number of "imports" in Maidan is impressive. Two or three "imported" vessels were found at almost every site of this settlement. In addition to direct "imports", Maidanetske has shown influences in the form of Chechelnyk paintings painted on Tomashivka forms of utensils, and vice versa, Chechelnyk forms of tableware have typical Tomashivka painting schemes. Besides, some Chechelnyk signs were painted inside Tomashivka paintings. It should be noted that among these "imports" there are no turnip-like utensils painted with a two-tier scheme "Tangentenkreisband" and a two-tier metope-tangent painting, which are quite common among the utensils of Cherkasiv Sad II and Chechelnyk.

It can also be noted that among the pottery of these Chechelnyk settlements there is not a single "import" from the Tomashivka group. Therefore, the idea of the existence of another, late phase in the Chechelnyk

group can be considered valid (Ryzhov SM (b)., 1993. p. 92). However, referring to the settlements Kyrylivky and Bilyj Kamin is considered problematic due to the lack of materials. Some settlements come late phase "Import" in Maidanetske, and perhaps the exact people from Petreny and Tomashivka lived in exile Stina IV.

Judging by the rather large number of "imports", the stylistic features of dishes of this phase include the following features: the absence of a small number of turnip-shaped dishes with a two-tiered painting "Tangentenkreisband" and tangent-like schemes, widespread distribution of scalloped paintings in the second tier, frequent use of labris-like "triglyphs", which in the early Chechelnyk monuments had mostly rectangular outlines. How far did the upper time boundaries of the Chechelnyk group reach? This is a very important issue, due to the presence of ceramic complexes, where the "imports" of the last phase III occur along with Petreny, Tomashivka, and even Shipintsi "imports", we can outline the upper chronological boundaries of these groups.

The answer to this question may be published "imports" from the settlement of Varvarivka XV. We would like to draw attention to the conical bowl, painted with segments that go one after another, and a biconical wide-necked jug, painted with "wave" painting (Markevich V. I., 1981. p. 31., Fig. 34, 14., p 32., Fig. 35.8). Both "imports" in the form and style of paintings are the most common among the dishes of Chechelnyk monuments. Unfortunately, we could not find them during the exploration of this collection. In general, it should be noted that the pottery from Varvarivka XV is often depicted inaccurately, so the presence of Chechelnyk "imports" in the village of Varvarivka XV should be questioned. On the other hand, on the ceramics of Stina IV, as already mentioned, some signs are not typical for the sign systems of Petreny, Chechelnyk, and Tomashiv settlements. This is a W-shaped sign depicted on a biconical vessel, which is painted with the scheme "owl's face" (Makarevich M. L., 1960), and a V-shaped sign depicted at the end of the segments, one on top of the other in a truncated-conical place. W- and V-shaped signs were first found on the vessels of the settlements of Northern Moldova Varvarivka XV (Markevich VI - 1981. p. 59) and Shura I (Bykbaev V. M., 1989. p. 57., Fig. 3. 3.12). They belong to the second half of stage γ I. The appearance of monuments such as Shur I, close (with some differences) to Varvarivka XV, associated with processes of destabilization of existing relations in the first half of stage CI- γ I system of territorial groups and intertribal relations (Bikbaev V. M., 1989. p. 60). In addition to the signs, among the ceramics from Stina IV, we have a truncated-conical bowl, painted with cruciform ovals. The ribbons that form ovals are filled with thin lines. Such paintings, as well as W- and V-shaped signs, can be explained by the influences of barbarian-type monuments that appeared in the west and coexisted for some time with the end of the last phases of the Petreny and Chechelnyk and Tomashivka groups.

Among the ceramics from the Tomashivka settlement of Maidanetske, there is also an image of V-shaped signs. One such sign is made in an in-depth technique. It is applied on the outside of a typical Tomashivka truncated-conical bowl, closer to the bottom. Two superimposed V-shaped signs are drawn inside another truncated-conical bowl. A group of vertical rows of V-shaped signs was found on a truncated-conical bowl in the scheme, which has the form of strips coming one after another, with the image of moon-shaped signs at their ends. One bowl depicts wide V-shaped signs, filled with parallel lines and dashes along the contour. Such signs are also found on the pottery from Varvarivka XV. This is a cut-spherical bowl, painted inside a cross-shaped composition. Between the ribbons that form a double-cross, there are elongated ovals, on the edge of the bowl is applied triangles. The second bowl has a truncated-conical shape with a profiled crown. It is painted with lenticular ovals, the arcs of which are filled with parallel lines. Along the edge of the bowl, closer to the middle, there are triangles, and closer to the edge - lines. Filling the arches that form ovals with a red line does not seem to be typical of

Chechelnyk monuments. Although bichrome occurs among the dishes of the Chechelnyk group, the red lines on its paintings were not included in the design of the ovals. Besides, the vertical holes of the handles are not typical for Chechelnyk ware. Instead, the pottery from Varvarivka XV has all these features.

The ceramic complexes of the end of CI-YI reflect some convoluted processes. At this time, new territorial groups began to form. In Northern Moldova, there were monuments such as Varvarivka XV - Shur I. At the same time on the outskirts of the Petreny group still, lived some Petreny settlements. At the same time, there are upper borders of the Chechelnyk and Shipintsi groups (?). This is evidenced by Shipintsi "imports" in the settlement of Stina IV. It looks like a biconical amphora, painted in the lower tier by the "Tangentenkreisband" scheme, which includes large black circles, and diagonal red lines on a white background in the upper tier. Varvarivka XV is chronologically correlated by some researchers with the settlement of Romanian Moldova Valea Lupului II (Markevich V. I., 1981. p. 67; Chernish E. K., 1982., p. 172). According to another synchronization, Valea Lupului II appeared a little earlier than Varvarivka XV (Bikbaev V. M., 1992., p. 114). This point of view seems to be more accurate. Among the dishes from Valea Lupului II, there are many features inherent in the ceramics of earlier Cucuteni monuments. These include biconical cups with metope painting. There are no such forms and schemes of painting in the ceramic complex from Varvarivka XV. Biconical ware from Valea Lupului II has sharply bent crowns. At that time in Varvarivka XV, most of the dishes had a spherical-night shape and high throats with curved tulip-shaped crowns.

Perhaps the main component in the formation of settlements such as Varvarivka XV were tribes from the Right Bank of the Prut, who lived in settlements such as Valea Lupului II. They brought with them new forms of utensils, such as cut-spherical bowls, utensils with a turnip-shaped body, painting schemes divided by vertical ribbons into metopes, and so on. Also, the tradition of significant use of red paint occurred, images of wavy ribbons painted with it, and the location of these signs in the schemes "Tangentenkreisband", where they were drawn between tangents that previously remained empty. Among the sign system of Varvarivka XV, there are graphemes, the origin of which may indicate another component in the formation is the tradition of painting utensils in the settlements of the Upper Dniester and Prut. These include a sign in the form of a lenticular oval, filled with black paint and located in the second tier of the painting, as well as black circles in the schemes "Tangentenkreisband". However, the same signs occur among the paintings of Cucuteni monuments, for example, black circles in the schemes "Tangentenkreisband" are in the paintings of Valea Lupului II. Therefore, the source of these signs is difficult to identify.

West or north? It is possible that the two regions simultaneously influenced the creation of a kind of Varvarivka-type complex. In favor of the northern impulse stands the image of the plant (Markevich V. I., 1981., p. 31., Fig. 34,3), which, graphically, are similar to such a pattern from earlier Shipintsi monuments. Besides, we can cite the image of oblique ribbons in the second tier of the "Tangentenkreisband" scheme from Varvarivka XV. Similar signs are on the vessels from the Upper Dniester settlement of Bilche Zolote Verteba I (Kozłowski L., 1939). The existence of Varvarivka XV, Shur I, and related monuments is an important milestone in the chronology of the Trypillia-Cucuteni community. After them, large local groups disappear, such as Tomashiv and Chechelnyk. The formation of monuments of the Bădragii Vechi, the genetic basis of which were Varvarivka monuments, was completed (Markevich V. I., 1981, p. 61). Based on classical Shipintsi traditions, poorly researched monuments such as Bilche Zolote (Verteba I) were formed.

It should be noted that Bilche Zolote (Verteba) has two layers with painted ceramics. The lower layer, always with the above indicators, can be synchronized with the Bădragii Vechi (according to Markevich) of Northern Moldova, and the upper layer belongs to the monuments of Koshylivtsi Oboz type (Kandyba O., 1937., p. 7-9). From this layer comes a bone dagger (Hadaczek K., 1914), which has analogies among the finds from settlements such as Brynzeny III (Markevich VI -1981., p. 38. Fig. 50) and a sphere-conical amphora with paintings typical for monuments such as Koshylivtsi Oboz (Kozlowski L., 1939). The forms of Koshylivtsi can be primarily attributed to the Brynzen-Zhvanetsky traditions. Amphoras are spherical-conical with high necks and smoothly curved crowns. The bowls, like the Brynzen-Zhvanets, are painted with cruciform ovals, often with large triangles at the edges. The anthropomorphic image, which is on the same vessel, also finds analogies among similar drawings from settlements such as Brynzeny III - Zhvanets (Hadaczek K., 1914).

As for the question of the chronology of the settlement of Koshylivtsi Oboz, Chernysh quite rightly refers it to the time of existence of Brynzeny monuments (Chernysh E. K., 1982., p. 172). Attention is drawn to the differences that exist in the synchronization of Bădragii Vechi monuments and settlements such as Podei-Târgu Ocna. Thus, Markevich refers to them as "to the time between the Bădragii and Brynzeny phases" (Markevich V. I., 1981., p. 67). Chernysh synchronizes Bădragii monuments and Podei-Târgu Ocna (Chernysh E. K., 1982., p. 172). This synchronization seems to us more accurate. Its correctness is evidenced by "imports" from settlements such as Târgu Ocna-Podei in the ceramic complex of the Bădragii settlement of Pyrzhot X. It has the form of a vessel with a cylindrical-conical neck, which is painted with horizontal S-shaped loops. Such an ornament is typical of paintings from Târgu Ocna-Podei, but it is not among the Bădragii ornaments. Besides, a "frying pan" was found in the settlement of Hancăuți I. For the late Trypillia-Cucuteni monuments, chronological columns proposed by Moldovan archaeologists are used in the work (Markevich V. I., 1981., p. 62-67; Dergachev V. A., 1980., p. 77-93), as well as chronological developments for Usatove and Majaky complexes, proposed by Petrenko (Petrenko V. G., 1989., p. 105-115. Fig. 39).

As for the synchronization and periodization of these monuments, we do not have material that would help in their refinement. Therefore, we present the main conclusions from the chronological studies that will be used in the work. According to this study, the materials from the Ofatinți cemetery, due to some unknown stage of development, are associated with monuments such as Varvarivka XV, while the cemetery itself has four horizons (Dergachev V. A., 1980., p. 80, 83). Usatove is genetically related to the first horizon of the Ofatinți cemetery and then develops quite independently (Zbenovich V. G., 1972; Movsha T. G., 1972; Derrachev V. A., 1980). Brynzeny monuments also come from Varvarivka XV through the Bădragii stage (Markevich V. I., 1981. p. 62; Derrachev V. A., 1980. p. 80). They are synchronous with the early horizons of Ofatinți and Usatove cemeteries (Derrachev V. A., 1980, p. 81).

Monuments of the Gordinești type are related to the Brynzeny ones and are synchronized with the later horizons of the Ofatinți and Usatove cemeteries (Dergachev VA - 1980. p. 84). Usatove and Majaky complexes are synchronous (Petrenko V. G., 1989., p. 109. Fig. 39). Thus, observations of "imports" in ceramic complexes of settlements of the BII - CI-γI stages allowed us to make some clarifications in the existing synchronization and chronological columns of monuments and offer them in a slightly modified form, as shown in our chronological synchronization table below.

	The right bank of the Prut river	Interfluve of the Prut and Dniester rivers	Middle Dniester	Upper Dniester	Lower Dniester at the black sea	Middle Bug and Prut region	Bug- Dnipro interfluve
CII-γII 3500-2800 BC		Gordinești	Stina I, Zhvanets		Usatove II, Ofatiți II		
		Brînzeni III	Zhvanets	Koshilivtsi Oboz, Bilche Zolote Verteba II	Usatove I, Ofatiți I		
CI-γI 3900-3500 BC	Târgu Ocna-Podei	Hancăuți I, Bădragii Vechi	Konovka 1, 2	Bilche Zolote Verteba I			Tomashivka
		Varvarivka XV,	Stina IV				Maidanetske
	Valea Lupului II					Chechelnyk	Talne II, Talianki
	Văleni Piatra Neamț		Lipchany				Dobrovody, Chycherkozivka
		Petreny	Bernashivka	Shipintsi B		Cherkasiv Sad II	Sushkivka
BII 4100-3900 BC			Konovka				Kolodyste, Pischana
				Nezvysko III		Voroshylivka	Volodymyrivka
			Rakovets Florești V		Stanislavka Nemyrivske		

Table 1: Relative chronology of Trypillia-Cucuteni settlements of stages BII-CII, the materials of which were used in the work

SOURCES. GENERAL CHARACTERISTICS

Before we begin the analysis of the sign systems of the Trypillia-Cucuteni cultural and historical community, we will describe the sources used in the work. Below are a few preliminary remarks.

In cases where the ciphers on the vessel or its fragments allow to consider the vessel by complexes (i.e. by excavation sites), this is indicated in the text and the histograms. When such an analysis is impossible - the total number of vessels is taken. This also applies to situations, whenever the published material is used and its affiliation to certain sites is not specified, the vessels were obtained during old excavations, or when only a few painted vessels remained. Since large series of utensils are needed for semiotic studies of the sign activity of the Trypillia-Cucuteni population, and there are quite a few of them from different horizons of Ofatinți and Usatove complexes, the ceramics of these cemeteries of early and late horizons are consciously combined as a product of (hypothetically) one tradition. Painted utensils from burial mounds of the Usatove type are also combined. This makes it possible to obtain a series of similar utensils (where the available material allows) and a general idea of the sign systems of Late Trypillia in specified regions of the cultural and historical community.

In many cases, the total number of dishes and the number of dishes taken on the sites do not match. This is because a certain number of dishes come from the pits or the surrounding space near the sites. On some dishes there are no codes, which does not allow them to refer them to a specific site, thus they are included in the total number of dishes.

Stage BII Nemyrivske (Odessa region, Baltskiy district).

The work uses ceramics obtained during the study of the settlement by an expedition led by Shmagli M. M. in 1986. 36 vessels were involved in the analysis. The condition of the material is satisfactory, many dishes are highly fragmented.

The collection is stored in the funds of the Institute of Archeology of the National Academy of Sciences of Ukraine, Kyiv.

Stage BI. Stanislavka (Odessa region, Baltskiy district).

The settlement was explored in 1986 by an expedition led by Shmagli M. M. 50 vessels were involved in the analysis. The condition of the pottery is satisfactory, many dishes are highly fragmented.

The collection is stored in the funds of the Institute of Archeology of the National Academy of Sciences of Ukraine, Kyiv.

Stage BI. Nezvysko (Ivano-Frankivsk region, Horodenka district).

The work uses ceramics obtained during the research of the settlement by an expedition led by Chernysh K. K. in 1951, 1953-1954, 1956-1957. 515 vessels were involved in the analysis. The condition of the material is satisfactory, many dishes are fragmented.

The collection is stored in the funds of the Museum of Local History in Ivano-Frankivsk.

Stage BI. Voroshilivka (Vinnytsia region, Tyvriv district).

The work uses ceramics obtained during the study of the settlement by expeditions led by Zayets I. I. in 1982-1985, 1990. 144 vessels were involved in the analysis. The condition of the material is satisfactory. The ornament on many fragments of pottery was severely damaged by the conditions in the soil.

The collection is stored in the funds of Vinnytsia Pedagogical University and Vinnytsia Regional Museum of Local History.

Stage BI. Vladimirovka (Kirovograd region, Novoarkhangelsk district).

The work uses ceramics obtained during research expeditions led by Passek T. S. 1936, 1940, 1946-1947, and Yakubenko O. O. in 1989-1990. The analysis involved 447 units of utensils. The condition of the pottery is satisfactory, many dishes are highly fragmented. Preservation material enables the analysis of the used schemes of paintings and signs of utensils in each home (dwelling).

- From dwelling 3 a total of 22 vessels were analyzed;
- from the dwelling of 7-14 vessels;
- from the dwelling of 16-14 vessels;
- from the dwelling of 22-14 vessels;
- from the dwelling 2-51 vessel;
- from the dwelling of 6-17 vessels;
- from the dwelling of 10-19 vessels;
- from the dwelling of 17-40 vessels;
- from the dwelling 1 - 30 vessels.

The collection is stored in the funds of the State Historical Museum, Moscow; funds of the National Museum of History of Ukraine, Kyiv; funds of the Museum of Archeology and Ethnography of the Republic of Moldova, Chisinau.

Stage BII. Pischana (Cherkasy region, Talniv district).

The work uses ceramics obtained during the study of the settlement by expeditions led by Kruts V. O. in 1984 and 1988. 95 units of utensils were involved in the analysis. One dwelling was excavated, from which 88 vessels were used in the study. The condition of the material is satisfactory.

The collection is stored at the Institute of Archeology of the National Academy of Sciences of Ukraine, Kyiv.

Stage BI. Kolodyste (Cherkasy region, Talniv district).

The work used ceramics obtained during the study of the settlement in 1900 by an expedition led by Bilyashivsky M. F. In total, 56 vessels were involved in the analysis. The condition of the ceramics is satisfactory.

The material is stored in the funds of the National Museum of History of Ukraine, Kyiv.

Stage BI. Konovka (Chernivtsi region, Kelmenets district).

The work uses ceramics obtained during the study of the settlement by expeditions led by Shmagli M. M. in 1976, 1978, 1980. 157 vessels were involved in the analysis. The condition of the material is good.

- From dwelling 3 we have 82 vessels;
- from the dwelling 4-7 vessels;
- from the dwelling 7-40 vessels;
- from the dwelling of 12-28 vessels.

The collection is stored in the funds of the Institute of Archaeology of the National Academy of Sciences of Ukraine, Kyiv.

Stage VI. Petreny (Drochis district. Republic of Moldova).

The work uses ceramics obtained during the study of the settlement by Stern E. R. in 1902-1903. 207 units of utensils were involved in the analysis. The state of preservation of the material is satisfactory. Many dishes are highly fragmented.

The collection is stored in the funds of the Odessa State Archaeological Museum.

Stage CI. Bernashivka (Vinnytsia region, Mohyliv-Podilskyi district).

The work uses ceramics obtained during the study of the settlement by expeditions led by Kolesnikov O. G. in 1989-1991, 1993. 929 units of utensils were involved in the analysis. 7 dwellings were excavated:

- From dwelling 1 we have 180 vessels;
- from the dwelling of 2-168 vessels;
- from the dwelling 3-195 vessels;
- from the dwelling 4- 61 vessel;
- from the dwelling 5-81 vessel;
- from the dwelling 6-148 vessels;
- from the dwelling 7-96 vessels.

The condition of the material is satisfactory.

The collection is stored at the Institute of Archeology of the National Academy of Sciences of Ukraine, Kyiv.

Stage CI. Lipchany (Vinnytsia region, Mohyliv-Podilskyi district).

The settlement was explored in 1985 and 1987 by expeditions led by Zbenovich V. G. and in 1991 by an expedition led by Kolesnikov O. G. 96 units of utensils were involved in the analysis. The condition of the material is satisfactory, many utensils are fragmented. On many of them, the ornament has not remained. From platform 1 we have 51 vessels; from the dwelling of 2-30 vessels.

The collection is stored at the Institute of Archeology of the National Academy of Sciences of Ukraine, Kyiv.

Stage CI. Stina IV (Vinnytsia region, Tomashpil district).

The work uses pottery from excavations of the settlement by an expedition led by Gamchenko S. S. in 1929 and by expeditions led by Makarsvych M. L. in 1958-1959. 220 units of utensils were involved in the analysis. The safety of the material is satisfactory. Many vessels are highly fragmented. From excavation 1 we have 15 vessels; from the split of 2-30 vessels.

The collection is stored in the funds of the Institute of Archeology of the National Academy of Sciences of Ukraine and the Archaeological Museum, Kyiv.

Stage CI. Chechelnyk (Vinnytsia region, Chechelnytskyi district).

The settlement was studied by Kosakivsky V. A., an employee of the Vinnytsia Museum of Local History, who in 1983-1985 collected material at the settlement before it was destroyed by the construction of a sugar factory. In 1990, an expedition led by Zayets I. I. excavated one dwelling of the settlement. 235 units of utensils were involved in our analysis. The condition of the ceramics is satisfactory. Many dishes are highly fragmented. From dwelling 1 we have 93 vessels.

The collection is stored in the funds of the Vinnytsia Museum of Local History.

Stage CI. Cherkasiv Sad II (Odessa region, Kodyma district).

The material from excavations of the settlement by expeditions led by Polishchuk L. Y. in 1983-1985 was used in the work. 272 vessels were involved in the analysis. The state of preservation of the material is good. Overall, 4 dwellings were excavated:

- from dwelling 1 we have 19 vessels;
- from the dwelling 2-27 vessels;
- from the dwelling 3-38 vessels;
- from the dwelling 4-40 vessels.

The collection is stored in the funds of the Odessa State Archaeological Museum.

Stage CI. Shipintsi (Chernivtsi region, Kitsman district).

The work uses dishes published by Child (Child G., 1923) and Kandyba (Kandyba O., 1937). 185 vessels were involved in the analysis.

Stage CI. Bilche Zolote Park III (Ternopil region, Borshchiv district).

The work uses dishes published by Kozłowski L. (1939) and Gimbutas M. (1973). 18 units of utensils were involved in the analysis.

Stage CI. Sushkivka (Cherkasy region, Uman district).

The work uses ceramics obtained during excavations of the settlement by expeditions led by Kozlovskaya V. S. 124 vessels were involved in the analysis. The state of preservation of ceramics is good.

The collection is stored in the funds of the National Museum of History of Ukraine, Kyiv.

Stage CI. Dobrovody (Cherkasy region, Uman district).

The work used ceramics obtained during the excavations of the settlement by an expedition led by Shmagliv M. M. in 1971 and 1974, and expeditions led by Movsha T. G. in 1981-1982. 108 utensils were involved in the analysis. The condition of the material is satisfactory.

The collection is stored in the funds of the Cherkasy Museum of Local History and the funds of the Institute of Archeology of the National Academy of Sciences of Ukraine, Kyiv.

Stage CI. Chicherkozivka (Cherkasy region, Zvenigorod district).

The work uses ceramics obtained during excavations of the settlement in 1984 by an expedition led by Kruts V. O. 97 units of utensils were involved in the analysis. The condition of the material is satisfactory.

The collection is stored at the Institute of Archeology of the National Academy of Sciences of Ukraine, Kyiv.

Stage CI. Talne II. (Talniv district, Cherkasy region).

The work uses ceramics obtained during excavations of the settlement in 1990 by an expedition led by Kruts V. O. 65 units of utensils were involved in the analysis. The state of preservation of the material is satisfactory. Many vessels are highly fragmented and have a damaged ornament.

The collection is stored in the funds of the Institute of Archeology of the National Academy of Sciences of Ukraine, Kyiv.

Stage CI. Talianki (Cherkasy region, Talniv district).

The work uses ceramics obtained during the study of the settlement by expeditions led by Kruts V. O. in 1981-1992. 833 vessels were involved in the analysis.

- From dwelling 1 we have 13 vessels; from the dwelling 2-45 vessels;
- from the dwelling of 3-18 vessels; from the dwelling of 4-12 vessels;
- from the dwelling 5-24 vessels; from the dwelling of 6-16 vessels;
- from the dwelling 7-54 vessels; from the dwelling 8-83 vessels;
- from the dwelling of 9-50 vessels; from the dwelling 10-23 vessels;
- from the dwelling 14-31 vessel; from the dwelling of 15-25 vessels;
- from the dwelling of 16-14 vessels; from the dwelling 17-54 vessels;
- from the dwelling of 18-45 vessels; from the dwelling of 19-60 vessels;
- from the dwelling 20 - 49 vessels; from the dwelling 21-54 vessels.

The state of preservation of the material is good.

The collection is stored in the funds of the Museum of Local History in Cherkasy, the Museum of Bread, Talne, the Institute of Archeology of the National Academy of Sciences of Ukraine, Kyiv.

Stage CI. Maidanetske (Cherkasy region, Talniv district).

The work uses ceramics obtained during the study of the settlement by expeditions led by Shmagli M. M. in 1971, 1973-1976, 1979-1980, 1984-1990. 1259 vessels were involved in the analysis.

18 vessels were taken from dwelling B;	from the M complex - 18 vessels;
from dwelling E - 64 vessels;	from the complex Л - 105 vessels;
dwelling 1 of the complex Ж - 8 vessels;	from complex Ё - 6 vessels;
from the dwelling 2 of the complex Ж-47 vessels;	from the complex Ц - 20 vessels;
from the dwelling 3 of the complex Ж - 98 vessels;	from the complex Ш - 39 vessels;
from dwelling 4 of complex Ж - 58 vessels;	from the complex Ю - 24 vessels;
from the complex 1-K - 54 vessels;	from dwelling I - 48 vessels;
from the complex O - 22 vessels;	from dwelling 3 - 18 vessels.
from the complex Ф - 21 vessels;	
from complex X - 8 vessels;	
from complex 4 - 6 vessels;	
from the complex Ш - 33 vessels;	
from the complex Я - 65 vessels;	
from the dwelling 2 - 40 vessels;	

The condition of the material is satisfactory, many dishes are highly fragmented or have a very damaged ornament.

The collection is stored in the funds of the Institute of Archeology of the National Academy of Sciences of Ukraine and the Museum of Local History in Cherkasy.

Stage CI. Tomashivka (Cherkasy region, Uman district).

The work uses pottery from the excavations of the settlement by an expedition led by Kurinny P. P. 227 units of utensils were involved in the analysis. The condition of the ceramics is satisfactory.

The collection is stored in the funds of the National Museum of History of Ukraine, Kyiv.

Stage CI. Valea Lupului II (Republic of Romania, Iasi County).

The work uses utensils published by Dinu (Dinu M.,1957). 30 vessels were involved in the analysis.

Stage yi. Varvarivka XV (Floresti district, Republic of Moldova).

The work uses ceramics obtained during the excavations of the settlement by an expedition led by Markevich V. I. in 1969. The analysis involved 165 vessels originating from one excavated dwelling. The condition of the material is satisfactory. Many utensils are highly fragmented.

The collection is stored in the funds of the Museum of Archeology and Ethnography of the Republic of Moldova, Chisinau.

Stage yi. Bădragii Vechi (Edinet district, Republic of Moldova).

The work used utensils obtained during excavations of the settlement in 1975 and 1978 by expeditions led by Markevich V. I. A total of 218 vessels were involved in the analysis. From dwelling 1 we have 119 vessels. The condition of the material is good.

The collection is stored in the funds of the Museum of Archeology and Ethnography of the Republic of Moldova, Chisinau.

Hancăuți I (Edinet district, Republic of Moldova).

The work uses ceramics obtained during excavations of the settlement in 1985 and 1986 by expeditions led by Markevich V. I. 152 vessels were involved in the analysis. The condition of the material is good.

The collection is stored in the funds of the Museum of Archeology and Ethnography of the Republic of Moldova, Chisinau.

Stage CI. Konovka (Chernivtsi region, Kelmenets district).

The work uses ceramics obtained during excavations of the settlement in 1975 by an expedition led by Shmagli M. M. 81 vessels were involved in the analysis. From dwelling 1 we have 22 vessels; dwelling 2-59 vessels.

The condition of the material is satisfactory. Many vessels are highly fragmented.

The collection is stored in the funds of the Institute of Archeology of the National Academy of Sciences of Ukraine, Kyiv.

Stage CI. Koshylivtsi Oboz (Ternopil region, Zalishchyk district).

The analysis involved 79 vessels from those published by Hadaczek (Hadaczek K.,1914).

Stage yi. Târgu Ocna-Podey (Republic of Romania, Bacau County).

The analysis involved 89 items of utensils published by Matasha (Matasa K.,1964).

Stage CII. Zhvanets (Khmelnysky region, Kamyanets-Podilsky district).

The work uses ceramics obtained during excavations of the settlement in 1961-1962, 1967-1970, 1973-1974, 1976, 1978 by expeditions led by Movsha T. G. 519 utensils were involved in the analysis. The condition of the material is satisfactory. Many dishes are highly fragmented.

The collection is stored in the funds of the National Museum of History of Ukraine, Kyiv.

Stage yII. Ofatiŋi (Rybnytsia district, Republic of Moldova).

The analysis involved 75 vessels published by Dergachev (Dergachev V. A., 1978), Manzura and Subotin (Manzura I. V., Subotin A. V., 1989).

Stage CII. Usatove (Odessa region, Bilyaevsky district).

The analysis involved 27 units of utensils published by Dergachev and Manzura (Dergachev V. A., Manzura I. V., 1991).

Stage CII. Majaky (Odessa region, Bilyaevsky district).

The analysis involved 10 vessels published by Petrenko (Petrenko V. G., 1989).

Stage CII. Burial mounds of the Usatove type.

The analysis involved 35 vessels published by Dergachev and Manzura (Dergachev V. A., Manzura I. V., 1991) and Yarova (Yarova E. V., 1990).

Stage CII. Zhvanets (Gordinești layer).

The work uses pottery from the excavations of the settlement by expeditions led by Movsha T. G. 15 vessels were involved in the analysis. The condition of the material is satisfactory. The dishes are highly fragmented.

The collection is stored in the funds of the National Museum of History of Ukraine, Kyiv.

Stage CII. Stina I (Gordinești layer).

The work uses pottery from the excavations of the settlement by expeditions led by Makarevich M. L. in 1958-1959. 17 vessels were involved in the analysis. The condition of the material is satisfactory.

The dishes are highly fragmented.

The collection is stored in the funds of the Institute of Archeology of the National Academy of Sciences of Ukraine, Kyiv.

A total of 7917 units of painted utensils were analyzed in the work.

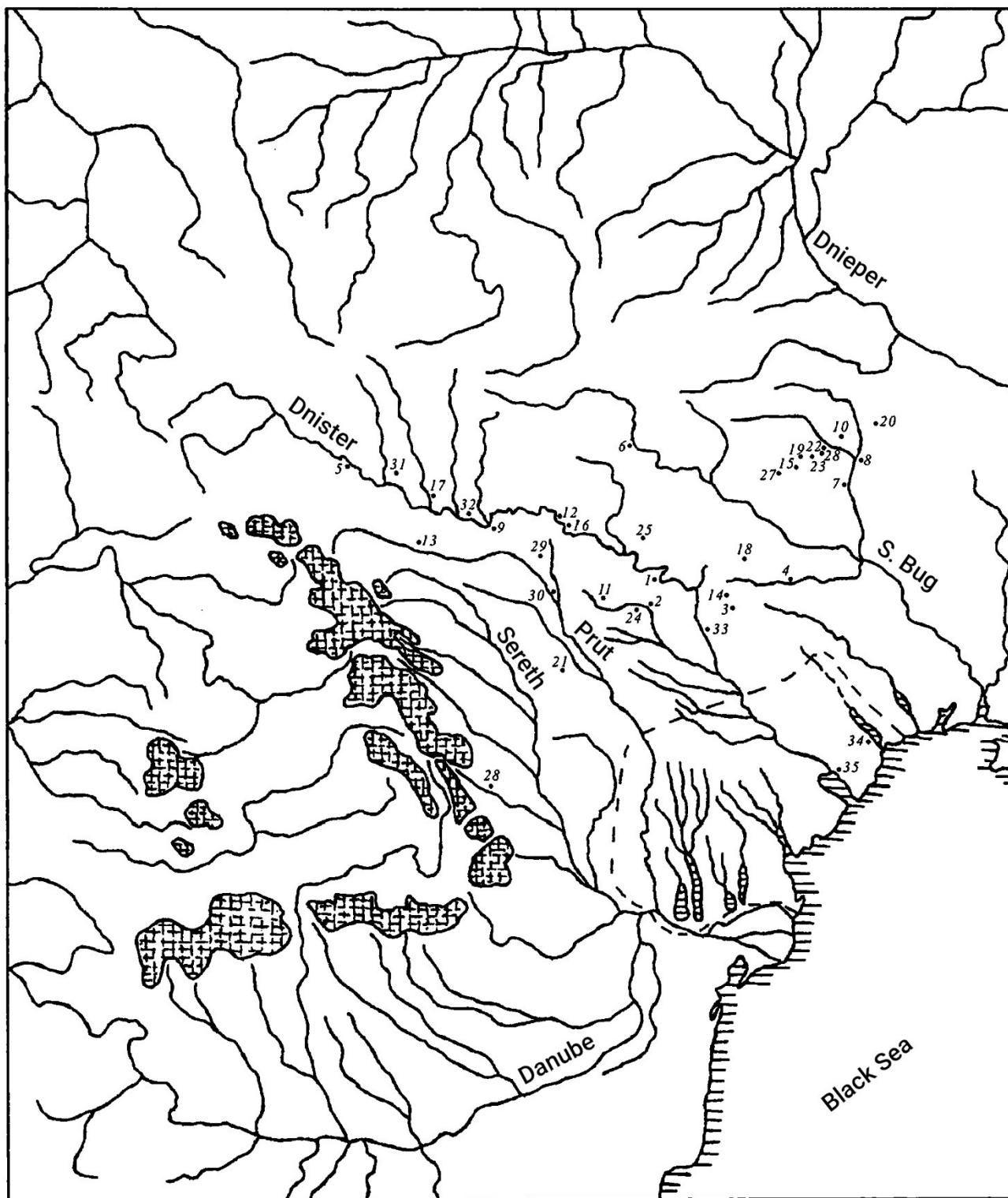

Figure 1: Location of Trypillia monuments, the materials of which were used in the work area of distribution of burials of Usatove type

1. Rakovets. 2. Florești V. 3. Stanislavka. 4. Nemyrivske. 5. Nezvysko III. 6. Voroshilivka. 7. Volodymyrivka.
8. Pischana. 9. Konovka: 1 and 2. 10. Kolodyste. 11. Petreny. 12. Bernashivka. 13. Shipintsi B. 14. Cherkasiv Sad II. 15. Sushkivka. 16. Lipchany. 17. Bilche Zolote Park III and Verteba I. 18. Chechelnyk. 19. Dobrovody. 20. Chicherkozivka. 21. Valea Lupului II. 22. Talne II. 23. Talianki. 24. Varvarivka XV. 25. Stina IV and Stina I. 26. Maidanetske. 27. Tomashivka. 28. Târgu-Ocna Podei. 29. Hancăuți I. 30. Bădragii Vechi.
31. Koshylivtsi Oboz. 32. Zhvanets. 33. Ofatinți. 34. Usatove. 35. Majaky

RESEARCH METHODOLOGY

The proposed work is purely empirical, it does not claim to develop theoretical questions of the nature of the signs or any other problems of semiotics. But before we begin the analysis of sign systems, we consider it necessary to describe the existing methods in semiotics and culturology, on which this work is based.

As is known, the Trypillia-Cucuteni cultural and historical community as a whole belongs to the world of ancient Balkan neo-Neolithic cultures. In these, researchers note a high level of significance for that era. Moreover, as Toporov notes, "the main thing was not extensive, but intensive development, in which the principle itself was much ahead of the symbolic assimilation of empiricism" (quoted by Tsivyan T. V., 1990., p. 89). It is with this that Toporov connects various phenomena such as recoding, bold switching, jumps, and the creation of models from symbolic to objective. This was, as research shows, a very peculiar design of the opposition (what is designated/what is meant), the creation of a network of identities, relationships, transformations. For ancient Balkan neo-Neolithic cultures, signs of the "symbol" type played an exceptional role, and this, according to Toporov, testifies to the actualization of the most profound and intense "spiritual" meanings. To prove this, Toporov cites the use of "pre-written" signs on sacred objects, utensils, sculptures, in contrast to civilizations that used writing for purely utilitarian purposes.

The discovery of the "symbolic" as a special sphere of existence and the amazing penetration into the sphere of the symbolic is connected with the enormous depth of religious actions, their intensity, and scale (Tsivyan T. V., 1990., p. 89). Trypillia-Cucuteni sign systems (as well as others) require new techniques, especially those that develop semiotics as a science of sign systems in nature and society. Semiotics is the most formalized part of systemic-structural research, which, according to Stepanov, brings it closer to philosophy. This quality allows her to most naturally move to philosophy, and especially to the theory of knowledge (Stepanov Y. S., 1971., p. 3-4). This coincides with the general line of development of modern anthropology, which, in the words of Levi-Strauss, "wants to be a semiotic science, resolutely remaining at the level of values. This is one of the reasons (among others) to maintain close contact between anthropology and linguistics, which also stands in relation to the social phenomenon of language, not to separate its objective laws, which created the sound aspect, from the significant functions that create the semantic aspect" (Levi-Strauss K., 1985., p. 323).

In the search for new means of analyzing social phenomena, great progress has been made in linguistics, where they are closest to the level of the exact sciences. These successes are closely connected with the ideas of the Swiss linguist de Saussure. He introduced into science the concept of semiotics as a science for studying the "life of signs within the life of society", in which language is only part of a wider community of semiotic systems. The laws of semiotics, according to F. de Saussure, shed light "on the problems of linguistics, but considering rites, customs, etc., as signs, all these phenomena also appear in a new light, so there is a need to "unite" them all within semiology and explain them by the laws of this science" (Saussure F. de., 1977., p. 54-55). An approach to non-linguistic phenomena of life (rites, customs, etc.) also existed before de Saussure. Thus, the understanding of social life as the functioning of sign systems is inherent to the ideas of the founder of pragmatism in philosophy (which is sometimes considered the founder of semiotics) Pierce (Girenko N. M., 1986., p. 7-9). For Pierce, the class of phenomena "signs" is extremely wide, which includes "pictures, symptoms, words, sentences, books, libraries, words of the order, legislative decrees, concerts. Simply put, everything which is adapted for the mental transmission of impressions which are radiated from something external in relation to themselves" (quoted in Parmentier R., 1990., -p. 26).

This understanding of the sign coincides with the point of view of Husserl E., according to whom each expression is a sign (quoted in Reformatskij A. A., 1987., p. 27). For us, this definition of a sign is very important, because, referring to the ornament of painted utensils as an object of semiotic research, it is important to define, assign and structure such concepts. Therefore, we will dwell on the definition of the sign of E. Husserl. In our case, each graphic (and plastic) expression is perceived as a sign and is subject to analysis. The concept of "sign" neglects the more precise definition proposed by linguistics. According to Reformatskij, it is reduced to 5 points:

1. The sign must be accessible to sensory perception;
2. The sign itself does not matter, but is aimed at the meaning in the intention;
3. The content of the mark does not coincide with its material characteristics;
4. The content of the mark is determined by its analytically distinguished features;
5. A sign and its content are determined by the place and role of a certain sign in a certain system of signs. (Reformatskij A. A., 1987., p. 29).

The semiotic approach is based on three levels of research, which Morris designated as follows: syntactic - which studies the relationship between signs; semantics – which studies the relationship between signs and objects that they mean; pragmatics – which study the relationship between signs and people who use them (Morris C. U., 1983., p. 42). Syntax, according to Morris, deals with two classes of rules: the rules of formation, which determine the permissible independent combinations (blocks), and the rules of transformation, which determine the signs to be obtained from other blocks. Syntactics, thus, studies signs and their combinations, organized according to syntactic rules (Morris C. U., 1983., p. 49).

It is to define the system of organizations aimed at two relations to the sign, identified by R. Bart, - paradigmatic and syntagmatic. Paradigmatic relations offer for each sign a certain set of forms, from which the sign differs due to a certain, sometimes minimal, difference. These differences are sufficient for the implementation and change of content (Bart R., 1989., p. 246). Paradigmatic awareness of signs, says R. Bart, arises as soon as we compare the forms of the two signs or at least look at them in comparison (ibid. p. 247). It is a formal awareness and sees what it means as if in a profile, sees its connections with other signs. It does not see the sign in its deep dimension (as in the case of symbolic awareness) but merely in perspective. That is why, Bart points out, the dynamics of such a vision is the dynamics of the "request". The sign is requested from some closed ordered set, and this request is the highest act of endowment with content. To create content, a person only has to choose from some ready set of elements. They are always structured or their consciousness (according to the binary hypothesis), or simply due to materially complete forms (Bart R., 1989., p. 251).

Determining the paradigm of signs in the case of ornamentation is possible due to the presence of a series of one-type utensils. This allows you to select a constant for the whole series of graphic elements that make up a certain composition - an ornamental scheme. In the fields formed by the schemes of painting, elements are observed, which quite often, in the process of addressing to new units of ware of a certain type, change over other schedule signs. The fields where the small, frequently changing elements have a constant location, can be defined as the locations of the characters. It is these locations of elements on the painting scheme that are the criteria for determining the paradigm of the signs assigned to it. A certain scheme of painting, thus, not only structures small elements (signs) but also limits their number in a paradigmatic series.

Locations of small elements also have certain characteristics. First of all, they are located in the central parts of the compositions formed by the permanent elements of the painting (ovals, metopes, festoons,

etc.). Also, they are often on the handles of dishes, around them, or next to various adhesives. In these cases, it is observed as what Bakhtin defined the interest of culture to the places occurring in a location (Bakhtin M. M., 1990. p., 350-352). It should be noted that the use of signs is not the same. Signs differ not only in shape but also in quantity. Therefore, in addition to studying the location of signs, i.e. their positional analysis, it is important to have quantitative indicators for each sign included in the paradigm. The obtained statistical and positional indicators allow us to understand the functioning of the sign system of each settlement. The syntagmatic imagination no longer sees or almost sees the sign in its perspective, but it sees its development - previous connections or bridges, which are built over to other signs. This consciousness, says Bart, evokes the image of a chain or web, the dynamics of its image suggests the connection of interchangeable moving parts, their combination just produces meaning (Bart R., 1989., p. 251).

Syntagmatic studies of signs, thus, suggest that the sign goes beyond the paradigmatic series, where they cease to play a role, and the effect of observations on the installation of signs, so you can get a picture of their formation. Specific paradigmatic and syntagmatic series selected with the help of statistical-positional analysis can be studied according to the stages proposed by Starikov, which will allow determining their system (Starikov V. S., 1982., p. 100-108). Although they were used to study writing, they can, with some changes, explore complex sign systems, which, of course, include Trypillia-Cucuteni ornaments. These stages (with some changes) are as follows:

1. The direction of the series of signs and their length;
2. The composition of series and types of graphic complexes;
3. The composition of graphic complexes;
4. Signs-blocks and the order of graphs in them;
5. The structure of the signs-blocks and features of their application;
6. The presence of signs in the signs-blocks and the combination of signs;
7. Configurations of signs and principles of change of their sizes;
8. Unusual order of signs in blocks-signs;
9. Constituent elements of the mark;
10. Characteristics of the sign;
11. Characteristics of variations or variants of signs;
12. The number of basic signs and their composition in the schemes of painting;
13. Absolute and relative frequency of use of signs;
14. Permanent, variable, and semi-variable signs in the composition of block signs;
15. Stable combinations of signs-blocks.

The described research methods coincide with what Bart called “structuralism as an activity”, i.e. an ordered sequence of a certain number of mental operations (Bart R., 1989., p. 254). The term “structure” is considered old and its use cannot serve as a distinguishing feature - except in controversy over its content. Instead, Bart proposes to turn to the pairs “what means” - “what they mean” and synchrony and diachrony to get closer to understanding the signs of structuralism (ibid. p. 253). The purpose of each structural-semiotic activity is to reproduce the object in such a way that in such reconstruction the rules of functioning of this object are manifested (ibid. p. 255). After defining the term “structure”, we return to the problem of the practical application of the ideas above. The structural-semiotic activity includes two specific operations - *dismemberment* and *installation*. To dissect an object means to find moving fragments in it, the relative position of which offers additional meaning (Bart R., 1989. p. 257). This includes the above-mentioned selection of general schemes of painting and small signs. Therefore, we repeat the above and expand it in the light of the ideas of structuralist activity. The definition of general painting schemes, which are a kind of meta-signs that unite small moving elements into systems, as well as the already described definitions of paradigmatic and syntagmatic series of these moving signs, belong to the operation of dismemberment.

The very definition of general schemes of painting (meta-signs) consists of several stages. At the first stage through a typological method, the analyzed ceramic complexes decompose on types of ware. It is desirable that the series of the same type of dishes were as large as possible. The larger sample size provides more complete information about the studied objects (in case of this work – the painting schemes and their moving elements). At this stage (as in others as well) the study of the sign system plays an important role in the principle of “the more, the better”: the larger the series of dishes, the more documented conclusions, and assumptions. At the second stage, using the statistical method determines the number of applications of certain general schemes of painting (meta-signs) in their relation to the forms of utensils and small moving signs. These signs, their characteristics, paradigmatic and syntagmatic series are the main object of research in the third stage of the study. The perception of projection on the dishes is important for understanding the general schemes of paintings.

In the archaeological literature, Trypillia-Cucuteni dishes are usually served from a side projection, although from time to time there is a reference to the vertical projection. The most consistent and detailed vertical projection was used in the publication of utensils from the early Trypillia settlements of Tymkovo, Slobodka, and Oleksandrivka. Researchers, referring to it, noted certain conventionality obtained in vertical projections of circular scans, because the observation of the whole ornamental scheme in the plan is often impossible. But there is every reason to believe that, painting the dishes, the masters imagined a scheme of his painting, close to that obtained by the upper projection of the dishes (Burdo N. D., Videyko M. Y., 1984., p. 98). Circular scanning allows you to best understand the location of small elements (signs) in the systems of general schemes of painting, which in the usual “lateral” projection have a completely different look. Thus, “dismemberment operations are carried out to the initial fragmented state of the model, while structural units are not in chaotic disorder, even before their distribution and inclusion in the continuum composition. Each such unit is part of a set of similar units forming a meaningful whole, subject to the highest moving principle” (Bart R., 1989., p. 257-258).

Having identified the units, the structural person (in the words of R. Bart) must identify and fix the rules of mutual connection, from this moment the activity of dismemberment is replaced by the activity of mounting. All products created by structural design are subject to some regular restrictions. In the

second stage of modeling, according to R. Barthes, begins a kind of struggle against chance. The restriction criteria, R. Barthes notes, acquire an almost demiurgic role due to the same units and their combinations, which are repeated regularly. The work becomes a complete whole, in other words, a whole, endowed with meaning, linguists call these combinatorial rules forms. The form, therefore, is that which allows the relationship of contiguity between units not to be the result of chance (ibid., P. 253).

The model constructed in this way returns to us the object no longer in the form in which we first received it, and this is what Barthes sees as the importance of structuralism. Structuralism creates a new category of object, which belongs to the field of functional, and thus fits into a range of scientific research developed by computer science (ibid. p. 259). For the archaeologist (as well as for the anthropologist), who deal with sign systems to written societies, it is the syntactic level of research is the most significant, because, having a well-studied syntactic relationship of signs of certain systems, you can make a variety of developments - from chronological to pragmatic - with varying degrees of probability. Thus, syntactic - is the basis without which other analytical work becomes extremely difficult.

The next part of semiotic research is semantics. It studies the relationship between signs and objects that they mean (Stepanov Y. S., 1971., p. 80). Syntactics is closely related to semantics. As noted by Peltz, syntactic categories are nothing more than semantic categories (Peltz J., 1983. p. 145). This remark allows us to consider the received paradigmatic and syntagmatic series as semantic and to begin research of semantic fields of signs. "Establishing a minimum group of signs that" hold "the whole set of signs is the ultimate goal of semantics" (quoted by Vezhbytska A., 1983., p. 232). One of the steps to identify such basic elements of the sign system may be a diachronic analysis of sign systems and culture codes. The latter, the brightest, include anthropomorphic, lunar, plant, zoomorphic codes, their consideration together with the signs included in them, will obtain semantic contexts for a large number of symbolic signs, as well as elements - semantic markers (according to Manfred Bierwisch). Obtaining the basic elements of sign systems will, in turn, approach the world of cultural values. To do this, refer to the typology of signs. Peirce identified three main types of signs: the iconic sign, the sign-symbol, and the sign-index (Peirce R., 1990., p. 30-31). Iconic copy marks are formed in culture by more or less accurate copying of real objects or phenomena; index signs associated with these items as actions with their causes; signs-symbols are not like those objects or phenomena that they signify, they are used to represent a certain, often abstract concept.

Peirce imagined the triad "iconic sign - index - symbol" in the form of a hierarchical series. Each index to transmit information must cover an iconic sign. As Parmentier notes, the index refers to the mind to a certain aspect of reality, and the iconic sign provides some information about this aspect (Parmentier R., 1990. p. 31). The symbol should also include an iconic sign and an index. The first is to provide information and the second is to point to an object. Each symbol, according to Peirce, contains two infinite series of relations: one - back to the object, the other - forward to the interpreter, i.e. to further action or mental interpretation. Thus, Parmentier comments on this opinion of Peirce: there is not only a finite object that could be represented in a particular symbol - there is no representation, but there is no finite interpreter. Here Peirce suggests an important conclusion: the symbol is to some extent alive in the sense that it is an evolving, growing body. "Symbols grow," writes Peirce, "they begin to exist, evolving from other signs, such as iconic or mixed signs, which have the character of iconic symbols." The generated symbol spreads in the world of people. Its value expands as it is used" (quoted in Parmentier R., 1990. p. 35).

When studying the expansion of the use of signs at the synchronous and diachronic levels, it is important to use the methods of comparison and comparison. Reformatskij, describing them, warned that they should be strictly distinguished (Reformatskij A. A., 1987., p. 40). The method of comparison, he notes, is aimed at finding similarities in sign systems, for which differences are separated. His goal is the reconstruction of what *was*, through the representation of what *is*. The comparative method should fundamentally deindividualize the sign systems being studied in search of the reconstruction of protorealities. "The main means by which it (the method) operates, using auxiliary diachrony, -set various sections of synchrony" (Reformatskij A. A., 1987., p. 40). The method of comparison, on the contrary, is based only on synchrony. Only the consistent determination of the contrasts and differences of similarities and *differences* can be the goal of the study of sign systems (ibid., P. 41). Turning to the analysis of specific propositions, it should be kept in mind, that any image is polysemantic. As Barth noted, under the layer of the signifier lies the floating chain of the signified. Polysemy makes you ask questions about the content of the image. This question always remains a manifestation of dysfunction, which causes uncertainty of the content. That is why each society produces various technical means aimed at stopping the floating chain of the denoted and designed to overcome this uncertainty (Bart R., 1989., p. 304-305).

Ideology is the means of how a culture struggles with the polysemy of images. Greimas and Courtés approached this in terms of semiotics, recognizing the broad semantic field covered by the concept of "ideology", and the many misunderstandings that arise through the ability to differently interpret and define this concept. They distinguish between two fundamental forms of organization of the world of values: their paradigmatic and syntagmatic division. In the first case, values are organized into systems, which Greimas and Courtés call "axiology"; in the second case, the means of organizing values is syntactic, and values act as a part of models that are potential possibilities of semiotic processes. Values included in certain axiology arise as a result of the semiotic division of the collective semiotic world, thus they belong to the level of deep semiotic structures. As part of an ideological model, they are adopted by the subject, individual or collective, who commits the act of expression. Thus, ideology actualizes the values that it chooses within axiological systems. Ideology is a constant search for values, and the structure that carries information about them should be considered as repeated in every ideological statement (Greimas A. J., Courtés J., 1983., p. 496). Ideological expression at any moment can acquire a greater or lesser degree and thus become a mythological expression (ibid. p. 496). Questions of value theory and ideology belong to the third stage of semiotic research - pragmatics. According to Morris, pragmatics studies the origin, application, and influence of signs (Morris C. W., 1983., p. 130). The use of signs means operating with something like a sign, within the signing process. Morris identifies four main cases of use of signs, calling them informative, evaluative, coercive, and systemic. Signs can be used to inform someone about the properties of objects or situations, to force someone to behave concerning certain objects or situations, to cause a certain line of behavior that is already caused by other signs (Morris C. W., 1983., p. 131).

Recently, there has been increasing interest in the role of signs at the stage of manipulation and completion of actions. To these phenomena, Morris attributed ritual, myths, morality, art, laws, politics, religion. And since each of these areas offers the concept of value, he pays special attention to the theory of values (axiology), the study of the relationship between signs and values, the place of values of human activity, i.e. ideology (ibid. p. 131). The ideology of Trypillia-Cucuteni societies is now defined as predominantly agricultural. As shown in the first chapter of our work, the phenomena of ornamentation

are considered as its derivatives. That is, the agricultural way of farming determines the appearance of symbols that are closely related to it. Such a fulcrum is certainly correct, but not absolute. In addition to the direct economic determination of the phenomena of ideology, other factors are no less significant influence on the creation of signs and their functions. One of them is ritual. Researcher of this phenomenon Evzlin cites the observations of Evans-Pritchard about the attitude of archaic man to "natural phenomena" and the influence of the latter on mythos-ritual constructions. They show that "primitive peoples show very little interest in natural phenomena that may seem the most impressive" (quoted by Evzlin, M., 1993., p. 171). Based on this observation, Evzlin concluded that the idea of regularity, the recurrence of the natural process for ancient people was not a direct fact, but arose as a result of a long development, the main factor of which was the ritual (ibid. p. 171).

He reconstructs the scheme of the ritual as follows:

- 1) Something disappears;
- 2) Due to this disappearance - the life cycle is stopping;
- 3) Return - renewal of the life cycle (Evzlin M., 1993. p. 120).

The ritual scheme, according to Evzlin, determines the perception, for example of changes in seasons, and vice versa. The ritual scheme suggests the presence of a cause. It "overlaps" with natural phenomena, models them, makes clear the relationship between cause and effect. Ritual, says the researcher, can be considered the first "mathematical model" of reality. Yes, Campbell wrote: "Rituals are a cosmogonic principle, like formulas in modern physics. Through them, the operational modalities of the mysterious cosmic forces not only become accessible to the human mind but also controllable" (quoted by Evzlin M., 1993., p. 121). Thus, the natural arrangement of things is not perceived as a sign. Something becomes "significant" when it is located in the second "emergency" order, and therefore is interpreted not a change of seasons, but as a ritual scheme, which is first implemented in a sequence of "unusual" movements (or images of signs). Due to this it becomes significant and further generates meaning. Equally important for solving the question of the origin and use of ornament and "universal symbols" is, on the one hand, the testimony of anthropologists who lived for some time among the natives of Central and South America, and on the other hand -the results obtained in studies of the human subconscious. Researchers who have long lived among the Indians of South America, report that under the influence of psychotropic substances used during the ritual, they saw ornaments similar to those depicted on the dishes. These visions had their system, their rhythm.

Here is how the American anthropologist Michelle Harner describes it: "When I went to bed, on this night of arrival, in the darkness of the house, paintings of brilliant and reddish hues appeared. What I saw was very strange, the curvilinear patterns intertwined, diverged, and circled in a very pleasant way. Then, among the changing patterns, small demonic faces appeared, circling, disappearing, and reappearing. I felt as if I saw spirits living in Makass." (Harner J. Michel., 1991., p. 24). It depicts beautiful patterns, almost like the ones I saw last night" (ibid., P. 25).

Here are the results of the American psychiatrist Stanislav Grof during studies of the effects of the psychotropic substance LSD on the human subconscious: "Visualization of various universal symbols is an important part of LSD sessions," he said. "Many people undergoing LSD treatment had visions of complex geometric compositions that resembled oriental mandalas" (Grof S., 1994. p. 223-224). The symbols of the cross, the six-pointed star, the swastika, the Egyptian hieroglyph "ankh" ("life"), the lotus

flower, the Laotian yin-yang, the Buddhist Wheel of Samsara, the circle (ibid. p. 224) were most often observed in the sessions. Of the universal symbols listed by S. Grof, all graphic equivalents of these signs can be seen on the Trypillia-Cucuteni ornaments, they are here general schemes of painting (meta-signs) and are visible in the vertical projection on the dishes.

One of the most important questions of pragmatics is: were the ornaments of the Eneolithic perceived by the population of that time assigns? After all, according to Pierce, something is a sign only because it is interpreted as a sign of something by a certain interpreter (Morris C. W., 1983., p. 40). The same applies to the term "sign": the sign is expressive to the extent that its formation or the production itself is perceived by the interpreter as a sign of a certain state of the one who created it" (Morris C. W., 1983 p. 126). These questions can be answered by a diachronic analysis of signs and taking into account their contexts, which will allow obtaining those sign expressions and means of their organizations, which have been transmitted in culture for a long time and which are evidence of interest in certain signs and ability to operate. This allows us to perceive the ornament of utensils as sign systems, hierarchically organized, which in general looks like this: the forms of utensils - schemes of painting - small elements of painting. According to the German researcher of aesthetics Wilhelm Worringer, who studied the spiritual conditions that direct, in his terminology, "artistic will" to either naturalism or naturalism.

Naturalism, according to W. Worringer, is always the product of cultures in which a harmonious balance between man and space has been achieved. The man within this type of culture feels part of nature. The world of nature does not cause fear; it has what Worringer called the relationship of trust and approach to the world, as a result, it creates a naturalistic art that joyfully repeats the forms and phenomena of the objective world. On the other hand, as the relationship between man and space becomes disharmonious and unbalanced, linear-geometric styles emerge. For primitive peoples, the outside world is unknown chaos, a mixture of events and feelings that cause fear. Naturally, at this stage of cultural development, they do not feel any satisfaction from the objective image of the world. The world of everyday experience in such an era - is a world of fear, and depicting it would only intensify fear. Therefore, at this time turn to the direction opposite to naturalism. "Artistic will" reduces the phenomena of the natural world to linear-geometric abstract forms that have stability, order, and harmony (Frank D., 1987., p. 208-209).

Of course, says D. Frank, referring to this division of cultural phenomena, it should be borne in mind that we are talking only about the theoretical boundaries of two categories of styles, to which, according to Worringer, cultures approach only to a greater or lesser extent. Elements of both styles can be found in all historical periods, so the culture is said to create one or another style in the dominant, and not in absolute exclusivity (ibid. p. 210). Also, in the case of appeal to the Trypillia-Cucuteni ornaments with a dominant linear-geometric style, there are elements of the "realistic", or rather "conditionally realistic". They, as a rule, belong to the signs-icons.

Considering the phenomena of sign formation of the Eneolithic in the light of the ideas of Worringer, we can perceive them as the struggle of the people of that time with the chaos of the environment. Drawing certain geometric signs that correspond to a certain rhythm and patterns, people seemed to re-create the world, bringing it order and stability. On the other hand, this understanding of ornamentation allows us to approach the process of signification as certain ritual actions and perceive the elements of ornament as ritual signs aimed at reducing or eliminating conflicts and stressful situations in which societies often found themselves (Turner V., 1983., p. 112).

Another important issue of pragmatics is the semiotic characterization of the cultural space occupied by the Trypillia-Cucuteni community. As is known, the cultural space is not homogeneous, it consists of nuclear structures (often several) and the periphery (Lotman Y. M., 1992., p. 16-17). Therefore, it is very interesting on the example of Trypillia-Cucuteni sign systems to consider how these two levels of culture interact. It is noticed that on peripheral sites that are less organized and have flexible designs, dynamic processes of development of sign systems meet less resistance and develop faster (ibid. p. 16). How this happened in each case at the stages of development of the Trypillia-Cucuteni community will allow us to understand the specific analysis of synchronous settlements of different local groups. Summing up the section, we note that pragmatics is the most complex and hypothetical part of semiotic analysis. But this should not be feared, because, according to the Austrian logician Wittgenstein, "every explanation is a hypothesis." This applies even to seemingly fundamentally reasoned constructions.

SYNTACTICS AND SEMANTICS OF BASIC SEMANTIC MARKERS

The view of Pierce and Morris that a sign is the first element of sign systems is important for our research. Since we share these views, the following sections begin an analysis of the main graphs.

Based on diachronic observations of sign compounds, it can be assumed that the sign systems of Trypillia-Cucuteni culture were based on a small number of simple key signs. For the first time, they appear in full on the painted dishes of the Rakovets group and later form the basis on which the creation of new images was continued, which in most cases have the form of associations of simple graphs with each other. These simple basic graphs include images of black, rarely red circles; curbs in the form of strips filled with horizontal lines; lenticular black or red vertical ovals or less often horizontal lenticular ovals and their equivalents; wavy ribbons; circles with crosses inside; moon-shaped figures; vertical groups of small horizontally located lines. Besides, we can assume the existence of a few simple signs, which are available for analysis of the material occurred only in blocks - polygrams. These images can be found in the form of medallions with semicircles inside; vertical single lines (or groups of vertical lines); groups of inclined quadrilaterals; vertical strips flanked by vertical hemispheres.

Thus, since the existence of the Rakovets group, we can confidently identify 7 simple characters that can no longer be divided into smaller components. Besides, five simple signs can be assumed to exist. Such signs do exist in the later sign systems of the BI stage; perhaps, if the authors could get acquainted with the lid material from the settlements of the Rakovets group, they could be found here. Consequently, 12 basic signs – graphemes can be defined. The dynamics of their application will be shown in detail in the section devoted to the study of pragmatic relations. Somewhat ahead of pragmatic research, we note that these signs are semantic markers, the dynamics of their applications determines the dynamics of the development of sign systems of the Trypillia-Cucuteni community as a cultural unity.



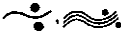

One of the important achievements of the symbolic awareness of the semantic meaning of Trypillia-Cucuteni ornamentation is, in our opinion, the correct definition of grapheme signs in their relationship with creatures, objects, and phenomena of the environment. Thus, a wavy line or ribbon is defined as a sign of a snake (Bobrinsky A. A., 1902) or water (Krichevsky E. Y., 1949; Rybakov B. A., 1965), a segment - as a sign of the moon (Bolsunovsky K. V., 1908; Pybakov B. A., 1965). In addition to these two iconic signs, we consider four other symbolic signs to be correctly interpreted. These are vertical rows of lines and sloping lines - signs of water and rain (Rybakov B. A., 1965); lenticular ovals - signs of grain (Videyko M. Y., 1989); oval with two hemispheres inside - the sign of the moon (Rybakov B. A., 1965).

In this section, we will focus on the relationship of 12 selected characters with objects and phenomenal environment. To study the syntactic and semantic relations of these graphemes two strategies are chosen. The first is the observation of other signs surrounding the sign under study. That is, by analyzing the context of the sign, its connections with other graphemes are determined, first of all with signs-icons. In other words, we explore the semantic fields of the sign, while paying special attention to the signs-icons.

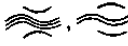



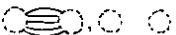

The sign “black (red) circle” ● ○

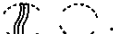



This sign belongs to the simple signs that were most often used in the sign systems of many local groups, starting with Rakovets. On the painted bowls from the settlements of Nemyrivske and Stanislavka, black circles flank the iconic signs in the form of wavy lines: 



This is how water was depicted in many archaic cultures, so this sign can be attributed to the universal ones. On the bowls from the settlements of Rakovets and Florești V in the place of black circles are drawn moon-shaped signs - universal images of the moon:  Also, in the sign systems of settlements of the beginning of stage BI “Crescent of the moon” is assumed to have been depicted.

Among the signs of the settlement of Volodymyrivka signs-symbols in the form of a black circle are depicted next to the images of the crescent of the moon in the painting scheme in the form of an S-shaped arc;  up under the black circle on the handle are depicted on an amphora painted with a “front” painting:  Besides,  black circles are at the ends of wavy lines inside the bowls:  Studies of black circle equivalents indicate that it is sometimes replaced by horizontal lines and black lenticular ovals: 



The semantic field of the sign “black circle” in the sign system of the settlement of Volodymyrivka has the following form: crescent moon (4 graphemes) - water (2 graphemes.) - the crescent of the moon (1 grapheme). In the synchronous Volodymyrivka settlement of Nezvysko III, in its sign system, the black circle was located in small ovals of bowls, painted with the scheme in the form of the number “8.” It is replaced by signs-icons “water” and “moon”: 



The semantic field of the black circle has the form: water - crescent moon. On a vessel from the settlement Kolodyste black circle is combined with a wavy ribbon:  Inverts, painted scheme in the form of arcs, which go one after another, the black circle changes to a lunar sign:  Among the painted utensils from the settlement of Sushkivka, a black circle is on a truncated-conical bowl next to the signs-icons “moon” and signs-symbols in the form of a lenticular oval filled with oblique grid:  Besides, signs in the form of black circles include the montage of the image of some fantastic animal flanked by lenticular ovals:  On the same vessel, near the handle, two black circles are part of the polygram in the form of a moon-shaped scallop with a heel and vertical lines on it. Circles are drawn under the festoon:  Among the signs from the settlement Chicherkozivka is a polygram, which consists of a black circle, combined with drawings of the crescents of the moon and lines that depart from their horns:  Besides, we have an image of a black circle next to the moon sign. The black circle is combined with a vertical dash and all together form a figure resembling the letter “Ю”: 



On the painted ware from Dobrovody on the handles of the ware, there is a replacement of the black circle with the horizontal lines: , lens-like ovoid, also filled with a grid:  In the schemes of painting “front motif”  black circle is replaced by horizontal lines: , horizontal lines in combination







with a moon-shaped negative figure: , wavy lines , black lenticular oval, lenticular oval, located on double lunar signs: 





Observation of contexts and substitutions of a sign in the form of a black circle on a painted vessel of the II phase of the Tomashivka group allows to determine its semantic field as follows: crescent moon (1 grapheme from Sushkivka, 2 - from Chicherkozivka) and animal (1 grapheme from Sushkivka).

On the painted ware of the III phase of the Tomashiv group from the settlement of Talianki, there are already known combinations of a black circle with signs-icons of the moon. In the painting scheme "facial motif" the sign is depicted with two double moon signs: . Another combination of the moon has these signs with black circles on anthropomorphic vessels, where the sign in the form of a horizontal crescent moon with horns up is drawn under a pair of protrusions that mimic the chest. Black circles flange the figure . It should be noted that sometimes black circles are drawn directly on forged in black circles: "chest" protrusions.

Besides, single:  double:  and triple:  black circles were located in the center bowls surrounded by moon-shaped signs that complete the ribbons, which go one after another.

Further, a new icon sign appears around the black circle  - Observations of the replacement of the sign on the bowls in the area of the end of the ribbons, which come one after the other, showed that most often its equivalent here is moon-shaped  and, very rarely, lenticular signs: 

Black circles are replaced by moon signs on the "owl face" in the form of a combination of the sign of the plant with a black circle is replaced by a lunar sign in the second tier of the painting of biconical utensils without handles:  Black circles  in the centers of the bowls are  replaced by images of lenticular ovals:  On the bowls painted with the figure in the form of the number "8", black circles are drawn in small ovals, and in large ovals had wavy ribbons: . Black circles on biconical utensils:  sometimes replaced by horizontal signs in the form of the moon: 

In the sign system of the settlement Maidanetske, along with black circles, there are many signs-icons, which allows the most complete study of its syntactic and semantic relations. Thus, black circles and lenticular ovals flank wavy ribbons in the paintings of bowls: . Black circles were also sewn in the centers of cruciform compositions on bowls. These compositions are created by cross-arranged signs-icons of plants, signs-symbols in the form of dashes:  and wavy ribbons that diverge (or converge) from the central circle:  Another complex polygram is depicted in the center of the bowl. It consists of six black circles (three on each side) flanking a large lenticular oval, inside which are drawn smaller lenticular ovals filled with an oblique grid. From the large oval depart (or enter it) two wavy ribbons:  In another polygram, black circles flank a lenticular oval, drawn on the handle of the vessel, below it are short vertical lines (signs-icons of grass?), And above these signs are three plants:  We also have a polygram in the form of a wave combination lines and plants departing from the black circle:

On bowls, single or paired black circles were drawn next to the signs of the moon:



There was also a grapheme in the form of an arc with two black circles at the ends - the sign of the moon: (?). Such a sign is no longer found in the sign systems of the Tomashivka group, but we have quite a lot of them on the dishes of the settlements of the Petreny group.

Black circles merged with the moon sign into one block. There are two such polygrams: They are drawn on the painting scheme of a biconical vessel and a bowl. Besides, the black circles were drawn

in montages of icons-icons of animals and some fantastic creatures:

In the centers of the bowls the black circle is replaced by two: ••, four: •••• and six: •••••• black circles of two-

black circles united by a ladder sign, in one case, and a ribbon filled with grid: - in another; lenticular

ovals ; oblique cross: ; double lunar crescents: double triangles:

Among the vessels from Talne II there is a biconical vessel painted with a two-tiered "petal" scheme. In the first tier, in the center of the composition, horizontal signs of the moon were depicted with lines departing from the horns:



, and in the second-tier black circles were drawn:

The first sign consists of a black circle on the handle and two lunar signs depicted below it: the second consists of a group of horizontal lines on the handle, black circles flanking it, and a horizontal

lunar sign below it: icons accompanying the black circle , its semantic field in the settlements of phases III and IV of the Tomashivka group can be reconstructed as follows: **crescent moon** (6 graphemes from Taliانki, 8 - from Maidanetske, 3 - from Tomashivka) - **water** (3 graphemes from Taliانki, 7 - from Maidanetske) - **plants** (2 graphemes from Taliانki, 3 - from Maidanetske, 1 - from Tomashivka) - **ladder** (1 grapheme from Maidanetske) - **animal** (1 grapheme from Taliانki, 8 - from Maidanetske).

Black circles in the sign system of the Chechelnyk group were also replaced by signs-icons of water (Cherkasiv Sad II): on the schemes of painting in the form of S-shaped arcs. In the same

diagram, a grapheme in the form of a ladder is once depicted in a black circle next to it. Also, black circles painted on the ends of animal tails:

Black circles also flank a wavy ribbon on the painted utensils of the Stina IV settlement:





On the opened bowl with the scheme in the form of the number "8" they change to lunar signs of this, wavy ribbons are combined with black circles on the scheme of painting "owl face":





Black circles were used in the sign systems of the Petreny group **water - moon - ladder - animal**. On the painted utensils from Petreny settlement, they flank the wavy ribbon of the bowl painting:

besides, they end with the wavy ribbons:

Double wave-like figures which are also flanked as follows

Sometimes, as “glasses”, ovals in the middle of red triple-crosses depict black circles . Sometimes they occur on the tops of triangles, which are located between the “faces”: . As you can see, in Petreny paintings next to black circles bright icons were almost not painted, except in the already mentioned case when they flank a wavy line. As for the replacement of this sign with others in a similar context, only on the biconical amphorae painted with the “Tangentenkreisband” scheme, the signs in the form of black circles, which are depicted in ovals, are replaced by several tafems, including one sign-icon “animal”: . A few more signs-icons are depicted next to the black circles in the sign system of the Bernashivka settlement. 

Signs in the form of arcs with black circles at the ends (only 7 copies) are depicted twice next to the signs-icons. Once in the bowl, they flank a wavy line. Somewhat ahead of the analysis of the sign-icon “moon”, we note that it is in these places most often depicted moon signs. This allows you to perceive the described signs as lunar. In the second case, the lunar sign (arc with black circles at the ends) is





drawn next to the sign-icon “snake”: . Black circles were also located in the centers of the bowls. In one case, the sign of the black circle is depicted in the center of the triple cross, which divides the bowl into four parts. In one of them, the moon sign is drawn: 

On the second bowl a straight ribbon filled with dashes passes through its center, it is crossed crosswise by a wavy ribbon. The black circle is in the center of this kind of cross. On its free fields there are three signs-icons in the form of crescents of the moon: In the sign system of the settlement of Lipchany, the sign in the form of an arc with black circles at the ends (the sign of the moon) is depicted on an anthropomorphic vessel in the form of a headless body. It is located in the center of its “belly”.

The analysis of combinations of a sign-symbol with signs-icons allows to receive a semantic field of a black circle in sign systems of the Petreny group: **the crescent moon**, (4 - from Petreny) - **snake** (1 grapheme from Bernashivka) - **ladder** (1 grapheme from Petreny). Observation of other signs that replace this grapheme adds more signs-icons of animals and birds. And the use of a black circle on anthropomorphic vessels shows, which sometimes marked the “eyes” and “belly” of this vessel.

If we compare the semantic fields of the black circle of the Petreny and Tomashivka groups, we can easily see that they have similarities at the level of icon signs, which often occur next to them or are replaced by them in the same contexts (painting schemes). But their comparison allows us to see some differences. Thus, in the Petreny sign system, animal icon signs appeared twice next to circles (although red), while in Tomashivka black circles were often included in the montage of images of animals. Signs-icons “snake” is not typical for the Tomasz group, while in the Petreny sign system there are no signs-icons of “plants”, which are included in the semantic field of the black circle in the Tomashivka sign systems.

In the sign system of the Konovka settlement, black circles were drawn at the ends of some figures (possibly signs-symbols of bucranium):  a drawing with this sign once had drawings of animals,

however, they do not look like Bovidae, but rather like dogs:  black circles combined with wavy ribbons (water icons):  on a biconical  dish and in a bowl: 

On S-shaped arcs, black circles are replaced by images of the double moon in the first quarter: 

On the cut-conical bowls, painted with the scheme in the form of the number “8”, in small ovals, the black circle was sometimes replaced by watermarks.

The semantic field of the sign in the form of a black circle in the sign system of the Konovka settlement, the painted utensils of which have both Petreny and Shipintsi features, has the following form: **water**  (2 graphemes) - **the crescent moon** (1 grapheme) - **animal** (1 grapheme).

In the sign system of the Shipintsi group, black circles were drawn only in the vicinity of icon signs of water: on a biconical amphora and a bowl (Shipintsi B).

On the dishes from Bilche Zolote Park III black circles are drawn on the ends of arcuate figures (signs of the moon): 

In a bowl from the later settlement of Bilche Zolote Verteba I black circles were included in the installation of a cruciform figure in the center of the bowl. It is surrounded by double signs-icons of the moon and animals: 

The amount and inaccessibility of material from the settlements of the Shipintsi subgroup do not allow to understand the semantic field of the black circle in full in this region of the cultural community. One can only notice the already familiar connection of the black circle with the water icons (3 graphemes from Shipintsi B) and the crescent moon (2 graphemes from Bilche Zolote Park III). In very limited material from the later Bilche Zolote Verteba I, the semantic field of the black circle is associated with the crescent of the moon and the animal. (The study of the substitutions of these signs allows us to trace its connection with the images of animals and plants. And the whole series becomes very similar to Tomaszow: **water - the crescent moon - plant-animal**.)

In the paintings of dishes from the settlement of Valea Lupului II, black and red circles in the painting scheme “Tangentenkreisband” were depicted next to the wavy signs-icons “snake - water”, which were located in the tangents. On the anthropomorphic vessel in the form of a body without a head under the protrusions- “chest”, on the abdomen is a red circle in a double black oval.

In the sign systems of settlements of the end of CI-γI black circles are more and more often replaced by red ones. In the sign system of the settlement of Valea Lupului II, this sign was depicted next to the signs- icons “snake-water” and on the “belly” of an anthropomorphic vessel surrounded by the crescents of the moon. The iconic system of the settlement of Bădragii Vechi also includes black circles. They were part

of the mounting image of crosses in small ovals on the bowl: . Black circles are drawn on the ends of the triple cross. The large ovals on this bowl depict water icons in combination with the moon

icons: 

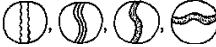
No less interesting is the replacement of the cross in the oval with black circles at the ends and only the water icons:  Red circles in the "Tangentenkreisband" schemes were sometimes drawn

next to signs-icons "snake - water". In this scheme of painting, we have a sign-symbol, similar to that on the bowl: a cross in a medallion (oval) with black circles at the ends. There are double wavy lines - signs-

icons "snake - water":  There are also black circles at the ends of the sloping lines drawn in the second tier of the high-necked tableware. They are depicted in a row with double black wavy lines (signs-

icons of "snake-water"):  . On this type of vessel black circles are drawn in the center of wavy ribbons:

3 the lowest tier of the painting of one such vessel had several signs (each in a separate oval), consisting of red circles, a vertical sign-icon "snake - water" and W sign: 

Hancăuți I sign system is very close to Bădragii. Thus, in the "Tangentenkreisband" painting schemes, the black circle is replaced by medallions with crosses, four black hemispheres, and two wavy lines were depicted in one medallion. Arc-shaped figures with black circles at the ends are depicted along with



circles- "eyes" in the schemes of painting "owl face":  In this vessel, black circles are applied to the

vertices of the triangles between the "faces". Once the black circle is combined with the ladder: 

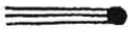

In the sign systems of monuments of the Bădragii type the semantic field of the black (red) circle can be reconstructed as follows: **crescent moon** (2 graphemes from Hancăuți I) - **water snake** (1 grapheme from the Bădragii Vechi) - **water** (1 grapheme from Bădragii Vechi) - a ladder (1 grapheme from Hancăuți I). Observation of sign substitutions adds to this field the icon-signs "animal" and (rarely) "plant", and their location on anthropomorphic "owl faces" is an anthropomorphic code association of the lunar crescent with a black circle. They were interchangeable on the dishes. All this allows us to perceive the black circle as a sign of the full moon.

The probability of such an interpretation is indicated by the drawings on the dishes of the Tomaszow group of large black circles surrounded by the crescents of the moon, so a picture of the full lunar cycle is created (the month in the first quarter - full moon - the month in the last quarter). Six black circles are drawn on another biconical vessel from Talianki. It is interesting that here two black circles are flanked by monthly negative sickles. Similar schemes of painting with black circles, flanked by the moon, also occur on dishes from Maidanetske.

Borders in the form of ribbons filled with horizontal parallel lines

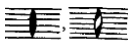

In the settlements of the Rakovets group, the present grapheme occurs quite often. But the available material does not allow to observe the surrounding signs-icons and signs that replace them. Somewhat better conditions for this area in the sign system of the stage of BII settlement Nezvysko III. However, here they are drawn surrounded by symbols. On the bowls, in the schemes of paintings in the form of ribbons, one after the other, they are filled with parallel lines that end in black circles:  as it became known from the previous analysis, the signs of the full moon. Sometimes in the second tier of the painting of amphorae in the borders were depicted vertical lenticular ovals, in two cases with wavy ribbons inside - signs-icons of water: .

This grapheme has similar contexts in the sign system of Volodymyrivka. The border of horizontal parallel lines, except for bowls, was drawn here on cups between metopes, on small amphorae, on large amphorae in the second tier of the painting, on amphorae with a "front" painting.

In the sign system of the settlement Pischana, the studied grapheme was depicted in the same places of similar types of utensils as in Volodymyrivka. Vertical lenticular ovals are depicted in the borders, which were drawn in the second tiers of amphora paintings. One of them has a wavy ribbon inside: , narrow free fields: .

Besides, in the curbs, there are images of vertical lines, which form empty fields. One time, in such a field, is drawn a vertical wavy ribbon (sign-icon of water): . In the sign systems of other settlements at the end of the BII stage, the border of the horizontal lines was depicted in the same contexts as before (the middle of the BII stage), but without images of iconic signs next to them, which could help to study its semantic field.

At the beginning of the CI-yl stage in the sign systems of the Tomashivka, Petreny groups, and the Shipintsi subgroup, the studied grapheme is associated with the signs of water in the form of a crescent moon (or full moon). Sometimes signs-icons of water were painted next to them, and the signs of the moon were replaced by signs in the form of lenticular ovals. Sometimes the lines were drawn inside the sickle. Sometimes the arcs ended in black circles (signs of the full moon). This second variant of ending arcs was used in the bowls of all other local variants of groups, while the first is characteristic only of bowls of the Tomashivka group. ovals.



In Tomashivka sign systems of the II phase of development with the border filled with parallel horizontal lines, certain changes occur. They are increasingly being replaced by other signs-symbols (Chicherkozivka, Dobrovody). This phenomenon continues in phase III. In the paintings of bowls from the settlement of Talianki in ribbons (arcs), along with others, there were signs of water: , ladders:  and arcs which acquire a ladder-like shape .

Once it can be observed among the signs that were drawn in the ribbons of the schemes in the form of arcs, one after the other. It was also painted in metopes on cups. Here they are replaced by iconic signs in the form of animals and ladders.

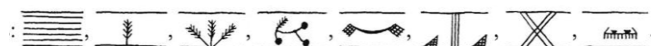

On the second tier of paintings of biconical utensils without handles, the border, which consists of horizontal parallel lines, is replaced by signs-icons in the form of plants, animals, the moon, and signs-symbols: oblique crosses, triangles, and a sign resembling a comb



. Also, there is a polygram, which consists of superimposing the border of horizontal lines on the sign-icon "plants" with white dots at the ends of the



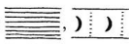

branches: . Another combination of the border with the sign-icon "plant" reconstructions: .



On the paintings of bowls arcs, coming one after another, from the settlement of Tomashivka in ribbons, along with other signs-symbols depicts signs-icons in the form of a crescent moon in the vicinity of the











vertical dashes:  and ladders: .

Analysis of the location of icon signs next to the studied grapheme allows us to outline the semantic field in the sign system of the Tomashivka group. It is very limited and consists only of signs-icons of plants (3 graphemes from Maidanetske). Only observation of the signs that replace it, allows you to add more signs of water, ladders, and the moon. This sign was used only on the monuments of the beginning and middle of the CI-PI stage. It was no longer used on the painted utensils of the Cucuteni and Bădrăgii settlements. It is not present in later paintings of CII-γI.

Lenticular oval

This sign belongs to the most archaic ones. In the sign system of the Rakovets group, it was included in the form of lenticular ovals flanked by black or red circles  (Florești V; Nemyrivske: ). They were painted on the handles inside the medallion with hemispheres (Nemyrivske, Stanislavka): . Also, they were depicted in free fields cross-shaped sign in the medallion on the bowl (Rakovets): .

In the schemes of painting in the form of S-shaped loops of biconical ware from the settlement of Volodymyrivka vertical or slightly inclined black lenticular ovals are applied in their middle or center in the form of interception: . Here it is replaced 4 times by signs-icons "moon" in the first quarter .



In the sign system of Volodymyrivka signs in the form of a lenticular oval are often replaced by black circles in the schemes of painting bowls and utensils: . In this case, many signs are added horizontal lines: , , , . more signs-icons of water: , , ,  and signs-symbols in the form of vertical lines. The sign-icon "water" is included in the polygram in the form of vertical or horizontal lenticular oval: . These polygrams are probably equivalent to black circles because they were applied in the same contexts as the latter. Besides, empty lenticular ovals are drawn here: .



The semantic field of the **lenticular oval** in Volodymyrivka paintings is associated with a **black circle** (a sign of the full moon) (14 graphemes) and **water** (7 graphemes). Observation of sign substitutions adds here the **crescent of the moon** in the first quarter (4 graphemes).



A similar semantic field (but without the sign of the full moon) has a **lenticular oval** in the sign system of the settlement Nezvysko III: **water** (24 graphemes) - **the crescent moon** (1 grapheme).











On the inner side of the crowns of craters from the settlement of Voroshilovka black lenticular ovals were replaced by signs-icons of water: .

The same replacements are observed on craters from the settlement Pishchana: .







In the settlement of Kolodyste on the handle of a biconical vessel, the black lenticular oval is combined with a sign "moon" . Lenticular oval acquires a straight and oblique grid inside, but black and hollow ovals remain next to them. As for the environment of this sign, in one case on the bowl it is depicted next to the signs-icons "moon" and black circles-signs of the full moon: . Otherwise, lenticular ovals flank the image of a fantastic animal: . Black circles - signs of the full moon - are flanked by lenticular

ovals (2 times), and once the sign is flanked by signs resembling a comb: . One sample, it seems, was found with a complex polygram drawn over it (in the second tier): .









On the bowls from Chicherkozivka lenticular ovals (one of them double) were drawn in the centers of the bowls. There is also a sign in the form of an empty oval with black circles (full moons) on its sharp ends . In the sign system of the settlement of Dobrovody there is a polygram , which consists of a black oval drawn on a pen, and two signs-icons of the moon, connected by a grid: .





A large number of painted utensils from the settlement of Taliarki allows us to conduct the most detailed studies of the use of a lenticular oval in the sign system of the Tomashivka group. We have ten variants of a simple (not in blocks) image of the sign. Most often (14 graphs) it is filled with an oblique grid: . 13 times there was a drawing of a black oval: . 11 times inside the oval there are wavy ribbons (sign-icon of water): , 9 times there were empty signs: , ovals filled with a straight grid - 8 times . Six ovals are filled with a straight vertical line  that intersects horizontal lines: . Three ovals are filled with oblique lines: , two-horizontal lines:  one - a vertical line: and once a negative wavy ribbon inside the oval is filled with a square grid: .

On one biconical vessel a polygram, consisting of an image in the first tier, a handle, a lenticular oval with a vertical line inside, plants and inclined ladders in the second tier, and plants in the third tier of the



painting: . Besides plants,  triangles were drawn above the lenticular ovals:  moon:  inclined ribbon filled with a grid: , and signs-icons of water on the third tier of the painting: . On the bowls, the sign in the form of a lenticular oval | is replaced by black circles - the sign of the full moon.



Another similar painting scheme once depicts a lenticular oval drawn instead of the other signs located here. Among the utensils from the settlement of Taliarki, there is a large series of cups, which allows obtaining a paradigmatic series of signs applied between the metopes. This, in turn, makes it possible to make the most documented observations of sign substitutions in the same context. It is noticeable that



most often the sign-icon "plant on a hill":  (we have 12 signs) is replaced by a sign in the form of lenticular ovals: . In addition to plants they are replaced by signs in the form of vertically arranged small dashes: , sign in the form of,  oblique cross: , quadrilateral filled with a grid: , sign in the form of a crest: . All these signs occurred from one to four times. Often, where these signs were depicted, only black "bumps" were drawn, sometimes with lines, possibly signs of grass: .





As already mentioned, the lenticular oval was often associated with the signs of the full moon in the form of a black circle. Black circles flank the following oval: . Lenticular ovals replaced the image of black circles on the bowls next to the wavy ribbons in the centers of the bowls:  or surrounded by lunar signs:  With signs in the form of a ladder  departing from its sharp ends. Another image of a lenticular oval in the center of the bowl is combined with signs in the form of a ladder:  departing from its sharp ends.







In the sign system of the settlement of phase III of this group of Taliunki for the first time, there was a union on the principle of vertical mounting of lenticular ovals and signs-icons of plants, which allows interpreting ovals as signs of grain (Videyko M. Y., 1989., p. 47), and its semantic field should be reconstructed as follows: **plants** (4 graphemes) - **full moon** (3 graphemes) - **the crescent moon** (3 graphemes) - **water** (2 graphemes) - **ladders** (2 graphemes).

The connections of the lenticular oval with the icon-signs, which were already in the sign system of Taliunki, are represented in the paintings from the settlement of Maidanetske. There are 15 more variants of simple lenticular signs here. All new variants occurred only once. These include a horizontal oval filled with sloping lines crossed by a horizontal line: ; oval with a wavy ribbon, which is filled with a grid (there are several variants of these signs): ; an interesting polygram, consisting of a lenticular oval and a ladder in its middle: .

As already mentioned, very bright contexts of ovals allowed us to perceive them as signs of grain (Videyko M. Y., 1989., p. 47). Most often, a pattern of one plant is observed above them (8 times):  once next to the picture of the plant there are triangles:  double plants are depicted twice: .

Five times above the lenticular ovals are drawn triple signs-icons of plants:  One of them is complicated by flanking black circles - signs full moon lenticular oval and the image of grass (?)  under them. In another polygram, drawings of ladders are attached to the lenticular oval on two sides:

. Plants were also depicted in the form of three branches growing from one point  on one polygram next to the plant depicted a triangle:  and on the second under the oval painted grass: 

(?). In addition to plants, triangles "grow" out of lenticular shafts:  an inclined ribbon filled with a grid: , double and triple lenticular ovals:  , as well as on Taliunki,  mutual replacement of signs * in the form of plants (18 graphemes) and lenticular ovals-signs of grain (20 graphemes) is



well noticeable. As if to illustrate the close connection between these two signs, three cups in one triglyph

depict a plant on a "hump" , and in the other - also on a "hump" - a lenticular spike. We also have a grapheme, where the lenticular oval and the plant are depicted as a decent "hump": In addition to these signs, the process of replacement involved signs in the form of a ladder (4 graphemes), vertically arranged lines (6 graphemes) and ribbons filled with a grid (2 graphemes). As already mentioned, sometimes lenticular ovals were grouped in pairs. Once such signs were found on the cup, three times - in polygrams on the second tier of the painting. Another double image of the grain marks, which are located inside a large oval, is drawn in the center of the bowl. They are flanked by six signs of the full

moon and two signs of water: . Double images of lenticular ovals are the third tier of the painting of a fragment of a biconical vessel. In its second tier, the plant is depicted with triangles arranged side

by side:  (the lower is not preserved)

Lenticular signs of grain are drawn in complex graphemes, which include the signs-icons of the moon, they seem to grow from the sickles drawn below:  consist of lenticular ovals drawn next to black circles and wavy ribbons. Signs of grain or flanked by black circles - signs of the full moon (5

polygrams): , or combined with them: .

Complex polygrams on bowls consist of lenticular ovals drawn next to black circles and wavy ribbons.

One such polygram is preserved on a fragment of a bowl:  Six times in the centers of bowls grain

marks are combined with water signs . Sometimes groups of grain marks were painted inside bowls. They formed rows or, which is rare, were arranged chaotically. Once the marks of the grain form a cross-

shaped composition: . In the center of one bowl is drawn a complex polygram, consisting of a central

oval and four other ovals attached perpendicular to the central, two to its sharp ends: .

Observations of the signs that replace the ovals on the craters add to its paradigmatic series another sign-icon "animal".

The semantic field of the **lenticular oval** in the sign system of the settlement of the III phase of the Tomashivka Maidanetske group is reconstructed as follows: **plants** (22 graphemes) - **full moon** (10 graphemes) - **water** (8 graphemes) - **the crescent moon** (3 graphemes) - **ladders** (2 graphemes).

The sign system of the settlement of Talne II does not add new data to the understanding of the semantic field of the lenticular oval. On the bowl, the signs-icons flank the wavy ribbon - the sign of water, i.e. they

replace the signs of the full moon: .

The signs of the full moon (black circles) were drawn on the sharp ends of the sign of the grain  located in the center of the bowl. On the cups, the marks of the grain changed to the marks of the plants. In the sign system of the settlement Talne II, the **lenticular oval** has a rather limited semantic field: **water**, **full moon** (one grapheme of each sign). Similar connections of the grain sign can be observed in the Tomashivka sign system. In the center of the bowl, it is replaced by black circles - signs of the full moon

and the sign-icon "animal". Once his image is flanked by two full moons:  This sign is replaced by

a triple black circle sign: . On the cups, as in previous sign systems, the signs of the grain are replaced by the signs of plants.

In the IV phase of the Tomashivka group, in the eponymous settlement, the semantic field of the lenticular oval has the same appearance: water is a full moon. Three times in the center of the bowl ovals seem to

be cut with a wavy ribbon: . Once the lenticular oval in the center  of the bowl is filled with

oblique lines: . Similar relations of the studied sign are observed in the sign system of the settlement of the same group Chschlsnik.

The semantic field of the **lenticular sign** in the settlements of the Chechelnyk group is very limited and consists only of a graph of water, their equivalent here was the sign of the **full moon**.

In the sign systems of the settlements of the Petreny group, lenticular ovals were depicted very rarely, and iconic signs are not observed in their surroundings. Only when referring to the series of signs that depicted in the same place the same type of vessel (paradigm), you can outline their semantic field. Thus, in Bernashivka it looks like: **crescent moon - crescent moon and water - animal - an animal with a red circle** next to it (full moon sign) - ladder.



In the Lipchany sign system, the lenticular oval is replaced by the sign-icon "bird": 

At the eponymous settlement of the Shipintsi subgroup, lenticular ovals were painted on the second tier of the amphora painting. There are eight such signs in the materials published by Kandyba. In four cases,

under the black lenticular ovals are drawn signs-icons of animals: . In four more cases, this

time near the medallions filled with lenticular ovals, animals are also depicted (Shipintsi B): .

Lenticular ovals in the sign system Shipintsi B are painted (12 graphemes): ; have wavy ribbons inside

- signs of water (11 graphs): ; lines (red or black):  two signs - empty: . In the sign system of the memorial settlement of the Shipintsi group, a lenticular oval was used quite often.

In the symbolic system of the memorial settlement of the Shipintsi group, a lenticular oval was used quite often. Observations of its use allowed to reconstruct its semantic four characters filled with oblique fields: **water** (11 graphemes) - **animals** (10 graphemes). Paradigmatics adds more signs of **water**, **full moon**,

plants, and the crescent moon. Paradigmatics adds more signs of water, full moon, planets, and the crescent of the moon.

Another fragment of the vessel next to the red lenticular oval is a wavy line - a sign-icon of water. The semantic field of the lenticular oval in the sign system of the settlement Varvarivka XV has the following

form: crescent moon - water . Bădragii type and later Ofatiņi and Usatove cemeteries were painted very rarely, their semantic fields cannot be determined, because there are no icon signs near them. Only once a lenticular oval is depicted next to the sign-icon "water" on the amphora from Purkary, the burial

site of Usatove type  .

Wavy ribbon

Already on the painted ware of the early monuments of the stage of the BII of the Rakovets group, the wavy ribbons of the flank were marked with icons in the form of a crescent moon (Rakovets, Florești V):





. This suggests that the number "three" is equivalent to the sign of the moon: In the sign system,

Nezvysko III  wavy ribbons flank a vertical lenticular oval on the arm  : at this point they are

replaced by crescents of the moon:  the whole composition resembles a wavy ladder:





On bowls painted with diagrams in the form of the number "8", small ovals are replaced by crescent moons and black circles. On bowls from the settlement of Volodymyrivka two wavy lines end in black circles - signs of the full moon. Also, water icons were depicted on bowls painted with the figure "8",  where they are replaced by a black circle , a lenticular oval, vertical lines in the center of the medallion with semi-ovals.

On the bowl from the settlement of Pischana, as well as on some Volodymyrivka settlements, the wavy line ends with black circles - signs of the full moon: . The vertical wavy ribbon happened in the

border of the second tier of the amphora painting: . On the inner side of the crown of the crater



the signs of water and the full moon are depicted next to the crescent of the moon: . On the

vessels of Konovka settlement, to the second - black circles  complete the wavy ribbons on the painting scheme of the bowl in the form of the number "8": .

At the BI stage, the water signs have the following semantic field: **full moon**, 1 - from Kolodyste - the **crescent moon** (1 grapheme from Rakovets, 1 - from Florești V, 1 - from Pischana) - **lenticular oval** (grain sign) (24 graphemes from Nezvysko III, 4 - from Konovka).

On painted vessels of phase II In the Tomashivka group, wavy line signs were used very rarely. Thus, on the dishes from Dobrovody wavy ribbons are on the "front" scheme of painting the amphora in the areas (between the "faces") under the handles. They were included in polygrams, which consisted of large ovals around the handles. Horizontal lines are drawn on them, and wide wavy ones are located horizontally

below them ribbons - watermarks: . Interestingly, in these areas in other cases depicted moon-

shaped negative shapes:  black lenticular ovals: , once in combination with signs-icons in

the form of horizontal crescents of the moon: , black circles: . Another wavy ribbon from

this settlement is painted on a biconical "imported" Chechelnyk vessel under the handles: . In the

settlements of the III phase of the Tomashivka group, water-icons were painted exclusively on bowls. Only in Talianki, there was one polygram on a biconical vessel, on which vertical wavy ribbons were placed

in the third tier of the painting:  Interestingly, in the third tiers of the painting on a similar vessel there

were triangles and signs-icons of plants compared with ladders. Wavy ribbons sometimes ended with the sign of the full moon: . One such polygram is on the bowl, and the other - on the biconical vessel. The second case of using the sign-icon "water" is not in the bowl. Wavy ribbons were





also depicted on bowls in ribbons, one after the other: . In one case, in the place where black single, double and triple circles, lenticular ovals were depicted, a sign-icon of water was drawn around the months that complete the ribbons. In another scheme of painting a bowl, a wavy line is flanked by four

signs of grain (two on each side): . On the bowls, painted with diagrams in the form of the number "8" (Taliianki), in large ovals are drawn double wavy ribbons, and in small-black circles-signs of the full

moon:  which sometimes were accompanied by signs of grain. Once there was a sign of water, which ended with the sign of the full moon. The six already mentioned marks of grain, placed in the center of the bowls, are combined with the signs of water. This also includes the already mentioned polygram, which consists of grain signs (depicted in the center of the bowl), full moon signs that flank them, and water signs that also flank the grain signs. Wavy lines pass through the center of the bowls, wherein other cases they were depicted as single or double signs of the full moon. Water signs also form swastika-like or cross-shaped compositions on bowls, when they are depicted by four "streams" flowing into the center

of the bowl. In one case, the sign of the full moon was drawn in the centric compositions: 



The semantic field of the **wavy ribbon** in the sign systems of the settlements of the Tomashivka III phase looks like this: **the sign of the grain** (8 graphemes from Maidanetske, 3 - from Talne II), **full moon** (6 graphemes from Maidanetske, 3 – from Taliianki) - **the crescent moon** (2 graphemes from Maidanetske, 1 – From Taliianki, 1 – from Talne II). In the sign systems of the Chechelnyk group, wavy ribbons are

combined with lenticular ovals (Cherkasiv Sad II): , , , (Chechelnyk): ; in the schemes of painting in the form of S-shaped arcs, wavy ribbons were replaced by black circles:





In the sign systems of the Chechelnyk group, the semantic field of the sign-icon of **water** is to some extent formally similar to Tomashivka: **lenticular ovals - black circle**. But, unfortunately, it is not possible to interpret graphemes in the form of a black circle as a sign of a full moon, and the lens similar ovals - as signs of grain, because in these sign systems, in contrast to Tomashivka, they are not surrounded by signs-icons in the form of sickles and plants.

In the paintings of the Petreny group wavy lines and ribbons were used in the same way as in Tomashivka – most are on bowls. Here the water signs are flanked by black circles (Petreny): . In their places in

other cases double moon-shaped signs (Petreny) were drawn: , small quadrilaterals filled with parallel lines, , arcuate figures filled with lines: . In small ovals on bowls, painted with a diagram



8 in the form of numbers, sometimes depicted signs of water. Of these, two signs are combined with lunar sickles (Petreny): . On similar bowls of the Bernashivka settlement in small ovals in most

cases water signs were drawn (5 graphs); once the lunar signs are located next to the red circles: 

In another case, in place of these signs drawn a double-cross: . Moon signs (black, rarely red) flank

wavy lines and ribbons: . In one case, the red wavy ribbon is flanked by eight signs in the

form of red crescents of the moon: . Flanking the ribbon with red circles, which are usually applied to the places where the moon signs are usually depicted, suggests that the red circles in the paintings of the Petreny group are signs of the full moon, and the sun, as it is sometimes considered:



 On one bowl is a polygram in the form of a wavy line ladder sign: 

Wavy lines on another bowl are depicted surrounded by crescent moons and a full moon sign in the center. This polygram has already been mentioned in the analysis of the black circle sign (see previous sections). As already mentioned, wavy lines are very rarely drawn on other types of utensils. Yes, they are depicted above the handles of an amphora, which is painted "owl face". At the bottom, under the handles, there



are mountain-moon-shaped figures with lines that depart from the horns and the middle of the sign 

On another amphora with an "owl face" , there is a combination of the moon sign with a ladder sign

. On amphorae with a "front" painting a wavy ribbon negative lunar signs:  and drawings in the

form of two black circles:  - signs of the full moon. Another wavy line surrounded by moon signs is depicted in the second tier of biconical vessels: 

In this area, other biconical vessels were painted with animals, sometimes with red circles, crescents of the moon signs in the form of lenticular ovals, a ladder, and a large number of symbols. water signs were rarely depicted in the sign system of the Lipchany settlement. On the bowl, which is painted with the figure in the form of the number "8", in







large ovals there are wavy ribbons, and in small ovals, there are lenticular ovals with wavy lines  - water signs inside the oval near the handle: 

The semantic field of the sign-icon "**water**" in the Petreny group can be reconstructed as follows: **crescent** moon (8 graphemes from Bernashivka, 3 - from Petreny) - **full moon** (3 graphemes from Petreny, 2 - from Bernashivka) - (1 grapheme from Bernashivka). The paradigm of the sign adds here the signs of animals and anthropomorphic faces.



On the bowls from the settlement of Stina IV, wavy lines and ribbons pass through the centers, wherein other cases black circles-signs of the full moon were drawn. On bowls painted with diagrams in the form of the number "8", wavy ribbons in large ovals are flanked either by signs-icons in the form of crescents

of the moon: , or by black circles surrounded by concentric lines:  - signs of the full moon.

There are lenticular signs: small ovals of these bowls were painted with double-crosses:  an oblique

grid.  In another bowl, a wavy line is connected to a black circle: . Another combination of wavy ribbon with a black circle we have on the amphora, which is painted by the scheme "owl face": . On the cups painted by metope scheme, in metopes, wavy lines:  change to the crescent moon  and animals .

Thus, the semantic field of the sign-icon "water" in Stina IV is similar to the Petreny: **full moon** (3 graphemes) - **the crescent moon** (1 grapheme). Paradigmatic connections add an **animal** grapheme and an **owl face**.

In the sign system of settlements of the Shipintsi group, wavy lines, except for bowls, were depicted in the second tier of amphora paintings. Thus, on the amphorae from the settlement of Shipintsi B polygrams, consisting of signs of water and black circles, are located in the second tier: . In these places in other cases painted lenticular ovals, united by festoons, sometimes with animals under them and without them as well as planets and moons. In some cases, the head of the snake is located at both ends of the wavy body, forming a two-headed snake: . A similar sign is on the cup.

On another amphora, in the second tier of the painting, which is divided into two metopes, in each of them are drawn two snakes, and under them - four crescents of the moon: .

In this area, they were replaced by the sign-icon "animal". On the bowls, painted with diagrams in the form of the number "8", in large ovals depicted the signs of both snakes and water. In another scheme of painting the bowl, the water sign is flanked by crescents of the moon: . Signs of the snake -





water is also on a pear-shaped vessel:  (2 graphemes from Bilche Zolote Verteba I). Observations on the replacement of signs are added here by the signs-icons of animals and plants. "snake", in the vast majority of red color. But, taking into account that in many cases it is difficult to distinguish them because they occur in the same context, we consider it appropriate to combine these

signs under one name - "snake - water".  settlement of the second half of the stage CI-γI Valea Lupului II wavy signs of the serpent - water is drawn next to the signs-icons of the moon surrounded by

small lines:  vessels with high cylindrical necks divided into metopes, in the second tier of the painting single and double signs of a snake - water often with groups of triple vertical lines surround the image of animals. In one case, there is a replacement of the signs of the snake - water with lenticular

signs in the form of crescents of the moon: and animals: ovals: .

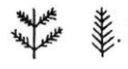

On the anthropomorphic vessel in the form of a body without a head, on its "sides" in the upper part, there are signs in the form of bucraniae (?). Perpendicular to them on each side there are vertical red wavy ribbons flanked by red signs-icons of the moon: .

“Tangentenkreisband” in the tangents there were drawings of a snake - water surrounded by W-shaped signs . In large ovals, they are replaced by a B-shaped sign (1 grapheme): . In another case, there is a sign in the form of a wavy line. Signs of a snake - water in the second tier of amphora paintings are replaced by signs of the moon:  and plants: . Also, the equivalents of the studied sign, in cases of its image in large ovals, were signs in the red circle and a vertical ribbon with two black vertical hemispheres on it: . The grapheme of water in combination with this sign is depicted on an amphora, which is painted by the scheme “owl-face”: . The semantic field of the sign “snake-water” in the sign systems of Varvarivka XV and similar settlements view crescent moon (2 graphemes from Valea Lupului II) - animals (2 graphemes from Valea Lupului II) - anthropomorphic vessels (1 grapheme from Valea Lupului II, 3 - from Varvarivka XV). Signs of plants are included in this field, paradigmatically, only in the sign system of the settlement Varvarivka XV. Wavy ribbons on the dishes of the later settlement Bădragii Vechi were painted on all types of dishes. They were applied on both the outside and the inside of the bowls, painted with the scheme in the form of the number “8”.

In large ovals we have a sign in the form of a double grapheme of water and the moon next to them:



In small ovals bowls in most cases were drawn signs of water and once a sign in the form of a

triple cross with black circles at the ends:  in the form of rows of triangles:  and rhombuses

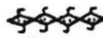
with “hooks”:  painted in tangents that connected the red medallions, crosses in medallions and medallions with black hemispheres in their scheme “Tangentenkreisband”. In one case, next to the sign

of the snake - water depicts an animal: . Also, we have another combination of the sign of the snake

equivalent to the water in the form of a series of rhombi, which intersects the image of bovid: . The red signs of the snake - the water on the “Tangentenkreisband” schemes were surrounded by wavy black

lines of smaller size: .

Large red signs of the snake - water, surrounded by their smaller equivalents in the form of double wavy

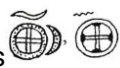
lines, rows of rhombi with “hooks”, were drawn on bowls . In two cases, the iconic signs “snake

- water” are depicted next to crosses in medallions: the polygram is drawn on the scheme of painting “owl face” in the areas of “eyes”. Double signs-icons of the serpent - water sometimes flanks the signs in the

form of a vertical black or red ribbon with vertical semicircles, drawn on their sides: .

Single black signs of a snake -water flanking a vertical red ribbon filled with red “rhombi”: .

On an anthropomorphic vessel without a head, red vertical snake-water signs flank a wide vertical ribbon

filled with oblique crosses, which are drawn under the protrusions - “chest”.  It is here, in each of the

four ovals connected by tangents, we have signed in the form of two red circles, a vertical sign-icon of a

snake - water, and a W-shaped figure: 

On the second tiers of this vessel painted signs of a snake - water and their equivalents - rows of red rhombi, triangles, rhombi with "hooks". The vertical lines are sometimes flanked by double water-snake signs. Inside the large vertical stripes that divide the two upper painting zones into metopes, wavy lines were drawn, grouped in two or three: double W-shaped signs, triangles, oblique crosses, and vertically arranged "Tangentcnkreisband" schemes with black circles. In some cases, the vertical stripes are filled with red paint, in the third tier of the painting of this type of vessel, in addition to the signs of the snake - water, graphemes were depicted in the form of oblique lines, ending in black circles; double wavy ribbons with black circles in their middle; red W-shaped signs, sometimes adjacent to the lines outlined by black dots. Interesting paradigmatic series of the sign of the snake - water, we can see in the paintings of craters. Here, too, it is part of a set of signs, which consisted of a vertical red line outlined with black dots, a vertical ribbon with two vertical black hemispheres. Inside these ribbons are drawn rows of red rhombi and oblique crosses. The straight cross is depicted next to the sign of the serpent - water on the amphora:



The sign system of the Bădragii settlement Hancăuți I is very similar to the previous one. Signs of water were applied on the outside of the bowls, painted in the form of the number "8". In large ovals, they were replaced by U-shaped signs, in small ovals the wavy ribbon was replaced by vertical and horizontal lines, a vertical row of W-shaped signs, a straight double-cross, a vertical row of rhombuses with W-shaped signs attached to them on the sides, a vertical tape filled with mesh. On the cut-spherical bowls, painted with a central straight line and two side arcuate ribbons, the signs of the snake - water is depicted next to rows of rhombi and W-shaped figures. Also, they are replaced here by images of triangles, rows of W- and M-shaped figures, and groups of wavy lines. On other bowls, painted in the form of a cross, in the ovals on the free fields formed by them, instead of the cross graphs often used here, the equivalent of a wavy ribbon-sign of a snake is once depicted - water and triangles with "hooks".



In the paintings "Tangentenkreisband", in medallions instead of crosses, triple, and four hemispheres, red

medallions once there were signs in the form of two-wave lines-signs of the snake - water: . But the most important place for the use of the sign-icon of water were tangents, there are usually four of them and each depicted one or two signs in the form of large red wavy ribbons. Sometimes they are surrounded by double W- and M-shaped signs, double wavy lines, drawings of animals along with double W-shaped signs and double wavy lines, a plant sign. In the "owl face" painting schemes, double wavy lines are



depicted in ovals,  where in other cases the crescents of the moon, empty ovals, and medallions were painted surrounded by the crescents of the moon. On dishes with high cylindrical necks, the sign of a snake - water is replaced by a sign of an animal; in the middle, there is a wavy ribbon in combination with a vertical stripe flanked by two red vertices. It is noteworthy that near a similar sign, located next to a

place of the wavy ribbon, inverted M- or W-shaped signs are shown .

Central sign semicircles: these polygrams are in other cases replaced by rhombi with W-shaped signs on

the sides:  vertical rows of ovals with "hooks" that intersect in a similar horizontal row:  ; a

horizontal row of rhombuses  with a vertical red ribbon adjacent to two iconic signs: water-snakes

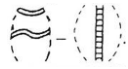

and animals:  A similar paradigmatic row, together with large W-shaped figures:  is also observed on the upper tiers of this type of vessel. Wavy lines are sometimes replaced by signs in the

form of ladders: .

Paradigmatic series of wavy signs on the paintings of dishes from sites 1 and 2 of the settlement of the Bădragii type Konovka is similar to the one just described and does not add new signs to its semantic field. "Snake - water" has a Bădragii semantic field: **crescent moon** (4 graphemes from Bădragii Vechi) - **full moon** (2 graphemes from Bădragii Vechi) -an **animal** (1 grapheme from Bădragii Vechi, 3 - from Hancăuți I) - **plant** (1 grapheme from Hancăuți I) - "**belly**" of anthropomorphic vessels (1 grapheme from Bădragii Vechi) – "eyes" of an anthropomorphic jug (1 grapheme from Bădragii Vechi). Its equivalents were signs-symbols in the form of rows of triangles, rhombuses with hooks and without them, W- and M-shaped signs, straight vertical and horizontal lines, and, possibly, signs in the form of a cross.

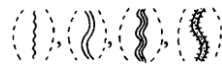
Wavy lines with all their sign equivalents were often used. in the sign system of the settlement Zhvanets. Here the signs of the serpent - water - were either drawn in the centers of large lenticular ovals:

, or, more often, flanked by black or red straight ribbons on bowls. In addition to the

signs-icons of the snake - their waters were flanked by red circles: , circles with dashes: ,

W- and M-; groups of three vertical lines: ; double wavy lines In the paintings of cut-spherical



bowls , in addition to the known  equivalents of the sign-icon  "snake - water", once a red

circle with dashes: . The paradigm depicts a straight cross on a round vessel: a series of signs-icons of a snake - water expands due to drawings of an oblique cross, including next to the image of an animal

in the upper part; sign-icon of a "bird": , a combination of the sign of the snake -water with W-shaped signs. From the lower tiers, images of circles with dashes are added here, which diverge in all directions:

.

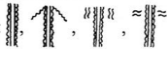
The sign of the snake-water on the painted vessels of the settlement by paradigm. At this time, the bright signs-icons of the moon (sickles) disappear, and therefore there is no reason to interpret the signs in the form of red circles with or without dashes as signs of the moon. But the material involved in the analysis does not allow them to be considered signs of the sun. Therefore, the question remains open. The only thing that is observed in the ornamentation of Zhvanets is that the signs are in the same series as the icon-signs "snake - water"

On the dishes from the Ofatinți cemetery, wavy ribbons flank straight lines, which are cruciformly painted bowls: . In ovals, wavy lines are replaced by rows of W- and M-shaped signs. In one case, the wavy lines form across here: .

In the centers of the bowls, the “snake-water” signs outline circles, in which in some cases they form a cross:  the image once again emphasizes the close connection between the signs of the cross and the snake-water, which is not manifested. At the level of symbol signs, only the connections of this sign with crosses (and through them with the symbols of the center) and W-shaped signs are visible here, which are either combined with wavy lines or replaced by them. In the scheme of painting “owl's face” signs “snake - water” occurred in the “eyes” of anthropomorphic vessels. For symbolic signs, wavy ribbons were replaced by W-shaped signs, triangles, and vertical ribbons. The signs of the serpent-water also flanked the oblique lines that formed the cross. Of the new symbolic phenomena, we can note the formation of wavy lines of the sign in the form of a cross in the center of the bowl. And although there are very few such utensils in these settlements, it can be seen that the studied sign was depicted in the same contexts as in monuments such as Ofatinți and Usatove.

Cross symbol in a circle (medallion)



On the utensils from the settlements of the Rakovets group, this sign is on the bowl, which is painted with the scheme in the form of the number "8", in large ovals with black circles in the free fields: ,

and in small circles with black lenticular ovals (Rakovets): .

Similarly, a cross in a medallion with black circles can be found on a fragment of a vessel from Florești: . Black circles next to crosses could be replaced by red ones. Such a polygram is drawn on an amphora with a "face" painting, in the area between the faces from Nemyrivske. The second tier of the ornament of this amphora depicts medallions with crosses, which are united by tangents. On another amphora with a similar painting between the

"faces" are drawn negative crosses and circles in free fields: . Once again, the combination of the oblique cross in the medallion with the "front" scheme of painting is on the cover of a pear-shaped vessel.

On the vessels of the early settlements of the BI stage (Rakovets group), the semantic field of the sign "cross in a circle" hypothetically has the following form: **anthropomorphic faces - full moon - grain**.



On the dishes from the settlement of Nezvysko III crosses, made of red or black paint, were painted in the centers of the lids: , . Crosses on craters are formed by lenticular black ovals: 

Sometimes they took the form of a four-rayed star: 

In the sign system of the settlement Nezvysko III, the semantic field of the cross in the circle is reconstructed as follows: **the center** (10 graphemes) - **grain** (2 graphemes) - **water** (1 grapheme). In the symbolic system of the settlement of Volodymyrivka, a cross in a medallion with black fields painted with

black paint appeared only once on a fragment of a vessel: .

Among the signs of the settlement of Pischana, we have two crosses in medallions. In one case it is







depicted on a cup with a handle: , , in another - it is located on an amphora, which is painted

scheme "Tangentenkreisband", where it is depicted in medallions connected by tangents: . The cross in a circle, formed by lenticular black ovals, was located on an amphora, which was painted bath

"face" scheme: 

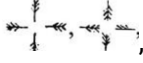
In the paintings of the dishes of the settlement of Pischana, the semantic field of the cross in the circle is connected with the "frontal scheme" and the signs of the grain. In the Kolodyste settlement, lids were painted with crosses in circles, and sometimes they took on a ladder-like appearance.

In the paintings of the Tomashivka group, the cross in the medallion was hardly used among the small signs that were often replaced. Only in the sign system of the settlement of Maidanetske, we have two such signs. One of them is on the scheme of painting a biconical vessel in areas where large black ones were usually painted car. The second is on a small fragment, so its context could not be determined:

. Crosses in sign systems of this group were used as schemes of painting bowls (Talianki): . Sometimes crosses on bowls were formed by drawings of plants (Talianki):  (Maidanetske): , and lenticular ovals - signs of grain (Maidanetske): . In one ladder (Maidanetske): . In this case, the sign of the full moon is drawn in the center of the cross-shaped composition on the bowl (Maidanetske): .

The semantic field of the sign “cross in a circle” in the sign systems of the Tomashivka group can be reconstructed as follows: **center** (3 graphemes from Talianki, 8 - from Maidanetske) - **full moon** (3 graphemes from Maidan) - **plants** (1 grapheme from Talianki, 3 - from Maidanetske) - **grain** (1 grapheme from Maidan) - **ladder** (1 grapheme from Maidan).

In the sign system of settlements of the Chechelnyk group, the cross in the medallion is in one case painted in a very bright context - surrounded by two crescents of the moon, which thus formed a picture of the lunar cycle: right crescent - the moon in the first quarter, cross in the medallion - full moon, left crescent (moon in the last quarter) (Cherkasiv Sad II): . Most settlements of this group are part of a fairly wide range of paradigmatic signs-symbols, which, unfortunately, except for the ladder sign (Chechelnyk), do not include icon-signs.

Thus, in the Chechelnyk group the semantic field of this sign has a rather limited kind: the cross in the medallion in the sign system **full moon** (black circle) - **ladder**.

As already mentioned, in the analysis of the sign-icon of water in the Petreny group, the cross in the medallion is included in the paradigmatic series of water signs, which were depicted in small ovals on bowls, painted with the scheme in the form of the number “8”. This can be seen on the bowls from Bernashivka. Also, the crosses in the medallions are part of a large paradigmatic series of signs, which were applied as the central elements of the painting “Tangentenkreisband” - medallions connected by tangents (Petreny, Bernashivka, Lipchany). Among the large number of signs-symbols there was a sign in the form of an animal (Petreny), and on one pear-shaped vessel, next to the crosses in the medallions, depicts fantastic anthropomorphic figures in Petreny .

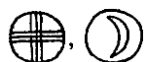

Signs in the form of crosses in medallions were included in several images, where instead of “eyes” “owl faces” were painted (Petreny, Bernashivka, Lipchany, Stina IV). On the “owl faces” from the settlement of Lipchany the “eyes” have the form of crosses or crescents of the moon in medallions (Lipchany):



Crosses were also painted on pear-shaped lids (Bernashivka, Lipchany, Stina IV). In the latter case, the cross is formed by ladders. Also, they were depicted on bowls. Along with the crosses, in two cases, the crescents of the moon were applied, in one case - the crescent of the moon in a free field and the sign of the full moon in the center of the cross; in another case in the free fields were red circles (Bernashivka):



Crosses in medallions next to the signs-icons of the moon in the paintings of the settlement Stina IV. One time it is depicted on a biconical wide-necked vessel, which is depicted by the



scheme "Tangentenkreisband": , and the second - on the "belly" of an anthropomorphic vessel. In this case, the circle in the medallion is combined with the crescent moon: .

Observations of the use of the **cross in a circle** in Petreny sign systems (and the approximate sign system of the settlement Stina IV) allow us to reconstruct its semantic field as follows: **crescent moon** (3 graphemes from Bernashivka, 1-from Lipchany, 3 - from Stina IV) - **full moon** (2 graphemes from Bernashivka) - **anthropomorphic figures** (1 grapheme from Petreny) - "eyes" of anthropomorphic vessels (1 grapheme from Petreny, 3 - from Bernashivka, 1 - from Lipchany, 1 - from Stina IV) - "belly" of the anthropomorphic pot (1 grapheme from Stina IV). Replacing signs adds more water, animal, and ladder signs.

On ware of the Shipintsi group crosses in medallions were represented in the center of lids (Shipintsi B). Also, the studied sign is part of a horizontal block, which consists of three superimposed ovals of medallions. The cross in the medallion is depicted at the top of the block, in the center - a medallion with

a black circle in the middle, and at the bottom - an unfilled medallion:  On ceramics from Bilche Zolote



Park III crosses were painted on lids and amphorae with "front" painting, between "faces":  in the form of a cross in a circle in the paintings of the Shipintsi subgroup allow to reconstruct its semantic field as follows: the center - "face" images were located in the tangents. On one such amphora from the settlement of Varvarivka XV above the medallion with a cross inside, there was a sign in the form of a

ladder:  in the form of a black circle (signs of the full moon): . In one case, in the middle of the crosses were depicted signs in the form of a black circle (signs of the full moon): .

The semantic field of the **cross in the circle** in the sign systems of settlements of the Cucuteni phase (and close to it in time) has the following form: **crests of the moon** (1 grapheme from Valea Lupului II, 1 - from Varvarivka XV) - **full moon** (2 graphemes from Varvarivka XV) - **ladder** (1 grapheme from Varvarivka XV) - "eyes" of anthropomorphic vessels (2 graphemes from Varvarivka XV).

A paradigmatic series of signs in small ovals of bowls, painted with the scheme in the form of the number "8", from Bădragii Vechi has already been mentioned in the analysis of the semantic field of wavy lines,

so just remember that the cross with black circles at the ends of the medallion: . On amphorae painted with the "Tangentenkreisband" scheme, the "crosses in medallions" signs were replaced by red and blank medallions, and the black ones half-painted here were half-painted. Along with them in the tangents in almost all cases depicted the signs "snake - water" and their equivalents. Once there was a

picture of an animal: . Crosses in medallions were often placed in the "eye" areas of utensils painted with the "owl face" scheme. In one case, a polygram was drawn here, which consisted of images of the cross medallions, the sign-icon "moon" next to it, and the sign-icon of snake-water above:  Also, the sign in the form of crosses formed schemes of painting bowls.

On the dishes from the settlement of Hancăuți I crosses were painted in the centers of bowls. Four crosses were depicted on free fields formed by cross-shaped bowls. We have one case when crosses in

these areas were replaced by the equivalent of a snake - water: a broken ribbon with “hooks”: The same grapheme of a snake - water is part of a paradigmatic series of signs that replace each other in medallions, which include crosses, black semi-red, and black circles. Crosses in medallions on this scheme (“Tangentenkreisband”) are surrounded in tangents by signs-icons of a snake - water. To understand the sign “cross in a medallion” the grapheme which is represented on the scheme of a list “owl face” is very important. The “eyes” of the anthropomorphic scheme consist of a drawing of the moon in the first quarter (right sign), a medallion with a double-cross inside (center) and a crescent moon in the last quarter, located “™” “™” next to it. Double M-shaped signs - equivalents are drawn above it a sigh of the

snake-water: . Flanking the grapheme of the cross in the medallion with lunar crescents allows us to interpret it as a sign of the full moon.

In the sign systems of settlements of the Bădragii type, the semantic field of this sign has the following form: **snake - water** (2 graphemes from Bădragii Vechi, 2 - from Hancăuți I) - **full moon** (1 grapheme from Bădragii Vechi, 1 - from Hancăuți I) - **“eyes”** anthropomorphic vessels (1 grapheme from Bădragii Vechi, 1 - from Hancăuți I). In Târgu Ocna-Podei, the cross in the medallion is depicted in the middle of a lid. Besides, on another vessel we have an interesting polygram, which consists of relief bucrania and a triple oblique cross located between the horns; under the relief, there is a sign that resembles bucranium in its

outlines: 

Analysis of painted utensils from Târgu Ocna-Podei allows reconstructing the semantic field of the sign “cross in a circle” in the following form: **the center - an animal** (bovid). At the ends of the ribbons, which form a cross on the bowl, are depicted the crescents of the moon (Hadaczek K., 1914., Vol. IX. 60). Another red cross in a circle is drawn in the center of the lid.

The semantic field of this sign in the sign system of Koshilivtsi Oboz is as follows: center - crescents of the moon point to its vivid “lunar” contexts and allow us to interpret this sign as one of those that mean the moon, not the sun, as is traditionally believed in the literature on the worldview of the population of the Trypillia community.

Sickle-shaped sign

The sign-icon in the form of a crescent moon is included in the semantic fields of almost all analyzed base markers. Therefore, in the case of the already described occurrences of the studied grapheme in the pair of dogmatic series of one or another marker, they will be mentioned only briefly.

It has already been noted that in the paintings of the Rakovets group the signs-icons of the moon on the bowls flanked the signs of water: . Here they were replaced by the signs of the full moon:

 located one below the other, drawn on a bowl on the painting scheme in the form of the



number "8" (Rakovets): . Otherwise, a cross surrounded by black circles is drawn at this place

(Rakovets): .

The semantic field of the sign-icon "moon" in the early sign system BI (Rakovets group) has the form of a **water-full moon**. In the sign system of the settlement of Volodymyrivka, the signs-icons of the moon in

the first quarter were drawn four times as an interception on S-shaped arcs: , where it was

replaced by signs of grain surrounded by full moon . For the first time, the iconic signs acquired

here the lines that depart from the horns: , and sometimes - from the middle of the sign: .

Very often the crescents of the moon were drawn near the handles of amphorae with a "face painting

scheme: . In one case, under the sign-icon of the moon there is an inclined ladder:

.



The semantic field of the sign-icon "moon" on the painted ware of Volodymyrivka is as follows: **full moon** (4 graphemes) - **anthropomorphic faces** (7 graphemes) - **ladder** (1 grapheme). In the settlement of Nezvysko III, the semantic field of the crescent of the moon expands slightly due to the lens of a similar oval and takes the form: **full moon - water - grain**.

In the sign system of the settlement Sandy the sign of the moon is combined with a drawing of water and a full moon on the crown of the crater: . Also, the sign-icon of the moon is drawn next to the unfilled

medallion: . In the sign system of the settlement Pischana it looks like this: **water** (1 grapheme) - **full moon** (1 grapheme).

In the settlement of Kolodyste, the moon signs were drawn with horns up under the handles, on which the sign of the grain and groups of horizontal lines were applied: . In one case, a



double sign of grain and groups of horizontal lines ladders are drawn on the moon: . The semantic field of the sign-icon "moon" in the settlement, Kolodyste contains a sign of grain (1 grapheme) and ladder (1 grapheme).

On the bowls from the settlement of Sushkivka, the moon signs complete the blows, which go one after the other: . From their horns, and in one case and the middle there are mesh tapes: .

In one case, in the center of the bowl, surrounded by the moon, the signs of the full moon and grain are drawn. On one cup, in the metopes, are depicted double, arranged one below the other horizontal crescents of the moon with horns upwards; below them are drawn rectangles filled with a grid. These same figures connect the moons, they are also located at the ends of the horns and in the middle of the

upper sickle: 

Moon sickles were often drawn under the handles of amphorae with "front" schemes: . We have a complex grapheme, consisting of a moon sign, on the horns of which are ribbons filled with mesh.

It is combined with two ladders that converge at the bottom, in the middle of the figure:  Double horizontal moon signs are drawn with horns up, once flanked vertically located stripes: 

In the second phase of development of the Tomashivka group the semantic field of the **sickle** has the following form: **full moon** (2 graphemes from Sushkivka, 1 - from Chicherkozivka), **grain** (1 grapheme

from Sushkivka, 1 - from Dobrovody):  **ladder** (1 grapheme from Sushkivka). Also, the moon signs were depicted above the stickers - "chest" of the anthropomorphic faces (2 graphemes from Dobrovody)

, between **anthropomorphic faces**  and in the center of the bowl (1 grapheme from Chicherkozivka): 

In the later sign systems of the Tomashivka group (Talianki) the signs-icons of the moon, as before, complete the arcs that go behind each other. Sometimes the signs of the full moon were painted in their centers, sometimes they doubled or tripled. In addition to them, the signs of grain and water were

depicted here. Along with the moons, we find drawings of plants and groups of lines: . On the biconical anthropomorphic vessel, horizontal signs-icons of the moon were painted under the ledges -

"chest". On them, the top depicted an oblique cross:  vertical ribbons filled with a grid. In this case,

the segments of the ribbons with grids depart from the horns of the moon and its center: 

On one vessel protrusions - "chest" flank two signs of the full moon: 

On the second such vessel between groups of vertical lines are drawn with double signs of the moon: 

As can be seen from the previous signs, the moon signs are sometimes associated with grid drawings.

This connection is vividly represented on a small biconical vessel on which six double sickles surround the "neck". Under each pair of months, a rectangle filled with a grid depicts six vertical these tapes



between them are also filled with a grid: 



Moon signs with grids inside and at the ends of the horns are drawn on the ends of the arches, on the bowls:  under the handles of the dishes: 



on the biconical dishes in the second tier of the painting, above the sign: 



In this tier of painting, the lunar sign is often replaced by signs in the form of plants, fewer animals, triangles, inclined, filled with a grid of ribbons, a border of horizontal lines. Moon craters, often in



combination with a grid, were drawn on craters under or near handles. In one case, the handle with the horizontal moon sign is flanked by groups of vertical lines: 

Moon signs were depicted in the "eyes" of "owl faces" next to the signs of the full moon or its crescent . Similar signs are in the lower tiers of the painting of biconical utensils without handles: 

. A sickle and a full moon sign are drawn in the center of the bowl. In this area, it is replaced by signs of the full moon, grain, and stars. Also, the crescent moon is replaced by the sign of the full moon on a biconical vessel, which is painted with currency paintings. On the bowls, painted in arcs, one after the other, from the settlement of Maidanetske, the moon signs are surrounded by single and triple black circles - the signs of the full moon in the centers of the bowls: 



In two cases, a watermark passes through the center of the bowl: . In other cases, in arcs that end with crescent moons, depicting oblique crosses: . In the second version of such a painting arcs end, as a rule, the signs of the full moon, except in two cases. In the first, relatively wide arcs end with the crescents of the moon, and in the second with a polygram important for understanding these signs, which consists of a sickle superimposed on a black circle (the sign of the full moon): 







On the outside of one cut-spherical bowl we have linear signs stars "and the crescent moon": . Moon signs were often depicted under the amphorae handles, which are painted with "front" schemes. Here they are replaced by vertical lines, groups of horizontal lines on the handles, grain marks. Twice here are drawn polygons, which consisted of signs of grain. Polygrams, which consisted of grain marks on the handles and horizontal of the lunar signs below them: 

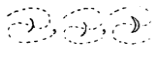

On the cup, in the metopes on the moon, a plant is drawn: . On a complex polygram, which is depicted in the area of the handle of a biconical vessel, the sign of the grain is located on double crescents of the moon, from which a triangle seems to grow (in the second tier): 

Black circles are shown in the currency scheme. They, as in previous paintings from Taliانki, are replaced by the moon. Also, there is a polygram, which consists of a sign of the full moon and a crescent drawn on it. In the same scheme of painting we have a picture of the moon in the first quarter and the sign of the oblique cross in the middle. In the upper tiers of paintings of biconical utensils without handles, the moon signs are replaced by signs of plants both next to and without triangles: animals, triangles, oblique crosses. On one crater in the upper tier, a polygram is drawn in the form of two signs - an animal and a moon. Below them in the lower tier is a wide ribbon filled with horizontal lenticular ovals. In one case, on the crater, in the lower tier of the painting, in the oval are drawn three signs of plants on the moon.



In the III phase of development of the Tomashivka group the semantic field of the sign in the form of a crescent moon can be outlined as follows: **full moon** (7 graphemes from Taliانki, 9 - from Maidanetske) - **grain** (3 graphemes from Taliانki, 3 - from Maidanetske) - **plants** (1 grapheme from Taliانki, 2 - from Maidanetske) - **animal** (1 grapheme from Maidanetske) - **water** (1 grapheme from Taliانki, 2 - from Maidanetske) - **"chest"** of anthropomorphic vessels (6 graphemes from Taliانki) - **"faces"** of anthropomorphic vessels.

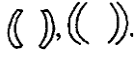

On the sign systems of the Chechelnyk group in one case, the signs in the form of crescents of the moon flank the medallion with a cross inside (Cherkasiv Sad II): . In the second, they surround the medallions with four hemispheres, two of which (upper and lower) are painted black, and between them are several lines (Chechelnyk): . In the sign systems of the Chechelnyk group, the semantic field of the sign is very narrow and probably consists only of the sign of the full moon (3 graphemes).



On craters, biconical and pear-shaped vessels from the Bernashivka settlement, single and double moons were depicted as interceptions on S-shaped arcs. Of particular interest was the moon in the first quarter, when it only appeared in the sky in the form of a narrow crescent. We have a total of 42 individual drawings crescents:  and 14 double moons in the first quarter: . Grapheme in the form of the moon in the last quarter much less - 4 single:  and two double images of the moon: . In one case, the signs of the moon in the first and last quarters are drawn inside the S-shaped arc: . Otherwise, in this area are drawn horizontal crescents of the moon along with triple vertical lines: . In some cases, signs in the form of a crescent moon are replaced by signs in the form of a full moon: . The moon sign inside the S-shaped sign of the snake is drawn on a biconical vessel:





 Also, above the medallion with black hemispheres in the second tiers of the same vessel also depicts the moon sign. Single and double lunar icons are located in the centers of bowls painted with torn festoons: . Here they are replaced on the signs-icons of water surrounded by eight lunar sickles:  on the red circle; groups of two and five dashes: . Signs on the crescents of the moon. Signs-icons of the moon were depicted on the free fields of bowls, painted with crosses.





Twice in these schemes in the centers next to the drawings of the crescents of the moon, there is an image of a black circle - a sign of the full and, which are usually drawn at the ends of festoons, in one case a change-moon: .



The crescents of the moon flanked the empty circles: once on the "Tangentenkreisband" scheme of pear-shaped vessels: , and the second - in the center of the lid. On a fragment of another lid, the sign-icon of the moon is drawn next to an empty medallion: . On another lid, painted double ovals, in their middle are two signs of the moon: .





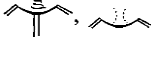

On bowls, painted arcs that go one after another, the moon signs flank the wavy ribbon: ; depicted in the center or flank it. On the cups, the moon signs were drawn in metopes (2 graphemes). Very rarely, the moon signs were placed under the areas of the cups (we have two graphemes). On amphorae painted with "front" paintings themselves, the signs in the form of crescents of the moon in one case flank ovals around the handles: . In another - double moon signs are depicted with horns down under the ovals: . Also, in the ovals under the handles often applied

negative moon signs: , in these areas instead of months depicted double black circles:  and a wavy line: .

On amphorae, painted with "owl faces", next to the "eyes" - medallions with black hemispheres, in the middle of them are signs-icons of the moon: . In one case, instead of medallions "eyes" are drawn signs-icons of the moon: . In another, next to the "eye" is drawn an animal: . Interestingly, the moon signs were located above the "eyes", while the animal was depicted below them. Under the handles of the amphorae, painted with "owl faces", depicted horizontal moon signs with horns up (three graphemes): .

One of them is combined with a sign in the form of a ladder: , and the other is combined with a vertical sign of water, which is depicted above the handle: . Moon signs were also drawn in the second tiers of amphorae on the "Tangentenkreisband" scheme. In one case, they are depicted here next to the water sign: . On the same tier, there is an interesting polygram in the form of an image of a bovid with a crescent moon instead of horns: . As has been repeatedly noted, the paradigmatic series of signs drawn in the second tier of this scheme includes 6 drawings of animals, 4 drawings of the moon, 2 graphemes in the form of lenticular ovals, one graph of a ladder, and 10 symbolic signs.



On a bowl with Petreny, which is painted with a diagram in the form of the number "8", the moon signs flank the sign-icon of water in large ovals: . In the small ovals of these bowls, the moon signs are also combined with the water sign. One of these graphs shows three vertical lines in the middle of the lunar sign. The signs of the painting in the form of an "owl's face" under the handles drew the moon signs: . Moon signs were also depicted near the handles of amphorae with "face" paintings: .



In the sign system of the settlement of Lipchany, the moon signs were placed on a cup-shaped vessel: . Another cup depicts triple horizontal lunar figures with the following inscriptions: . On the amphorae painted with oblique crosses, the icons of the moon are depicted between them: . On the crater, which is painted in the form of S-shaped arcs, double moon signs in the first quarter are drawn as interceptions: . One moon sign is depicted on a "belly" of an anthropomorphic figure: . In the scheme of painting "owl face," moon sickles are drawn in the "eyes of the faces": .

lunar crescents are drawn in “Eyes of the faces”: Moon signs in the first quarter surround the medallions with black hemispheres in their middle: 

In the sign system of the settlement, Stina IV attracts attention with a relatively large number of cases of combinations or arrangements near the signs-icons of the moon and signs-symbols in the form of crosses in a circle. Thus, on the bowl, which is painted with a diagram in the form of the number “8”, in large ovals are drawn the signs of water next to the sign of the moon: , and in small ovals are crosses in circles. Otherwise, the moon is outlined with black dots next to the red crosses in the circles

depicted on the biconical vessel painted with the “Tangentenkreisband” scheme: . Another already mentioned polygram, which consists of the union of the sign of the moon and the cross in the



medallion, is depicted in the center of the “belly” of the anthropomorphic  vessel:  on



an amphora with a “front” painting: . Lunar graphemes on one biconical vessel are depicted in combination with vertically arranged horizontal small dashes: .

Double moon signs were depicted on cups in metopes: , where they changed to signs in the form of animals and water.

Analysis of the painted vessels of the Petreny group and the approximate sign system Stina IV allows us to reconstruct the semantic field of the sign-icon “moon” as follows: **full moon** (9 graphemes from Bernashivka, 1 - from Lipchany) - **water** (8 graphemes from Bernashivka, 3 - from Petreny, 1 - from Stina IV) - **snake** (1 grapheme from Bernashivka) - **animal** (1 grapheme from Bernashivka, 1 - from Lipchany) - **“eyes”** of anthropomorphic ware (4 graphemes from Bernashivka, 1 - from Lipchany) - **ladder** (1 grapheme from Bernashivka). Also, the moon signs are combined with signs in the form of a cross in a **circle** (3 graphemes from Bernashivka, 1 - from Lipchany, 3 - from Stina IV).



On the painted utensils from the settlement of Konovka the moon signs are located under the handles, in

the second tiers of amphora paintings, near the handles: . Also, near the pen shows a polygram, which consists of a horizontal negative sign in the form of a crescent moon, a circle around the handle  and a horizontal lenticular oval above it. The double signs of the moon in the first quarter



depicts an intercept on an S-shaped arc: . We also have two signs in the form of arcs, which in one case ended with the signs of the full moon: , and in the second case with dashes: .

In the sign systems of the Shipintsi group, the signs-icons of the moon were depicted in the second tier of amphorae (Shipintsi B): . They were part of a large paradigmatic series, where, among others, there were signs-icons of animals, ladders, plants, water. On the dishes from Bilche







Zolote Park III the signs of the moon with black circles were drawn on amphorae: . On the dishes from Bilche Zolote Verteba I, the moon signs-icons are painted on the bowl where they flank water





sign: , or depicted next to the signs of the cross and animals: . But most often they are placed in the second tier of the painting of amphorae. Here they are drawn next to the sign of the snake - water: .

The semantic field of the **moon** sign in the sign system of the Shipintsi group has only a connection with the **full moon**. If you add here the signs that replace it, it takes the following form: **full moon - water - snake - animals - plant - ladder - grain**.



Valea Lupului II has a very similar context in the sign system. On one bowl, 13 moon-like signs, outlined with white dots, were found in free fields that formed triple-crosses: . A vessel with a high cylindrical neck in metopes depicts two red animals standing opposite each other surrounded by red dots. Between the two of them at the top is drawn the crescent moon: . On the anthropomorphic vessel, the red signs of the moon flank the double vertical signs of the serpent - water: .

The semantic field of the **lunar sign** in the sign system of Valea Lupului II is connected with the sign of the **snake - water, animal, and cross**.

On the dishes from the settlement of Varvarivka XV double red lunar crescents are depicted in small ovals of a bowl, which is painted with a diagram in the form of the number "8": . Also, the signs-icons of the moon painted in the second tiers of paintings of amphorae: . Lunar graphemes are included here in the paradigmatic line in the form of a snake - water and plants. In one case, red lunar signs are depicted next to four vertical ribbons filled with oblique crosses:  has the following form: . "eyes" and across (1 grapheme). They are replaced by snake signs - water and plants. On the bowl, which is painted with a diagram in the form of the number "8" from the settlement of Bădragii Vechi, red moons are drawn next to the water sign in large ovals: . On another bowl in these areas are negative moons snake - water: . On the crater, above the negative sickles, there are double signs of the snake - water: . On the amphora with the "owl's face" red moon signs flank two medallions with crosses and signs of the snake-water above them.

On a similar vessel from another settlement of this time - Hancăuți and "eyes" painted surrounded by moon signs: . Once instead of "eyes" red moons were drawn: . Such are the contexts of the lunar sign on the paintings from the settlement of Konovka (site 1,2). The red moons flank the red spiral in the "owl face" scheme: . Moon sickles were also painted in these areas: .



On the painted ware of settlements of the Bădragii type the semantic field of a sign in the form of a sickle of the moon looks so: **snake - water** (4 graphemes from Bădragii Vechi, 1 - from Hancăuți I) - **"eyes"** of anthropomorphic ware (1 grapheme from Bădragii Vechi, 4 - from Hancăuți 1, 2 - from Konovka pl. 1, 2) - **cross** (1 grapheme from Bădragii Vechi, 1 - from Hancăuți I).

The lunar signs in the sign system of the Koshylivtsi Oboz settlement were placed on bowls painted with lenticular ovals in the middle; one bowl with a cross at the ends of the ribbons has crescent moons. Also, the red signs of the moon are painted on a bowl, which is painted with a wide border with triangles drawn on its edge. Another bowl for four moons is surrounded by two large moon-shaped figures: . On a fragment of one amphora, the moon sign in the first quarter is located next to the icon: . In the sign system of Koshylivtsi Oboz, the semantic field of the crescent moon includes the signs of a plant (1 grapheme) and across (1 grapheme).



Vertical rows of dashes



In the sign systems of stage BII, the semantic field of this sign cannot be studied. Only in the east of the oikumene, from the second phase of the Tomashivka group, it is depicted next to the iconic signs.



In one vessel from the settlement of Sushkivka, vertical rows of dashes flank double horizontal crescents of the moon: . On a cut-spherical bowl from Chicherkozivka, double rows of dashes form a swastika-like composition with the sign of the full moon in the middle. The cup rows of dashes are depicted in



metopes between the crescents of the moon: . On bowls painted with arcs that go into each other and end with lunar sickles, the rows of dashes are included in a paradigmatic series of signs, including images of ladders, water, grain (Talianki). On one of these bowls, there are signs of plants and rows of dashes next to each other: . On another bowl dashes form a swastika-like composition with a central



grapheme in the form of a full moon: . Here are already familiar signs of grain, ladders, signs of plants, and signs-symbols in the form of a "comb", an oblique cross, a quadrangle, and a vertical ribbon, which are filled with a grid. In addition to "triglyphs", vertical rows of lines were drawn between them (in metopes). Polygrams were kept on the fragments of the utensils, on which you can also see the

connection of grain signs with vertical rows of dashes:  and a ladder: . But the brightest connections of this sign with the drawings of the crescents of the moon: . They flanked the moon sign under the handle of the crater and painted it between the crescents on an anthropomorphic vessel:



, they were located under the moon sign with amphora handles with a "front" painting: . Inside a bowl from Maidanetske on arches that go one after the other and end with crescents of the moon. In





other cases, here, along with the signs-symbols, painted signs-icons:  ladders:  and plants. On another bowl, the arcs of which end in black circles - the signs of the full moon, next to them are rows of dashes: . In one bowl, the dashes together with the signs of plants form two crosses. In the middle

of this composition is a sign of the full moon: . On the second bowl dashes it is important to note, forms a swastika-like composition with a sign of the full moon in the middle: . It is important to note that in other cases, similar swastika-like compositions are formed by wavy lines or ribbons, ie watermarks:





, . From the settlement of Maidanetske, we have bowls, which depict several cross-shaped



stripes: . On the cups, several vertical lines were drawn in "trig-bodices", where it is included in several signs that almost completely coincide with the Talianki. Between the metopes of the cups, rows of horizontal lines are replaced by signs of plants, animals, and ladders. In a number of signs of the second tier of a list of biconical ware with handles, it is possible to see rows of lines which are replaced here by a wide enough set of signs: single, double, and triple plants with triangles nearby and without them; triangles without plants; double and triple lenticular ovals; "Stars"; "Combs"; ladder. If we take into account the graphemes that are drawn below them, then complex polygrams are formed. In one case,



the lower lenticular oval is a grain sign flanked by 'combs': , in the second - on the handle in the lower tier shows a group of horizontal lines with lines that diverge in two directions: 

In the sign system of Tomashivka, vertical rows of lines on the bowls were included in arcs that go behind each other: . In one case, next to several lines drawn crescents: they are replaced by signs in the form of a ladder: . In one bowl, the signs form swastika-like composition around the central sign of the full moon . In the "triglyphs" of their cups, as in other sign systems of the Tomashivka group, they replace the signs of plants, grains, and a vertical ribbon filled with a grid. On the amphora with a "front" painting near the handles, there are polygrams, which consist of a group of horizontal lines drawn on the handle and double horizontal crescents of the moon with rows of lines between them: .

The analysis of sign systems of settlements of the Tomashiv group allows to reconstruct of the semantic field of the sign in the form of vertical rows of lines (or one row): **crescents of the moon** (1 grapheme from Sushkivka, 1 - from Chicherkozivka, 4 - from Talianki, 2 - from Tomashivka) - **grain** (1 grapheme from Talianki, 2 - from Maidanetske) - **ladder** (1 grapheme from Talianki). Observing the replacements adds a sign of **water** here.

On the dishes from the settlements of the Chechelnyk group, vertical rows of lines were depicted in the middle of medallions with hemispheres:  and quadrilaterals: . These signs are included in the paradigmatic series, which were drawn in the medallions of the scheme "Tangentenkreisband" (Cherkasiv Sad II), where they are replaced by a sign in the form of a ladder: . In one of these medallions, there is a polygram, which consists of a vertical row of lines and crescents of the moon at the bottom: .



On two-tiered ware, the vertical row of lines in the second tier of the painting is replaced by the signs of the moon and the animal. On one fragment of the vessel, we have a picture of several lines next to the image of a ladder: . On a bowl from the settlement of Chechelnyk, which is painted with a diagram in the form of the number "8", small ovals depict a polygram consisting of a negative pattern of the moon in the first quarter, a medallion with hemispheres and a vertical row of dashes in its center - the sign of the full moon. images of the month in the last quarter: . Otherwise, in the middle of the medallion painted sign water: .

On another two-tiered vessel, medallions with ovals and rows of vertical lines inside were depicted in the lower tier. In the upper-tier on one such vessel is a picture of an animal in a medallion: . On a biconical vessel with anthropomorphic features - two stickings - "chest", two groups of lines depart from them down: .

Vertical lines on the biconical vessel from Stina IV are depicted under the sign in the form of a crescent moon: . Vertical rows of lines are also on the vessel, which has bright Chechelnyk features: on the cup and biconical vessel.

In Chechelnyk sign systems, the semantic field of this sign is as follows: **ladder** (1 grapheme from Cherkasiv Sad II, 1 - from Chechelnyk) - **the crescent moon** (1 grapheme from Cherkasiv Sad II and I -

from Stina IV) - **full moon** (1 grapheme from Chechelnyk) - sticking - "**chest**" of anthropomorphic vessels (1 grapheme from Chechelnyk).

On a biconical vessel with Petreny in the second tier of the painting a group of vertical lines is flanked by two figures of animals:  an animal with horns-moon, moon, ladder. On ware from the settlement of Lipchany rows of vertical lines drawn on crater crowns. Also, the double rows of lines are located next to the stickers - "chest" of the anthropomorphic vessel: 

In the sign systems of the Petreny group, the vertical rows of lines have the following semantic field: animals (1 grapheme from Petreny) - "chest" of anthropomorphic vessels (1 grapheme from Lipchany).



The dishes from Valea Lupului II the group of lines is depicted next to the wavy signs of the snake  - water and moon on a cut-spherical bowl inside the ribbons that separate the ornamental tier on two metopes.







On the vessels of the settlement of Valea Lupului II, the semantic field of lines is outlined as follows: **snake-water** (2 graphemes) - **the crescent moon** (1 grapheme).

On the painted utensils of later settlements, we have a small number of signs in the form of vertical lines without connections with the iconic signs, which does not allow us to determine their semantic fields. As already mentioned, the following five semantic markers stand out hypothetically. In their pure form, like simple graphemes on a painted vessel of the Rakovets group, they are still unknown but are here an integral part of certain polygrams.

A medallion filled with papers





The dishes from the settlements of Nemyrivske and Stanislavka in the centers of this sign depicted a lenticular oval: 

On the ceramics from Nezvysko III in medallions with black hemispheres painted groups of vertical red or black lines: . In one case, there was a polygram with a sign of water inside: .

In the centers of similar medallions on ware from Volodymyrivka, except for a water sign: , on handles depicting the signs of the full moon lenticular black oval - a sign of grain: , vertical lines the lines at the ends end with the signs of the full moon: , double signs  of the full moon above the handle and below it: . In one case, vertical . Also, the handles were placed in groups of horizontal lines .

The semantic field of this sign in the sign system of Volodymyrivka consists of the signs of the full moon (4 graphemes) - grain (1 grapheme) - water (1 grapheme).

Medallions with semicircles were rarely used on the dishes of the settlements of the Nebelivka and especially Tomashivka groups, as a rule, without signs inside. Only on a vessel from Sushkivka in a medallion with a semi-shaft drawn lenticular oval on the handle: 







On the vessel from Talne II, we have a medallion with a vertical water sign in the center: . Unlike the Tomashivka group, medallions were often used in the paintings of the Chechelnyk group. Inside them were signs in the form of ladders: , dashes with the moon:  and without: . In one case, next

to the medallion is an image of an animal (Cherkasiv Sad II): 

As already mentioned, on the vessel from the settlement of Chechelnyk we have a medallion flanked by signs in the form of crescents of the moon, which allows us to consider it as a sign of the full moon. In the center of one medallion water sign-icon is located: 



In contrast to Tomashivka sign systems, where this sign was rarely used, in Chechelnyk its semantic field is defined as follows: **ladder** (2 graphemes from Cherkasiv Sad II, 2 - from Chechelnyk) - **the crescent moon** (1 grapheme from Cherkasiv Sad II, 3 - from Chechelnyk) - **full moon** (1 grapheme from Chechelnyk).

In the iconic systems of the Petreny group, medallions with two and four ovals also belong to nearby most commonly used characters. Sometimes crosses were painted inside them (Bernashivka):  with

them had signs-icons of the moon Bernashivka: , ,  Lipchany:  depicted as "eyes" of anthropomorphic creatures in the schemes of painting "owl face"; on the paintings "facial motif" between the masks (Bernashivka): ; on the side of the anthropomorphic vessel (Lipchany): 



In the sign systems of the Petreny group medallions with two, four, and, less often, more ovals belong to the most frequently used signs, their semantic field is as follows: **crescent moon** (4 graphemes from Bernashivka) - **"eyes"** of anthropomorphic vessels (2 graphemes from Bernashivka, 1 - from Stina IV).

Medallions with black hemispheres and lenticular ovals in the centers, on the vessel Shipintsi B in

five cases were depicted next to animal signs: . Only once next to the picture of the animal is a medallion with a ribbon in the center: .

The medallions on the paintings of this settlement were filled with straight vertical ribbons (16 graphemes) or single (9 graphemes), double (2 graphemes), and triple lenticular ovals (2 graphemes). Inside most of them, as already mentioned, are negative signs of water.

The semantic field of medallions with semi-ovals in the Shipintsi subgroup has a different form: **water-grain** (11 graphemes) - **animals** (5 graphemes) (all from Shipintsi B). On ware from Bădragii Vechi and

Hancăuți, I in medallions with ovals sometimes represented lines:  and oblique , as the previous analysis showed - the signs of the full moon. Above the medal, we sometimes drew signs of a snake - water: .



In the sign systems of settlements of the Bădragii type the semantic field of the **medallion with hemispheres** can be reconstructed as follows: **full moon** (3 graphemes from Bădragii Vechi, 2 - from Hancăuți I) - **water-snake** (1 grapheme from Bădragii Vechi, 2 - from Hancăuți I).

Thus, the analysis of semantic fields showed that in most sign systems the studied grapheme is closely related to the moon, so we can agree with its interpretation by Rybakov as a sign of the moon, or rather, some of its states. Also, medallions with black or empty hemispheres were often the location of a certain circle of signs, i.e. they were the organizing elements in the schemes of painted utensils.

Straight vertical lines and stripes.

Among the signs on the utensils from the early settlements of the BII stage, the straight line is connected

by two black circles-signs of the full moon (Florești V): . The authors would like to remind that two black circles are flanked by black or red lenticular ovals and inclined ribbons. This may indicate a close relationship between these characters. On the dishes from Nezvysko III straight lines were drawn on the

handles: , where they were replaced by lenticular ovals: , and on cups: , where they divided the ornamental field into metopes. On amphorae with "front" painting themselves from Volodymyrivka

straight lines on handles: , were replaced by a lenticular oval or by a black circle. On the cups, in quadrangular metopes, only straight lines and vertical lines were depicted, which combined two black

hemispheres - "humps". It can be assumed that these two signs change each other  combine here



two black hemispheres - "humps": . On the craters from the settlement of Pischana, straight lines

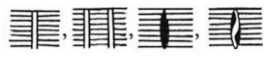

were depicted in quadrangles on crowns are replaced in this area by lenticular ovals: . A similar replacement can be observed in other (upper) areas of the painting of amphorae, where these signs are

painted shafts in curbs filled with horizontal lines: .



On the handle of the vessel from Kolodyste a straight vertical line is flanked by black circles: . It's clear evidence that certain blocks of polygrams were transmitted in time and space (as we remember, the first such polygram occurred on the dishes from Florești V).

At the BII stage, the semantic field of vertical lines and ribbons can be reconstructed as follows: **full moon-grain**. In the paintings of utensils from the settlements of the second phase of the Tomashivka group, vertical lines were drawn in complex polygrams, where they were located at the top of the moon-

shaped signs (Sushkivka: , Dobrovody: ). Also, there are traditions of earlier sign systems of stage B II - replacement of vertical lines on the handles with a lenticular oval and vertical lines on the cup. In the sign systems of the settlements of the III and IV phases of the Tomashivka group, vertical

lines and ribbons are flanked by the signs of the full moon (Taliانki: , Maidanetske: ,

Talne II: ). Except for this, the signs of the full moon flank lenticular ovals and vertical bands.



Sometimes they were located at the ends of vertical strips (Taliانki: , Maidanetske: , Tomashivka: .

Vertical lines were also drawn inside the crescents of the moon (Taliانki: , Maidanetske:

, Tomashivka: ). On a biconical vessel from the settlement of Taliانki above

the vertical tape applied to the handle, the sign of the plant is drawn as follows: . Among the painted utensils from Maidanetske in the second tier. The writing of the biconical vessel next to the triangles,

where the plants were usually drawn, is a vertical ribbon, which seems to indicate their close connection:



. Direct lines were drawn inside the arcs, which go one after another, on the bowls: .



Here they are replaced by a large number of characters, among which: vertical lines, ladder, wavy ribbons, grain sign, oblique crosses, plants, vertical lines, and moons (Tomashivka).

In later Tomashivka settlements, their semantic field has the following form: **a full moon** (5 graphemes from Talianki, 4 - from Maidanetske, 1 - from Tomashivka) - **a plant** (2 graphemes from Talianki). Ladder and grain signs add to the paradigmatic relationship of the sign.

In the sign systems of the Chechelnyk group, vertical lines were depicted inside the medallions, where



they combined black hemispheres - "humps": . In these areas, they were replaced by vertical lines:

 and ladders: . It becomes evident, that replacing vertical lines with dashes here is similar to replacing cups from Volodymyrivka, and their replacement by ladders - by later sign systems of the

Tomashivka group. On dishes from the settlement, Konovka vertical lines   were replaced by



lenticular ovals. Further, they divided into two halves large medallions:  and lenticular ovals: .

Straight vertical ribbons replaced the lenticular ovals and inside the medallions on the dishes with

Shipintsi B:  . They also divided the ornamental field of the cups into two zones: . In the sign

system of the Shipintsi group, straight lines or ribbons were replaced by lenticular ovals - signs of grain. They are also divided into two halves large ovals and "grain" signs. In the sign systems of the Petreny

group, vertical ribbons were depicted on S-shaped arcs, once - next to the crescents of the moon (Bernashivka: , they were placed inside the medallions, both filled with semi-ovals and without them:

  . In the cups, they divided the paintings into two metopes:  .

Also, they were drawn together with the moon signs on the "owl face" schemes (Bernashivka, Petreny: ). In the medallions,

on the bowl painted with the figure "8", the vertical line was replaced by a water sign. Two animals flank the vertical ribbon on the cup). (Petreny: ). At the ends of the vertical stripes were black circles -



signs of the complete month (Petreny: .



In the Petreny group, the semantic fields of the vertical ribbon (line) have the following form: **crescent moon** (4 graphemes from Bernashivka, 2 - from Petreny) - **full moon** (2 graphemes from Petreny) - **water** (1 grapheme from Bernashivka) - **ladder** (1 grapheme from Bernashivka) - **an animal** (1 grapheme from Petreny).

On the painted ware from settlements of the Bădragii type straight tapes are flanked by pairs of signs of

a snake - water (Bădragii Vechi: ). Sometimes they were painted in medallions (Bădragii Vechi:

 ). In the iconic system of settlement Hancăuți I, along with vertical lines drew triple signs of a

snake-water, double and triple W-shaped signs are equivalents of signs of a snake-water:   .



In some cases, they flanked vertical lines: . The straight lines were placed in the tangents of the "Tangentenkreisband" scheme along with large signs of snakes - water: , as well as with animals and plants.

In the sign systems of settlements of the Bădragii type the vertical line has the following semantic field: **snake-water** (2 graphemes from Bădragii Vechi, 9 - from Hancăuți I), **animals** (2 graphemes from Hancăuți I), **plant** (1 grapheme from Hancăuți I).

Vertical ribbons on the dishes from Târgu Ocna-Podei divide the ornamental zones into metopes and are

flanked by black circles: . In paintings from Zhvanets vertical lines in most cases are

flanked by signs of a snake - water: , (39 graphemes),  red or black circles with and without dashes

- signs of the sun (?) or the full moon (?):  (3 graphemes), birds:  (1 grapheme), triple dashes:



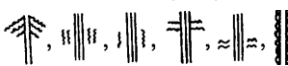

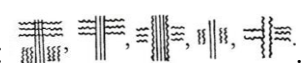





 (1 grapheme), which determines the semantic field of this sign. Straight ribbons in the sign systems of the Ofatinți, Usatove, and Mayaky cemeteries, as well as Usatove-type burials, are flanked by signs of

a snake - water: . The same can be observed on the painted ware from the





monuments of the Gordinești type: .

Functionally straight lines or ribbons organize the ornamental space. They are used to create static compositions. Thus, in the BI and early stages of CI-γI, the signs in the form of vertical lines or ribbons were closely related to the moon and the grain. At the end of stage CI-γI and in stage CII-γII, certain changes took place in the use of this sign and it began to be associated with the signs of the snake-water.

Oblique lines or ribbons





On the painted ware from early settlements of a stage of BII, the inclined tapes are flanked by black circles - signs of the full moon (Rakovets, Nemyrivske, Stanislavka ). A similar environment is often (21 times) located on the S-shaped arcs drawn on the dishes from Volodymyrivka:  much less often (4 times) they combine black hemispheres:  or flanked them  (1 grapheme). Diagonal ribbons combine the signs of the full moon   (2 graphemes from Volodymyrivka), and in one medallion they unite black circles and are flanked by them:  (Volodymyrivka). Another grapheme shows the union of black hemispheres diagonal ribbon and full moon signs that flank it: . In one case, next to the inclined ribbon is a lenticular oval filled with a negative sign of water: . A small diagonal ribbon departs from the center of the crescent moon:  (Volodymyrivka).

In the sign systems of the settlements of the BII stage, the semantic field of this sign is defined as follows: **full moon** (26 graphemes) - **the crescent moon** (1 grapheme) - **water** (1 grapheme).



The signs of the full moon are the only grapheme located next to the diagonal ribbons in the paintings of dishes of other settlements of the BII stage, as well as settlements of the II phase of the Tomashivka group, all phases of the Chechelnyk and Petreny groups (except the Shipintsi group). On the painted ware of the III phase scrolling of the Tomashivka group, diagonal lines in some cases are combined with signs in the form of a crescent moon (Taliانki:    , Maidanetske: ). Diagonal strips are located above and below the groups of horizontal lines depicted on the handles biconical vessel.

Above this polygram is a plant (Maidanetske: ).

The semantic field of the diagonal ribbon in the settlements of the III phase of the Tomashivka group has the following form: **crescent moon** (8 graphemes from Taliانki) - **full moon** (2 graphemes from Maidanetske) - **plants** (1 grapheme from Maidanetske).

Among the ornaments of the utensils from Shipintsi B, next to the inclined ribbons, there are images of animals: . The same images are on the utensils from the later Bilche Zolote Verteba I: . On the dishes from Bădragii Vechi diagonal lines in some cases ended in black circles - signs of the full moon:  . In one case, next to such graphemes are icons snakes - water: .

The semantic field of diagonal lines in the sign system of the Bădragii Vechi can be reconstructed as follows: **full moon** (3 graphemes) - **snake-water** (1 grapheme).

Among the painted dishes from Koshylivtsi Oboz, we have a polygram, which depicts a plant surrounded by oblique red lines: . On another vessel next to the oblique red ribbon drawn red signs of a **snake-water**: .

In the sign system of the settlement Koshylivtsi Oboz, it has the form: **plant** (1 grapheme) - **snake-water** (1 grapheme).

The sign of the snake-water next to the diagonal ribbons is on the paintings of dishes from Târgu Ocna

Podei: .

On the vessel from the settlement of Zhvanets, the diagonal ribbon is depicted in a large lenticular oval, next to which in the same ovals are two birds flanking a vertical ribbon with lines. The second oval depicts



an oblique cross: .

It is impossible to determine the semantic fields of diagonal ribbons in the sign systems of the Ofatinți and Usatove cemeteries, as well as vessels from Usatove-type burials. Only in one case on the outside of the bowl from the Ofatinți cemetery next to the oblique ribbon are depicted signs of a snake-water













. Next to the diagonal ribbons occurred in the sign system of the Târgu Ocna-Podei and the later Ofatinți cemetery. Thus, the semantic fields of diagonal lines or ribbons are very similar to the previous ones, characteristic of signs in the form of vertical lines and ribbons, which may indicate their very close nature. They are also very closely associated with the moon from the beginning (stages BI beginning and middle of CI-γI), and then, at the stage of CII-γII, with the sign of the snake-water.





Quadrilaterals



This sign forms a place for other signs. On utensils from early settlements, YOU depicted quadrilaterals on amphorae painted with "front" schemes (Nemyrivske) and a cup. They were usually filled with vertical lines:  lenticular oval: , once here was depicted red. On the cup, in this area, were drawn two black circles, located at the top and bottom:  (Stanislavka).





On the painted ware from Nszviska III quadrilaterals are on craters, amphorae, and lids. On one crater in the upper and lower parts of the quadrangle are drawn hemispheres, the field between them is filled with red vertical lines: .

On the dishes from Voroshylivka, quadrangles were drawn on craters and cups. Inside, the craters depicted black semi-hills, connected by vertical lines: . Also, the quadrilaterals were flanked by vertical lines, leaving the central field empty or filled with groups of vertical lines only in the middle. On cups, painted and lenticular oval: . In Volodymyrivka, quadrilaterals were used on cups, crater crowns, amphorae. In these areas, they were filled with vertical lines or has a lenticular oval: .

On the cups, in the centers of the quadrilaterals, vertical lines  were often drawn, which either connected the black hemispheres - "humps", or were depicted without them. In one of them, under the lower black "hump", there was a ladder surrounded by vertical lines: . On the dishes from **Pischana**, quadrilaterals were painted on the crowns of craters, amphorae, and cups. In their upper and lower parts often depicts double vertical lines that filled the quadrilateral: . Lenticular ovals were depicted as black  semi-ovals, and between them were lenticular ovals:  also without black hemispheres - "humps": . On the cup, at the bottom of the quadrangle, are drawn vertical lines - signs of grass: .

On utensils from Kolodyste quadrilaterals are on cups and a jug with the handle. The cup, in the center of the quadrilateral, shows vertical lines and a group of oblique lines: . Also, we have an empty quadrangle flanked by ladder signs:  and a quadrangle on the jug, which is filled with vertical lines: . The quadrilaterals on the cups from Sushkivka show groups of vertical ribbons, vertical lines that connect two black hemispheres: , as well as a vertical ribbon filled with a grid: .

On one hemisphere- "hump" we have the image of an oblique ribbon filled with a grid: 3 to one of the quadrilaterals on the cup are drawn double black circles - signs of the full moon: . A quadrilateral filled with vertical lines intersected by a group of oblique lines is located on one biconical vessel: . Another quadrangle with an image in the center of the ladder surrounded by vertical lines flanked by

ladders, drawn on another biconical vessel: . On the cups from the settlement of Chicherkozivka the  quadrilaterals are filled with double-crosses:  oblique lines: , dashes: 

On a biconical vessel with four-, vertical lines: the corners are filled with vertical lines. In the quadrilaterals on the cups / from Dobrovody are drawn: a ladder connecting two black hemispheres-Bags “:  a plant





on the lower “hump”: . In the quadrilaterals on the biconical vessel were drawn vertical lines that



intersect obliquely:  with grid:  and vertical lines flanked by ribbons. We also have a quadrangle

with two black hemispheres - “humps”, which are connected by vertical lines: 

In the ceramics of the third phase of the Tomashivka group, the use of quadrilaterals is most differentiated. Empty or, more often, filled with black hemispheres - “humps” quadrilaterals, between which were the signs of plants, grains, vertical lines, a small quadrilateral filled with a grid, “comb”, ladders, are drawn only on cups. In one case, it depicts an oblique cross - perhaps a tribute to the traditions of earlier times. The quadrangles on the biconical vessel filled in vertical and oblique lines, sometimes merging into blocks. Also, oblique crosses were painted here. Sometimes there are quadrilaterals without images.

The cups from the settlements of Maidanetske and Talianki in quadrangles housed the already mentioned signs. Oblique crosses were often painted in quadrangles on biconical utensils from

Maidanetske: , , ,  and once - a straight cross: . Also, there are single sign of a

plant: , and plants:  also a black circle:  and some fantastic animal: . Rows of

dashes and vertical lines were often drawn on the dishes of the Chechelny group, in quadrangles with

black hemispheres-‘Bags’ and without them. Very rarely they were flanked by ladders:  (Cherkasiv

Sad II). Inside they also depicted the signs of the moon:  (Cherkasiv Sad II).



On the dishes from the settlement of Chechelnyk, similar quadrilaterals were also painted on cups and biconical dishes. In the dishes from Konovka, quadrilaterals were mostly depicted on craters painted with four-rayed stars. Inside the quadrilaterals at the bottom and top are black hemispheres “Humps”

connected by lenticular ovals: , vertical tape:  and lines: , tape, filled with grids:  or a

series of triangles: . In two cases, the quadrilaterals are located on a pear-shaped dish.

On the painted ware of the Petreny group, the quadrilaterals are on the cups and biconical ware. On one cup, which is painted with a “front” scheme, in the center of the quadrangle, there are vertical lines that

connect two black circles drawn at the top and bottom:  (Petreny). On biconical vessels, quadrilaterals were often filled with vertical lines, depicted either only in the middle or applied over the

entire area. The top of one such quadrilateral is drawn black double lenticular ovals with lines:  (Petreny). Inside another is a ladder:  (Petreny).

In most cases, the quadrilaterals on the dishes from the Bernashivka settlement are located on the second tier of the amphora painting. Only in one case, they are drawn in the first tier. On the anthropomorphic vessel in the area of the "chest" stickers, we have a slightly deformed sign of a quadrilateral, which consists of from the image of black hemispheres- "humps" above and below and

curved inward sidelines:  The signs are on the Chechelnyk "import" found in the settlement of

Lipchany:  as well as on cups with a settlement with a strong element of Chechelnyk traditions –

Stina IV. Here, inside them, are drawn plants: , vertical lines connecting black hemispheres, vertical



dashes, and lines: . In the ornamentation of Shipintsi B vessels, quadrilaterals were applied to craters painted with four-rayed stars and a horizontal lenticular oval, as well as to biconical vessels. They show

vertical red lines that intersect with small black lines: .

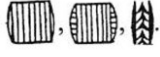

On the utensils from the settlement of Koshylivtsi Oboz, the quadrilaterals divide the ornamental fields into metopes. Quadrilaterals are also found on amphorae from Usatove-type burials and similar vessels from the Gordinești settlements. They are filled here in most cases with signs of a snake - water and once with an oblique cross surrounded by signs of a snake-water. This sign forms a place for other signs. One of the important functions of quadrilaterals on painted utensils was to create static compositions. They divided the ornamental field, usually into two or four zones, thus creating, if you look at the dishes from above, cross-shaped compositions. If they were connected by tangents, then as a result, dynamic swastikas were added to the static compositions, and the whole composition took the form of a combination of a cross (static composition) and a swastika (dynamic composition).

A vertical strip flanked by two vertical hemispheres

This sign is present on the painted dishes from Florești V: . Through after a certain period at the end of stage BII on the painted vessels of the second phase of the Nebelivka group from Kolodyste.



The ribbons of these signs are filled with vertical lines and a vertical row of triangles: . On the utensils from the Konovka settlement, the vertical wide ribbons of these signs are either empty or filled with vertical black and red lines: .

In the east of the Trypillia-Cucuteni oikumene, similar signs did not seem to be used on the painted utensils of the Tomashivka group. Among the painted dishes of the Chechelnyk and Petreny groups of the CI-γI stage, signs in the form of vertical ribbons flanked by vertical hemispheres are rare. In the vessels of the early phases of the existence of these groups, the middle of the signs are empty or filled with vertical lines. Triangles appear inside the vertical stripes on the vessels of the last phases of the Petreny

and Chechelnyk groups:  (Lipchany) and a wavy ribbon (on the Chechelnyk vessel from Stina IV): .

These signs are complicated on the painted utensils of the Cucuteni degree and settlements close to it in time. Thus, the middle of a wide ribbon on a vessel with Valea Lupului II is filled with an oblique grid, and at the top in the area that divides the field of painting into metopes, the sign of a snake-water

surrounded by vertical lines is depicted: . On another vessel in the upper tier of the painting, the sign



under study is depicted next to a drawing of an animal:  vertical dashes:  ladders 





triangles . In two cases, on the vertical lenticular ovals that flank the tape, the outside is drawn lines:

. On two amphorae painted with "owl faces", ribbons flanked by ovals are combined with



watermarks: .

The semantic field of the studied sign in the sign systems of Valea Lupului II and Varvarivka XV settlements can be reconstructed as follows: **snake-water** (3 graphemes from Varvarivka XV, 1 - from Valea Lupului II) - **ladder** (3 graphemes from Varvarivka XV) - **animal** (1 grapheme from Valea Lupului II).

On the dishes of settlements of the Bădragii type the middle of these signs are filled with water graphemes: ; snakes - water (Bădragii Vechi:  Konovka, site 1,2 , triangles (Bădragii Vechi).

In some cases, these signs are flanked by double (Bădragii Vechi),  single:  (Bădragii Vechi), double and single signs of a snake – water (Bădragii Vechi:  Hancăuți I: .

In one case, a sign filled with oblique crosses and flanked by two red signs of a snake-water, was located under anthropomorphic elements-markers of the "chest":  (Bădragii Vechi).

Vertical stripes flanked by black vertical hemispheres were depicted under red, empty or cross-filled medallions on “Tangentenkreisband” diagrams (Hancăuți I, Konovka, site 1,2: ). In one case, this sign is located above the medallion:  (Konovka).



In the sign systems of settlements of the Bădragii type the semantic field of the sign has the following form: **snake-water** (5 graphemes from Bădragii Vechi, 1 - from Hancăuți I, 1 - from Konovka pl. 1,2) - **ladder** (1 grapheme from Konovka pl. 1, 2) - **“belly”** of an anthropomorphic vessel (1 grapheme from Bădragii Vechi). So, according to the analysis, this sign was part of a set of ideas of the snake - water.

On ware from the settlement of Zhvanets, we also combine a medallion with lines and with the vertical tape flanked by hemispheres: . Besides, there are no other combinations of vertical tape with hemispheres on ware from this settlement is not present. Such graphemes were not used in the sign systems of other monuments of CII-γII.



Syntax and semantics of iconic characters

As research shows, semantic markers are a kind of “accumulators” of a certain number of characters. This can be found by defining the semantic fields of each of them, which was done in the section on their syntax. These fields often contain iconic characters, which themselves belong to the basic characters. These are crescents of the moon, full moons, water, water-snake. Also, here we often find signs that are not included in the semantic markers, but in one way or another are depicted in the sign systems of different local groups. These signs include zoomorphic, plant, ornithomorphic, anthropomorphic signs-
icons. Perhaps one of the tasks of these signs-icons was a kind of determination of semantic markers, which often did not formally resemble anything in the environment.

Zoomorphic signs

As you can see from our material, the first painted images of animals appeared on the vessels of the end of the BII on the vessels of the Konovka settlement in Middle Dniester, they were applied to two vessels. One of them depicts animals on the second tier of a biconical amphora, between bucrania (?) with black circles on their ends: . The second zoomorphic figure is drawn on a fragment of a bowl: . These two signs make up 1.2 % of the total number of known signs from the settlement of Konovka. The sex of animals is also emphasized on them. The amphora possibly depicts females, and the bowl depicts a male. All images “move” from left to right.

At the beginning of CI-γI, there are more animal signs on the painted dishes of the Petreny and Chechelnyk groups. In the settlement of Petreny, they make up 5.6 % of all signs on the dishes. On six of the 12 signs-
icons, you can determine the sex: 4 females and 2 males. Two females are depicted on the cups, along with drawings of “bumps”; one drawing of the female is drawn in the medallion of the “Tangentenkreisband” scheme: . In the second tier of the painting of this vessel two animals are drawn (male-left and female with tail-ear-ball - right) opposite each other, they flank vertical lines (a sign







of falling water): . These images may indicate the presence of binary oppositions left-right, male-female, in the perceptions of the population of that time. New material is needed to better justify this. Somewhat ahead of the analysis, we note that such contrasts are on the dishes with Valea Lupului II, which will be discussed later. Another flanking of animals, this time a vertical ribbon that divides the painting into two metopes, we have on the cup: .



In Petreny, the tails of some animals started to get represented in the form of plants (ears-ears), which may be evidence of the close ties between animals and plants in the worldview of the population at that time, as noted by Bogaevsky. The biconical vessels in the second tiers of the paintings depict dogs “moving” one after another. The same procession of animals is depicted on the amphora, which is painted “owl face”. Thus, when drawing animals on Petreny dishes, female dogs were preferred (there are no images of bovids). It seems that only females have spikelets. The animals were mostly painted in the second, upper tier of amphora paintings. In the first tiers in these cases, red medallions were painted on the “Tangentenkreisband” schemes. In the vast majority of animals, they “move” from left to right. Hypothetically, animal icons owe their appearance to Petreny ornamentation by “scanning” semantic markers in the form of vertical lines, vertical ribbons, and medallions.

Among the signs from another settlement of the Petreny group, Bernashivka, drawings of animals make up 1.2% of the total number of known signs. Here, for the first time, we have drawings of bovids (whose sex cannot be determined). One of them, "moving" from right to left, has lyre-shaped horns. The horns of another bovid have the appearance of a crescent moon: . All other drawings probably depict dogs. Five of them are females, one male, and one image of a procession of animals depicts a male and a female. All the animals, except the already mentioned bovid, are shown in "motion" from left to right. Most of the drawings (5) are applied in the second tier of the painting of the biconical ware painted by the "Tangentenkreisband" schemes. The medallions on them are filled with black hemispheres (3 characters) or filled with red paint (2 characters).

In the latter case, three fortresses in the upper tiers are depicted next to the red medallion- we are the signs of the full moon: . Another drawing of the female is located near the handle of the amphora painted with an "owl face", where, except in this case, only the signs in the form of crescents of the moon were depicted.

It becomes evident, that the drawings of animals from Bernashivka have much in common with Petreny. But their appearance here is associated with somewhat different semantic markers - medallions with black hemispheres inside, vertical ribbons, and full moon signs. We have the largest number of animal signs among the sign system Shipintsi B - 14.2 % of the total number of signs on the dishes, published by Kandyba. They depict mostly female dogs and only once - males. The marks were applied next to medallions filled with lenticular signs with wavy negative bands inside and vertical bands. All drawings of animals in most cases depict married in "movement"; under the medallions, they were drawn at the

bottom (4 signs):  and twice at the top: . Also, in the second tier of the amphora painting they were painted under black lenticular ovals: , (4 characters), under black ovals connected by scallops: , (1 character), under the wavy ribbon:  (1 sign), on the cups next to the sloping lines and "bumps":  (with signs). One medallion that filled with three

lenticular ovals and two groups of vertical lines, flanked by two animals: . From the above, we can conclude that the appearance of images of animals here is associated with the "scan" of semantic markers in the form of lenticular ovals, straight vertical lines, medallions, black circles, as well as the sign of the plant: .

There are also drawings of animals on the dishes of the Cherkasiv Sad II settlement group. They make up 2.3 % of the total number of characters. These are drawings of dogs (1 female and 2 males, as well as 1 animal, whose gender is impossible to determine), depicted in the "movement" from left to right. All animals are depicted in the second tier of the painting. The two drawings are arranged in circles, reminiscent of an image from Petreny, and drawings of males are printed over the medallions filled with hemispheres. Also, the tails of all animals end in black circles, which also finds an analogy among the drawings of animals Petreny group: . Thus, the appearance of images of animals here is associated with semantic markers in the form of medallions filled with ovals and possibly a black circle. In the

settlement of the second phase of the Tomashiv group Sushkivka, in the first tier of the biconical vessel, there is an image of a fantastic animal, the limbs of which also end in black circles. This figure is flanked by two lenticular ovals, which brings it closer in context to the Shipintsi animals: . In the sign system, this is 0.9% of the total number of known signs.

On the cup from the settlement, which was located on the right bank of the Prut, Frumușica III, a “hump” is painted in the metope, above it - a red crescent moon and a dog (Dumitrescu V., 1979., fig. 154). There are more images of animals on the dishes of the eponymous settlement of the Chechelnyk group than was observed in Cherkasiv Sad II. They make up 8.1 % of the total number of known characters. Among them - 5 drawings of females and 3 - males. In most cases, they were painted in the second tier of the painting (7 characters). In three cases, below them are signs in the form of vertical ribbons flanked by vertical hemispheres (2 signs), and a medallion with hemispheres and vertical lines in the center. These signs belong to the semantic markers, and it is with their “unfolding” that images of animals are connected. Also, the drawings of animals are located in the middle of the zones formed by lying S-shaped figures on a pear-shaped vessel.

On the dishes from the settlement of the Petreny group of Lipchany, we have three drawings of females depicted in “movement” from left to right. These signs make up 3.6 % of the total. On one cup-shaped vessel with a bucranium relief - four animals are drawn, two in each metope, surrounded by the crescents

of the moon: . Also, there is another fragment with a similar pattern. The “imported” cup from the area of the Chechelnyk group shows two females from the tail between the metopes, ending in

black circles: . Thus, in the paintings of this settlement, the animals are associated with semantic markers in the form of the moon. There are also zoomorphic images on the painted dishes from the settlements of the Right Bank of the Prut, which are approximately synchronous with the people of Lipchany. All animal figures are shown in “motion” from left to right. From the settlement of Veleni Piatra Neamț comes a fragment of a cup, which depicts a dog outlined with black dots (Dumitrescu V., 1979., fig. 50a). Dogs, this time female, are depicted in metopes on two cups from the Gelaesti settlement. On one cup the animals are drawn to the left of the “hills”, their raised tails ending in black circles (Dumitrescu V., 1979., fig. 158,7-8). The second cup of animals shows next to the quadrilaterals filled with a grid, the tail of one dog ends in a black circle, the lowered tail of another intersects.

Processions of animals were depicted on the second tiers of the painting on some painted vessels from the settlement of Varvarivka VIII. On four “friezes” the animals “move” one after the other from left to right, and on one - from right to left. One “frieze” depicts two males - opposite each other, and the left - with a tail-ear. The following figures depict a male with a tail-ear, a dog, and a deer (male) (Markevich, V. I., 1985., p. 88., Fig. 87). On another vessel, two male deer are depicted next to a bird (?), a small deer (?), an animal that is difficult to identify, and two dogs (Markevich V. I., 1981., p. 27., Fig. 27). Another biconical vessel depicts four paired double drawings of dogs (two males and two females). Another pair of dogs is depicted on another such vessel (Markevich V. I., 1981. p. 28., Fig. 28). On the anthropomorphic vessel, along with stickers - “chest” and astral signs depicted red dogs (Markevich V. I., 1985., p. 89., Fig. 91; Markevich V. I., 1981., p. 29. Fig. 29, 1). The procession, which consists of five animals, goes from right to left and has a sign in the form of a “comb” (Markevich V. I., 1981, p. 29., Fig.

29, 2). Under four of these “friezes” are painted vertical ribbons flanked by vertical hemispheres, and under two - medallions with hemispheres inside and lenticular ovals next to them.

On the vessel from the settlement close to Varvarivka VIII, Krutoborodyntsi II, the second tier depicts a procession of animals, which “move” from left to right. In the first tier below them, vertical ribbons are flanked by two black hemispheres. The “frieze” itself consists of four animals with spikelets (two goats, a dog, and a deer) and a sign in the form of a crescent moon (Passek T. S., 1941., p. 48. Fig. 24). Thus, the animals on the vessels of Varvarivka VIII and Krutoborodyntsi II are associated with semantic markers in the form of vertical ribbons flanked by vertical hemispheres, medallions with hemispheres, vertical lenticular ovals, and crescents of the moon. On the painted utensils from the settlement of Valea Lupului II, we have 8 signs-icons of animals, which amounts to 11.2 % of the total number of signs on the published utensils.

The paintings of the two vessels, which are divided by vertical ribbons into metopes, show three red animals in the upper tiers, which “move” from left to right (female dogs); they are surrounded by water-snake signs and groups of triple vertical lines, lenticular red ovals grouped in two, double red snake-water

signs together with groups of triple vertical lines (the last signs surround the male figure): 



“Tangentenkreisband” with red medallions and red snake-water signs in tangents, and the second-X-shaped red figures flanked by vertical red hemispheres. The procession of red dogs (females) is depicted on a fragment of a vessel that is similar to the previous ones: 

Two more such vessels, in the upper tiers, depict a male (left) and a female (right), flanking a black crescent-shaped sign with the horns down, surrounded by red dots (star signs?): 

We will remind that similar flanking (vertical lines) with an arrangement of the male on the left, and females on the right is on a fragment of a vessel from Petreny. On another such vessel in the second tier of the painting of the animal (male on the left, opposite the female depicted on the right). In the lower tier of

one of these vessels is a diagram flanking a small animal (puppy?) 

Perhaps these drawings can be interpreted as images of pairs of dogs that give life to the moon, as well as puppies. That is, here is once again the connection between the moon and the dog. In addition to this image, the red dogs were associated with the sign of the plant, and the black, the only animal of this color on a vessel from Valea Lupului II, with a vertical ribbon filled with lines and flanked by two vertical black

hemispheres: 

Thus, the appearance of zoomorphic images in the sign system of this settlement is associated with the “deployment” of semantic markers of the snake-water, lenticular ovals, the moon, a vertical ribbon flanked by vertical hemispheres. On the dishes from the settlement of phase III of the Tomashivka group of Talianki, we have a drawing of a fantastic creature, which is stylistically very similar to the already

mentioned sign from Sushkivka: . Besides, there are two more zoomorphic images in the second tier of paintings. In one case, drawings of a cow moving from left to right are shown above the handles with

horizontal lines and between them: . On another vessel, the picture, which included the sign of the animal, unfortunately, is not fully preserved. The part we have consisted of horizontal lines with lines on

the handle and the animal (male dog) above it, "moving" from right to left: . The paradigmatic series, which includes animal signs, consists of signs of planets, moon, "comb", triangles with a ladder, a vertical line, an oblique tape filled with a grid.

The number of all zoomorphic images here is 0.5 % of the total number of known characters. We have slightly more zoomorphic images in the sign system of the settlement of Maidanetske - 1.9 % of the total number of known signs. Formally, they can be divided into several groups: "realistic" - more or less similar

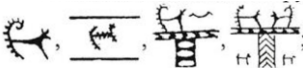

to the image of dogs or bovinds: . "Conditional" - signs for the installation of

which black circles were used, but their general outline still resembles animals:  and abstract

- signs that can be attributed to zoomorphic only in the context of their use: .

Among the latter, there is a sign similar to the already mentioned images of fantastic creatures from

Sushkivka and Talianki: . On a vessel, without handles from Maidanetske, it is depicted in the first tier of the painting. The paradigm of signs that are part of quadrilaterals in similar contexts, in addition to a fantastic zoomorphic figure, also consists of vertical lines; oblique and straight crosses; vertical lines and oblique cross, which form one block; images of plants and plants flanking the vertical mud tape filled with mesh. On the same type of utensils, "conditional" (2 characters) and "abstract" (1 character) images of animals were applied in the second, upper tier of the painting. In the lower tier of the painting, there is

one conditional image: , which is accompanied by drawings of oblique crosses in quadrilaterals and double large black circles. The second "conditional" zoomorphic image has a spikelet tail: . The paradigmatic series of signs of this type of utensils, in addition to those described, include plants; plants next to triangles; moon; "comb"; oblique crosses; triangles next to the vertical ribbon.

Three zoomorphic signs are drawn on the upper tiers of the crater paintings. These are two "realistic images" that are part of the blocks. One of them consists of a picture of an animal next to the moon sign

to the right of the animal, and a vertical wide ribbon filled with a horizontal empty lenticular oval:  under them. The second block consists of drawings of two animals in the upper tier, standing opposite each other. In the lower tier below them is a wide ribbon filled with triangles, which is flanked by two small

drawings of animals (females), "going" from left to right: . The third block consists of "abstract" the image in the upper tier, under which is drawn a wide vertical strip filled with lenticular horizontal ovals,

which is crossed by a vertical strip filled with a grid: .

Most zoomorphic figures "move" from left to right, only one figure is depicted in "motion" from right to left. The number of animal drawings on each vessel is difficult to determine due to their fragmentary nature. Where this can be traced, there are four of them, and they are arranged crosswise on the second tiers of the utensils of the murals. On one cup-shaped vessel in the upper tier of the painting, there are three zoomorphic figures, under which lenticular ovals are drawn. All figures, except for one drawn next

to the plant: , have no signs of males, so we can assume that they depict females. With plants, in addition to the sign just mentioned, there are three other zoomorphic figures with spikelet tails.

Summarizing the observations, we can assume that the images of zoomorphic signs on the vessels of phase III of the Tomasz group are associated with the “scan” of semantic markers in the form of a full moon, its crescent, vertical ribbon, lenticular oval, quadrilateral.

There are also zoomorphic images on the pottery from the settlement of the last phase of the existence of the Chechelnyk group Stina IV. They make up 2.7 % of the total number of known characters. One sign in the form of a female dog in “movement” from left to right is depicted in the second tier of the painting of the biconical vessel:



, the zoomorphic sign is located on the upper part of the amphora, which is painted with the “owl face” scheme. It consists of two animals depicted opposite each other: .

Another zoomorphic sign is also located at the top of the “owl face” scheme, in the area where in other cases double crescents of the moon were drawn:



 Zoomorphic images (females) are drawn in the metopes of the cups. In the same areas other than animals depicted water signs and double moon signs. It is difficult to determine which semantic markers these images are associated with because of the strong fragmentation of the vessel on which they were applied. It is noticeable that the drawings of animals are connected with the “owl face” schemes, which seems to be considered a stable tradition of the Petreny group. There are no such images in the paintings of other groups (except for the Cucueti phase). Among the painted utensils from the settlement of Northern Moldova Shura I, is a cut-spherical bowl, inside which a group of animals is depicted. It consists of two figures of bulls with lyre-shaped horns, a dog (female) and another animal, the image of which is not fully preserved (Bikbaev, V. M., 1989., Fig. 2, 3). On another vessel, which the author of the excavations considers archaic (ibid. p. 56), in the upper tier of the painting is a picture of a dog (female). In its lower tier, which is painted by the scheme “Tangentenkreisband”, the medallions are filled with semicircles, the tangents depict the signs of the snake - water (Bikbaev, V. M., 1989, p. 56., Fig. 19). Among the sign system of the settlement Varvarivka XV on a fragment of a vessel there is a drawing of red a dog that “moves” from left to right:



. Bulls with lyre-shaped horns, depicted in the same direction, are placed in the upper part of the amphora, which is painted with the scheme “owl face” (Markevich V. I., 1985, p. 90., Fig. 92). Zoomorphic images make up 0.9 % of the total number of signs on the dishes of Varvarivka XV.

The drawings of animals in the settlements of the Kukuyet degree are close in their contexts to the previous and partially synchronous Petreny traditions. They are associated with semantic markers in the form of a medallion with semi-ovals (Shura I) and the “owl face” scheme (Barbarian XV). On the pottery from Bilche Zolote Verteba I (Upper Dniester), the images of animals (female dogs) “move” from left to right are most often (3 times) located on the “Tangentenkreisband” diagrams next to medallions between tangents



; where they were sometimes replaced by drawings of snakes. Also, the image of four rings is on one of two arcs that go one after the other, depicted inside the bowl. In its center is a cross with black circles at the ends and inside and double red crescents of the moon on its sides: .

On one fragment of the vessel, we have a picture of a red bovid with lyre-shaped horns:  On a vessel with a cylindrical high neck, a drawing of a bovid with lyre-shaped horns is located in a large lenticular

oval in the lower tier of the painting; in the oval, which is depicted above it, is drawn the equivalent of the sign of the serpent - water (Chernysh, E. K., 1982., p. 308., Table. LXXXVII, 6).

Thus, the appearance of images of the animal on the dishes of Bilche Zolote Verteba I can be associated with semantic markers in the form of snake-water signs and the moon. In the settlements of the right bank of the Prut, there are also signs of animals. Thus, a vessel from the settlement of Trușești is painted with four dogs, above and next to which the red crescents of the moon and circles crossed by inclined ribbons are depicted (Dumitrescu V., 1979., Fig. 155). As we remember, these two signs belong to semantic markers. In the cup from the settlement of Cucuteni B 2-1 (Op. cit., p. 60. Fig. 50) the red dog has a tail-spikelet. The same dogs are depicted inside a truncated-conical bowl, which is painted with a diagram in the form of the number "8". They are located next to the red signs of the snake-water and astral figures (Or. Cit., p. 63., Fig. 52).

Among the sign system of the settlement of Bădragii Vechi, zoomorphic images are located next to the medallions in the painting scheme "Tangentenkreisband". One of the images shows a red bull with lyre-

shaped horns next to an indefinite medallion, which "moves" from right to left: . On another vessel, a red dog (female) was applied at the bottom of a tangent filled with steam red signs of the snake-water

that connected the medallions with black hemispheres and crosses: . A similar scheme depicted a dog (female) in a large lenticular oval, and in another case, a lenticular oval depicted a bull "moving" from right to left, combined with a series of red rhombi, as we have shown earlier, the equivalent of a snake-

water: . Image animals in the sign system of this settlement are 1.8 % of the total number of known signs. A slightly higher percentage - 2.4 % of the total number of analyzed signs - have zoomorphic images on paintings from the settlement of the Bădragii type - Hancăuți I. In one case, there are drawings

of dogs surrounded by double signs of a snake - water: , in the second case - the image of a female, below which were two W-shaped signs are drawn one above the other - the equivalents of a water snake:



Five red cows with lyre-shaped horns are depicted in the upper tier on a vessel with a high cylindrical neck and an extended body divided by two wide ribbons into two metopes. Two of them are depicted in large lenticular ovals and three - outside them. Below, in the middle tier of the painting, in ovals are drawn semantic markers - vertical red ribbons next to other markers - four red signs of the snake - water. Also, there is a picture of a red animal (possibly a cow). In the lower tier, in a large lenticular oval, a black animal is depicted. The whole composition, in our opinion, can be considered as an image of the opposition black (bottom) - red (top), as well as red signs of the snake-water and vertical ribbons (bottom - middle) - red cows (top). Thus, the signs in the form of animals on the dishes of monuments of the Bădragii type are associated with the "deployment" of semantic markers in the form of a snake-water, vertical ribbons, medallions filled with semi-waves. Among the utensils from settlements such as Brynzeny III - Zhvanets there are also zoomorphic signs. In the sign systems Brynzeny III and Costești IV, they were part of multi-figure compositions. One of them comes from the settlement of Brynzeny III (Markevich V. I., 1981., p. 43. Fig. 59.1). It consists of two tiers. In the lower tier, in five lenticular ovals connected by tangents, anthropomorphic figures are depicted (two of these ovals are empty). In the upper tier, in addition to the anthropomorphic figures depicted in the two ovals, are painted bovid (gender is indeterminate) and

horizontal rows of red rhombi which are equivalent to the sign of the snake-water. The fields between the tangents and ovals here are filled with red paint. Thus, on this vessel, we also observe images of binary oppositions: bottom (anthropomorphic figures) - top (anthropomorphic figures, signs of the water snake and animals, as well as red). On a fragment of a vessel from Costești IV (?), a similar structure of the figures inside a large lenticular oval is found: below an anthropomorphic figure, inside a cow with calves, and above a sign of a snake-water (Markevich V. I., 1981., p. 48., Fig. 72, 4).

In another fragment of the "frieze" from Costești IV (Markevich V. I., 1981., p. 48., Fig. 72.1) double figures of animals "moving" from left to right, flanked by vertical red rhombi - the equivalent of the sign of the snake - water. Between them, under the tangents in smaller ovals, anthropomorphic figures are drawn, one of which holds something in the hands raised above the head and which is also flanked by animals; in one oval the anthropomorphic figure is depicted without animals. Unfortunately, only the upper tier has survived from this "frieze", and we cannot observe the image in the lower tier.

The dishes from Zhvanets depict two zoomorphic figures, which is 0.6 % of the total known number of signs. In one large lenticular oval, a zoomorphic image is drawn over an oblique cross. As we remember, zoomorphic figures were associated with the sign of the cross in the sign systems of Bilche Zolote Verteba I and Maidanetske.

Ornithomorphic signs

Icon-signs in the form of birds were used in the sign systems of Trypillia-Cucuteni quite rarely. The first known drawing of a bird is found on a fragment of a vessel from Brynzeny VIII (stage BI) (Markevic V. I., 1985., p. 81., Fig. 76). On a large biconical vessel from the early settlement of the Petreny group - Brynzeny IV, stage I, a “flying” bird is depicted from left to right in each of the two metopes under the tangents (Markevich V. I., 1981., p. 17., Fig. 7, 4). On a fragment of a vessel from the settlement of Glavan I there is also an image of a bird (Bykbaev V. M., 1992., p. 105., Fig. 17).

In the settlement of the Right Bank of the Prut, close in time to Velena and Lipchany, - Buzni - four birds in negative ovals are depicted on a bowl, which is divided into four zones by an oblique cross (Dumitrescu V., 1979., R. 65., Fig. 54). Birds here also “fly” from left to right, and their appearance can be associated with a cruciform pattern (i.e. a semantic marker in the form of a cross).

Around this time, bird-icon signs also appeared on the painted utensils of the Middle Dniester settlement of Lipchany. They are depicted on the second tier of the biconical vessel painting: . Stylistically, they are similar to birds from Buzna. Their appearance can be associated with the “unfolding” of the semantic marker in the form of a vertical ribbon flanked by vertical black hemispheres. There are none in the settlements of the Chechelnyk and Tomashivka groups. There are none at the very end of the CI-γI stage on the dishes of the Bădragii-type settlements. Nonetheless, one ornithomorphic was found image on a fragment of a vessel from Koshylivtsi Oboz.



In the territory between Prut and Dniester rivers as well as Middle Dniester, ornithomorphic signs reappear on painted vessels of settlements of the Brynzeny III-Zhvanets type of stage II. Thus, on the fragment of the amphora, from which the upper tier of the painting has been preserved, between four large lenticular ovals are depicted four birds that “move” from left to right (Markevich, V. I., 1985., p., 97. and p. 101). Signs-icons of birds in the sign system of the settlement Zhvanets are depicted only on dishes with high cylindrical necks and stickers at their bases. On the body of one of them, in lenticular ovals, birds are depicted on high legs, flanking a vertical ribbon with stripes; in another lenticular oval with a gluing in the





upper part, which is located next to it, a slanted cross is drawn: .

The paradigmatic series of signs of this zone includes drawings of a snake-water, their equivalent - a horizontal row of red rhombi, oblique and straight cross, and paired or single astral signs. On the second such vessel in the upper tier, there is another drawing of a bird on high legs. Its paradigmatic series is similar to the previous one, but it lacks astral signs in the form of circles with lines-rays.



Thus, the signs-icons of birds are connected here with semantic markers in the form of a **vertical ribbon and an oblique cross**, signs-icons of the **snake-water** and their equivalents.





Signs of plants

There are no images of plants on the dishes from the monuments of stage BII, even though the total number of dishes from some settlements is quite significant. It seems that the first images of plants appear on the upper tiers of paintings of amphorae from Shipintsi B: . Here we have two signs of plants, which is 1 % of the total number of known characters. On one amphora, as already mentioned, plants are depicted next to drawings of animals: . In the early settlements of the Petreny group, there are no signs of plants on the dishes.

Only the tails of dogs (females) in the pictures from Petreny end with plants:  what tool can be concluded that in their first manifestations the signs of plants were closely intertwined with zoomorphic ones. In the sign systems of the Tomashivka group of the second phase of development (the settlements of Chicherkozivka and Dobrovody) the signs of plants were drawn inside the bowls:  (3 signs from Chicherkozivka make up 4.6 % of the total number of known characters) and in the "triglyph" of the cup, on the "hump":  (1 sign from Dobrovody - 1.3%). In this area, it is once replaced by a sign in the form of a ladder: . This replacement may indicate the presence of the idea of a plant (tree?) as the equivalent of a ladder connecting the lower "earthly hump" with the upper "celestial hump", which is shown inverted relative to the lower.

The sign system of the settlement of the III phase of the Tomashivka group of Taliunki shows an increase in the number of signs of plants. Here we have 33 such drawings, which is 6.1 % of the total number of characters. In most cases (17 characters) they were depicted in the second (upper) tier of the painting. The paradigm of the signs drawn here, apart from plants, consists of animals; "Combs"; triangles; triangles and ladders; flowing water (vertical wavy ribbons) and falling (vertical lines); inclined tapes filled with mesh; months.

13 signs of plants have the form of a drawing of one plant, 1 sign consists of two plants depicted side by side: , another sign has the form of three plants drawn side by side: . There is also a more complex sign of a plant, consisting of drawings of single plants next to the inclined ladder that connects

this tier of the painting with the second, which also depicts single plants: . 12 signs of plants (36.3% of their total number) are drawn in the metopes of the cups, on the "hills". They are included here in a paradigmatic series consisting of lenticular ovals; vertical rows of dashes; oblique cross; straight and oblique tapes, which are filled with a grid; a small quadrilateral, also filled with a grid. Inside the bowls, the plants are depicted twice. On one they formed they draw a cross-shaped composition:  and on the second they are depicted next to the arches that enter one by one, ending in the crescents of the moon next to a series of dashes (signs of falling water), 18 plant signs are components of the blocks. The largest number of them (7 -21.8 % of awards plants) is associated with signs in the form of horizontal lines on the handles in the first tier: , another sign looks like three plants drawn side by side: . There is also a more complex sign of a plant, consisting of drawings of single plants next to a sloping

ladder, which connects this tier of the painting with the second, which also depicts single plants:  Four signs of plants (12.1 %) depicted above lenticular ovals, which are filled with oblique mesh - (2 signs),

one with a vertical line inside (1 character): . The two plant signs are



connected by vertical lines in the first tier:  and black circles (signs of the full moon). In one case, a

black circle is drawn above the signs of the plant: , and in the other - a horizontal pattern of the plant in the upper tier of the painting is flanked by black circles. In the first tier, black circles flank a wide vertical

strip filled with horizontal ones lenticular ovals: .

As you can see, the signs of plants on the dishes from Taliianki are associated with the “scan” of semantic markers in the form of lenticular ovals (grain signs), black circles (full moon signs), vertical and horizontal lines, crescent moon, vertical lines (a sign of falling water), cross. The sign in the form of a plant is on a bowl from the settlement of Varvarivka VIII. It seems that this is the first such image on the dishes of the Petreny group (Markovich V. I., 1981., p. 26., Fig. 25, 7). The scheme in the form of the number “8”, in our opinion, should be considered the influence of other sign systems, most likely - Tomaszow. In this regard, recall the sign in the form of a “comb” on the frieze, which depicts the procession of animals. This sign is also not typical of Petreny paintings, but it is on the dishes of the Tomashivka group.

In the settlement of the right bank of the Prut - Valea Lupului II on the cup next to the zoomorphic image, there is a picture of a plant. There are a few more signs of plants on the paintings of utensils from the Kukuyet degree settlement. Thus, among the sign system of the settlement of Varvarivka XV, images of plants make up 2.9 % of the total number of signs. They were located in the upper tiers of the painting of amphorae, painted with schemes “Tangentenkreisband” and were part of the signs of the paradigmatic series, which consists of signs of a snake - water, moon, bucranium (?).



According to their style can be divided into three groups: trees with branches: , fir trees: , plants from the trunk- we are in the form of a vertical ribbon: . The last character has not been used before. In addition to Varvarivka XV, these signs are also depicted on a cup from Kosenivka (Passek T., 1935.,

Tabl. XV, 6) and the paintings of dishes from Maidanetske: . On the dishes of the settlement of Shura I the image of a large tree surrounded by various, smaller in size, signs in the form of snakes, oblique crosses, and U-shaped images is painted on an amphora (Bikbaev V. M., 1989., p. 56., Fig. 3, 3). Another image of a tree is on the bowl. This picture is interesting because the plant “grows” from top to bottom (ibid. p. 55., Fig. 2.2). This may indicate some idea of a tree growing up by its roots. Similar images, but inverted “humps”, sometimes with “grass” on them, we see in the cups of the Tomashivka group.

Inside the “triglyphs” of cups from the settlement of Stina IV, we have two drawings of plants, which is 1.3% of the total number of signs known here. These images are an example of rather complex processes in sign systems at a late stage of existence of the Petreny and Chechelnyk groups. The scheme of painting the cups finds analogies in the ceramic complexes of the Chechelnyk group, although plants





have never been depicted there in the metopes. Thus, the plants in the metopes of Stina IV cups appeared due to other influences, most likely Tomashivka: .



The paradigmatic series of signs in the metopes of cups consists of vertical ribbons that connect two "humps", dashes and vertical lines between them. Most often, icon-signs of plants were used in the sign system of Maidanetske (Phase III of the Tomashivka group). There are 129 such signs, which is 12.8 % of the total number of known signs from this settlement. Most of the signs (73) are drawn in the second (upper) tier of the biconical ware. A certain number of them (29 characters - 22.4 % of the total number of drawings of plants) are depicted in the "triglyphs" of the cups, on the "hills". Here they are part of a paradigmatic series, which, in addition to plants, consists of lenticular ovals, ladders, descending lines, vertical strips filled with a grid (Maidanetske).







On three cups in one of the metopes a lenticular oval "on a hill" was depicted, and in the other - also on a "hill" - a sign of a plant. On another cup, the plant and the lenticular oval are drawn in one "triglyph" and on one "hump", which once again very clearly emphasizes the connection of these two signs:  25 signs (19.3 %) of plants are components of blocks with lenticular ovals, which in the lower tiers are applied on the handles of biconical utensils:  In one case, the oval was flanked by ladder signs, and into the



second - black circles (signs of the full moon):  (Maidanetske).

Paradigmatic series of signs of biconical vessels and craters include plants, consist of images of animals; "Combs"; triangles; ladder; a small quadrilateral filled with a grid; oblique crosses; vertical lines; "Stars". The 37 signs of plants depicted in the second tier consisted of a single drawing of plants, two of which, as already mentioned, find analogies in the pottery from Kosenivka and Varvarivka XV. Also, we have one



drawing of a tree with five branches:  18 signs consist of double images of plants  and 6 - of a triple: . One sign in the form of double plants, the branches of which end in white dots, is drawn inside a border filled with horizontal lines. The four signs look like triple branches: . A sign in the form of triangles filled with a grid is closely connected with plants. It is located near four single signs of plants:





 and one sign of a plant with triple branches: .



Also, next to the plants in the second tier of paintings biconical utensils are inclined ribbons filled with a grid: ; an animal that "moves" from left to right: . The tails of two more animals end with drawings of plants, which, given the similar images on the dishes from Petreny, indicates a general round of ideas associated with the union of plants and animals into one. In addition to vertical signs of plants, horizontal signs were drawn in these areas. One such plant seems to grow from a black circle: . The second figure shows horizontal semi-curved "branches" (?): . Another sign consists of images of vertical and horizontal plants drawn side by side. The same sign is depicted in the lower tier of the painting: . In general, images of plants in the lower tiers of the painting of utensils are quite rare (known 6 signs - 4.6 % of the total number of plants). They were drawn in quadrilaterals in the form of a single vertical image:  or flanked. On the craters of the game, the signs of plants were located on the

mono vertical mesh-filled tape: . On the craters, three plant signs were located on the moon-like sign: . A similar image, but of one plant, is on a fragment of the cup: .

The second sign, which was part of the block with plants in the upper tier of the painting, has the form of horizontal lines on the handle, often with various applications in the form of inclined ribbons and ribbons filled with mesh. The number of these blocks is 13.1% of all plant signs: .





Signs of plants were also painted on bowls. One such image was applied in the middle of wide strips, one after the other. The paradigmatic series of signs depicted here consists of dashes, rows of parallel lines, oblique crosses, oblique crosses and dashes, ladders, perpendicular lines, and a ribbon filled with a grid. Signs of plants form cross-shaped compositions on bowls as with the sign of the full moon inside:  and without it: . In two cases, they “grow” from the center to the edge of the bowl, and in the other two - vice versa, from the edge to the center. On one bowl, next to the plants, a cruciform composition is formed by streaks (signs of falling moisture).

There are 11 plant signs on the pottery from the settlement of Talne II at that time, which is 16 % of the total number of known signs. Six of them are depicted in the second tier of the painting of biconical utensils, where, also, there is a sign in the form of a triangle. Three of these signs consist of a pattern of one plant, one of. One sign of which is included in the block. Below it, the horizontal lines are drawn on the handle:  are given from a double drawing of plants:  and two more - from triple images of plants, one of which is located above the double ovals around the handle . Five signs of plants are depicted in metope cups, and in other cases, lenticular ovals: .

There are 25 plant signs on the painted pottery from the memorial settlement of the IV phase of development of the Tomashivka group, which is 13.5 % of the total number of known signs. Most of them (16) is located in the metopes of the cups, on the “hills”: . In the center of the bowl, where in other cases the signs of guides were drawn, several plants are located: . On one block, which consists of horizontal lines on the handle and double signs of plants, they (plants) seem to grow from two black circles (signs of the full moon): .

The above observations on the use of plant icon signs in the sign systems of Maidanetske, Talne II, and Tomashivka allow us to see that the appearance of these signs here is associated with the “deployment” of semantic markers in the form of lenticular graphemes (grain signs), groups of horizontal lines, oblique or straight crosses, the full moon, and it's crescent. Signs of plants were rarely used on dishes from settlements of the Bădragii type. Thus, the two signs that we have in the sign system of Hancăuți I, make up only 0.9 % of the total number of known signs. They are depicted under the tangents of amphorae painted with the “Tangentenkreisband” scheme: . Another amphora in this area depicted an animal with two W-shaped signs below it. Also, the sign of the plant was drawn inside a large lenticular oval,

wherein other cases painted vertical ribbons, a vertical red sign of the snake-water, hook-shaped signs next to W-shaped signs: .

In the settlement of Konovka (1, 2) in a large lenticular oval on a vessel, the plant is drawn: , which includes 1.4 % of the total number of known characters. Another vessel in this area depicts vertical black semi-flanks flanking a vertical ribbon. Thus, the appearance of plant signs in the sign systems of the Bădragii Vechi can be associated with semantic markers in the form of vertical lines and signs of the snake-water. There are a large number of plant signs on the dishes from the settlement of Upper Dniester Koshylivtsi Oboz – which amounts to 11.4 % of the total number of signs. Most often (3 times) the signs of plants were depicted on the second tier of paintings. One sign is shown to the right of the crescent moon in the first quarter: , as well to the left of the “hump”: . Another sign of the plant is located inside the oblique lines: . Besides, the sign of the plant is drawn between the tangents, next to the large black circles . The fragmentary nature of pottery does not allow us to determine exactly which semantic markers they are associated with. Only one fragment near the plant shows the semantic marker - the crescent of the moon.

Little is known about the dishes and signs-icons in the form of plants from settlements such as Brynzeny III - Zhvanets. Thus, among the sign system of the settlement Zhvanets, there are only two such signs, which is 0.6% of the total number of known signs. But they are part of a fascinating paradigmatic series, which consists of vertical ribbons, snake-water signs, and their equivalents - rows of rhombuses, vertical triangles, a vertical series of W-shaped signs, anthropomorphic images, an oblique cross. At the settlement of Costești IV, there is an amphora with iconic signs of plants depicted in lenticular ovals. Next to them in another oval depicts the sign of the snake-water (Markevich V. I., 1981., p. 47., Fig. 71,3).

The most vivid function of the plant code as a determination of semantic markers manifested itself in the sign systems of the Tomashivka group, which made it possible to understand the sign in the form of a lenticular oval in all its variants as a sign of grain (Videyko M. Y., 1989., p. 47), and not a shell, as Bogaevsky believed, or a female sign (according to the interpretation of Rybakov). On the other hand, it gives us an understanding of the role of signs of plants, animals, and others, as the actualization of certain semantic markers, additional credibility.

Anthropomorphic signs

The anthropomorphic signs consist of three groups: forms of ware, schemes of its list, and small anthropomorphic signs.

Anthropomorphic ware

Since the anthropomorphization of pottery, which has its roots in the Neolithic Balkans, is a very archaic phenomenon; we begin the analysis with it. Namely - from the dishes shaped like a "head" of an anthropomorphic creature. One of the most archaic anthropomorphic schemes of painting is the "facial motif". This scheme consists of two pairs of lenticular ovals, inclined to each other, often drawn on a vessel on the principle of mirrored symmetry, separated by a horizontal (and sometimes diagonal in early schemes) tape filled with horizontal lines or other signs. In the middle of ovals – or the "eyes" - sometimes painted circles or ovals – resembling "pupils" were depicted. The combination of these images forms "faces", of which there are usually two on the tableware. Between the "faces" metopes or ovals were formed (around the handles) with different signs in them. The origins of anthropomorphic schemes of paintings (stage B II) lie in the earlier traditions of settlements BI - BII, which are especially evident among the painted utensils from the settlement of Klishchiv (Zaets I. I., Ryzhov S. N., 1992) and as "imports" they are among the dishes from the settlements of the Dnieper - Verem'ja (Khvoyko V., 1904) and Shcherbanivka (Movsha T. G., 1985., p. 219).

"Facial motifs" in Klishchev are available on different types of dishes and have many graphic options. Thus, on the amphora and the cup, this scheme consists of diagonal ribbons that separate the "eyes". The "eyes" themselves are also located diagonally and separated by vertical bands. The ornamental field around the "eyes"-ovals is painted red (Zaets I. I., Ryzhov S. N., 1992, p. 94., Fig. 46,12; P. 96., Fig. 47, 6). On some vessels, the strip that separates the "eyes" is located horizontally (ibid. p. 96., Fig. 47.4). In addition to amphorae and cups, the "front" painting is depicted on a biconical (ibid. p. 99., Fig. 49, 8, 11), pear-shaped utensils (ibid. p. 98., Figs. 48, 12, 14), and lids to it (ibid. p. 98, Fig. 48, 3, 8). As can be seen from the publications mentioned before, the number of "faces" on some vessels is two and four.

Some of them (on the cup and binocular vessel) are associated with horizontal and vertical red lenticular signs (ibid. p. 96., Fig. 47, 4; P. 99., Fig. 49, 11). On the dishes from the settlements of the beginning of stage BII (Rakovets group) Nemyrivske and Stanislavka, the "front" schemes by their types completely coincide with the Klishchiv ones. They are depicted on a cup, amphora, pear-shaped vessel, binocular vessel, and lids. Also, the "front" scheme was drawn on the outside of the crown of the vessel (crater or amphora). In the design of the schemes preserved: vertical stripes that separate the "eyes"; filling the space between the "eyes" -ovals with red paint (much less often than in the previous stage); images of red lenticular ovals between the "faces". But there are also noticeable differences: the ribbons that separate the "eyes" -ovals, become exclusively horizontal; in ovals and metopes between "faces", and one case above them, images of oblique crosses appear (sometimes with four red dots in free fields); inclined ribbons are flanked by black circles, and a black lenticular oval is flanked by them.

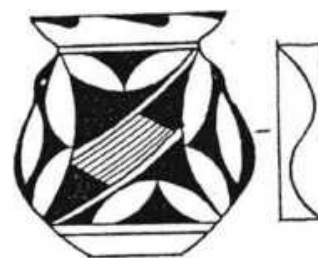

Figure 2

This indicates the further evolution of the scheme "facial motive". But in its presentation, archaisms remain. Thus, on the amphora from the settlement of the beginning of BII Miorcani, the "front" scheme resembles some Klishch paintings - a ribbon that separates the ovals "eyes", located diagonally. In the

ovals near the handles were depicted vertical wavy lines - signs of water (Nitu A., 1961., p. 281) (Fig. 2). On the vessel from the settlement of this time, Florești V "front motif" is depicted on the tire

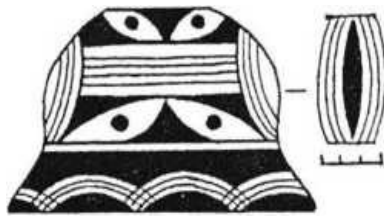

Figure 3

(Todorova T. D., 1992., p. 67., Fig. 4, 17) (Fig. 3), a pear-shaped vessel and a trinocle (ibid.), p. 64., Fig. 3.9) (Fig. 3). An amphora is painted on the eponymous settlement with a "frontal" motif (Popova T. A., 1989., Fig. 2). Thus, at the beginning of stage B II, the "facial motifs" were associated with red and black lens-like ovals/grain marks (?) / A black oval flanked by black circles/grain sign surrounded by full moon signs (?) / oblique crosses / oblique crosses with red circles in

the free fields near it / a water sign / inclined ribbons, flanked by black circles.

Thus, at the stage of BI-BII and the very beginning of stage BII, we can distinguish the first phase of development of the "facial" scheme of painting, associated with the creation of a certain canon. Then, at the BI stage, the "facial motif" of the painting became widespread. We have utensils with this painting in the settlements of Middle Dniester and Prut basin: Kadiivtsi, Kudryntsi, Holoskiv, Studenytsia, Loivtsi, Bakota, Brynzeny VIII (Markevich V. I., 1985., p. 78., Fig. 71), Mereipovka (Sorokin V. Y., 1983., p. 106., Fig. 3,1). Todireni (Zaharia N., Petrescu-Dimbovita si Zaharia Em., 1970., Pi. CCXIII); in the settlements of Eastern Volhynia: Korzhivka ur. Pasychysko, Hromada (Kruts V. O., Ryzhov S. M., 1988., p. 105-108); in the settlements of the Middle Bug basin: Voroshilovka and Pines (Gusev S. O., 1993. p. 120., Fig. 4, 8,7), Nemyriv (Chernysh E. K., 1982., p. 296., Fig. 20). "Facial" motifs are also present in the settlements located in the basin of the Gorsky Tikich River: Gordashivka, Peregonivka, Nebelivka (Kruts V. O., Ryzhov S. M., 1985, p. 51., Fig. 31), Pischana (Ryzhov S. M., 1993., p. 104., Fig. 2.1), as well as among the dishes from Volodymyrivka, located on the river Sinyukha (Passek T. S., 1949., p. 105., Fig. 4; Yakubenko O. O., 1992., pp. 64,9,16) and Garbuzyn on the river Ros (Tsvek E. V., 1989., p. 114., Fig. 6,1,2,4,5-8,11). Pottery from the settlements of the Volodymyrivka or Nebelivka

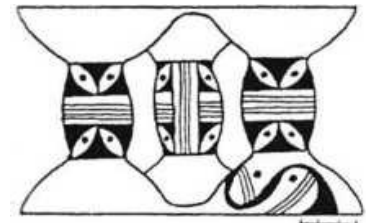

Figure 4



Figure 5

group was found in the steppe (Ryzhov S. M., 1993., p. 112). Among them is a fragment of a cup with a "front" motif of a painting, which was found in the settlement of Novorozanivka in the Mykolayiv region (Shaposhnikova O. G., Neprina V. I., 1977, p. 59., Fig. 5).

The "facial motif" of the paintings from the material of this time is surprisingly monotonous. "Faces" on one vessel are two (the exception is the image of three faces on a pear-shaped vessel from Peregonovka and four - on amphorae from Kadievets (?) (Fig. 5), Hromada and a pear-shaped vessel from Pischana (Fig. 6). Horizontal ribbon, which separates pairs of

"eyes" - ovals, usually filled with horizontal lines (Fig. 5) (except for images on a pear-shaped vessel from Gordashivka, where vertical lines were drawn in the ribbons), the painting is done in black or dark brown paint.

All this, in our opinion, indicates the existence of a certain canon regarding the image of "faces" on the dishes. They painted cups, amphorae, game-shaped utensils, and, occasionally, "binoculars". Also, on the outside on the crowns of the craters (rarely inside, and sometimes on both sides), depicted pairs of "eyes" (Fig. 7). Unlike the early paintings, the "front" motif was not painted on the covers. The canon determined not only the drawings of "faces" but also the signs that were depicted on them.

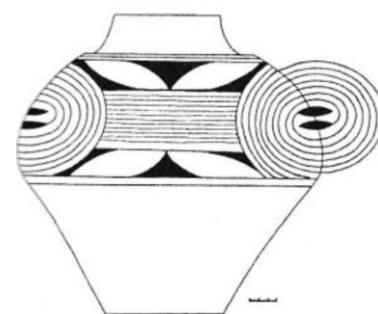

Figure 6

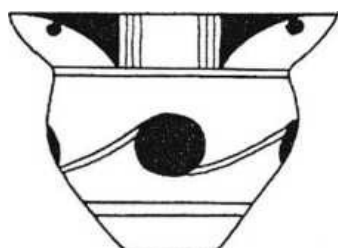

Figure 7

Thus, the signs in the form of two black circles, which were drawn inside the cups on the inner side of the crown, are in such distant settlements as Mereshovka, Korzhivka, and Voroshylivka. As well as black lenticular ovals and their equivalents - vertical stripes on the "humps" or without them between the "eyes", outside the crown of the craters or in their middle (Holoskiv, Voroshylivka, Volodymyrivka, Pischana), as well as between the faces "on" binoculars "(Kudryntsi, Voroshylivka). It is possible that the this also applies to the sign in the form of cross-shaped lenticular black ovals between the "faces" on amphorae from Brynzeny VIII (3 ovals), Pischana (4 ovals) and Sosny (2 ovals) (Fig. 8), as well as the environment of the amphora handles. two circles, inside which groups of lines were drawn (Nszvisko III, Volodymyrivka, Pischana).

Traditional images include drawings of oblique crosses between the "faces" on a pear-shaped vessel from Garbuzin, which finds parallels in earlier paintings of the beginning of the BII (Nemyrivke). This also applies to the flanking of black circles of corrugated tape on a pear-shaped vessel from Peregonovka. Transformed equivalents of this sign are images of oblique ribbons, flanked by black ovals, between "faces" on amphorae from early settlements of the BI stage (Rakovets, Nemyrivske, Stanislavka).

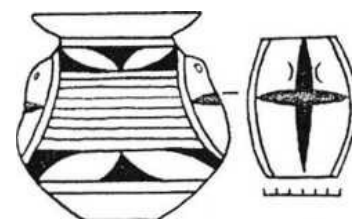

Figure 8

At the dwellings of the settlement of Volodymyrivka, it was possible to trace the distribution of utensils with a "face" painting. Of the 9 dwellings (dwellings 6, 7) excavations in 1940 (dwellings 7, 8, 10, 17, 22) excavations in 1946 (dwellings 2), and excavations in 1947, the material of which (in terms of number and condition of preservation) allows such observations. We have two amphorae with "front" paintings on two dwellings (dwelling 17, 1946; dwelling 2, 1947). On one dwelling there are two amphorae and two cups with such paintings (dwelling 10, 1946). Another dwelling has two cups with "faces" (dwelling 6, 1940). At other dwellings, one amphora with "front" painting schemes was found (dwelling 6, 7, 1940; dwelling 7, 8, 22, 1946). This vessel was associated with the notion of some beings who were endowed with the property of foresight (4 "eyes" with which this creature "looks" in two opposite directions). Images of them were to be found in almost every building. Besides, they sometimes embodied some binary representations. The creatures themselves were associated with the moon, grain, and water. The stylistics of the "face motif" of the painting changes at the CI stage. These changes took place in two ways. First, in the design of the "faces" ovals "eyes" were located more horizontally than in the stage of BI, sometimes only triangles remained from them. In the ribbons that divide the ovals "eyes", the horizontal lines, which are obligatory at the stage of BII, are depicted less and less: they are either empty

or filled (in the Tomashivka group) with other images. Also, the “facial motif” gradually disappears from cups, binoculars, craters and is painted only on amphorae with handles. All this allows us to realize, that the canon formed at the stage of BII is being changed.

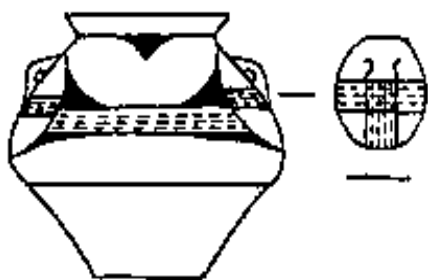

Figure 9

The change of style of “faces” took place differently. Most likely, it took place at the early monuments of the CI stage of the Shipintsi subgroup Shipintsi B (Kandyba O., 1937., R. 53, 55) (Figs. 39-41), Bilche Zolote Park III (Ossowski G., 1892, Tabl. III, 2) (Fig. 9), Khodorovtsi and northern settlements of the Petreny group proper, Brynzeny IV (Markevich VI, 1981., P. 18., Fig. 9, 1, 2), Bernashivka. Here the changes took place, on the one hand, by schematizing the painting, which led to the disappearance of four-

eyed “faces” and the appearance of two-eyed, and on the other - an increase in the number of characters within the scheme.

The amphora from Khodorovtsi depicts straight crosses between the two-eyed “faces” - perhaps a tribute to the traditions of stage BII (Fig. 10). And between the “faces” on the amphorae from Bernashivka in most cases were drawn moon signs, once depicted here are double black circles and water signs. Observation of the distribution of amphorae in the settlement of Bernashivka allows us to identify 8 samples on three dwellings of this settlement (dwellings 1, 6, 7); on dwellings 2 - 11 samples; on dwellings 3 - 5 samples; on dwelling 4-1 sample; on dwelling 5 - 3 amphorae.

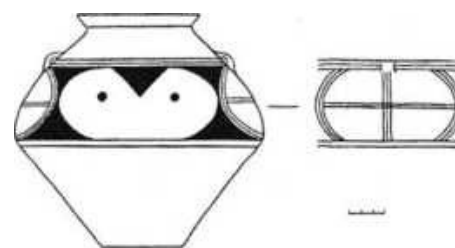

Figure 10

Among the ceramic complex from the more southern settlement of Petreny, the traditions of stage BII are preserved in the design of the “frontal” schemes. For example, they were painted on cups (Stern E. R., 1906., Tabl. VI., 9; Tabl. VII, 6), which is not observed in the monuments of the north. Besides, amphorae are painted with “facial motifs”, the style of which is typical of stage BII (ibid., Tables. VI, 6; Tables. VII; Tables. XI, 7).

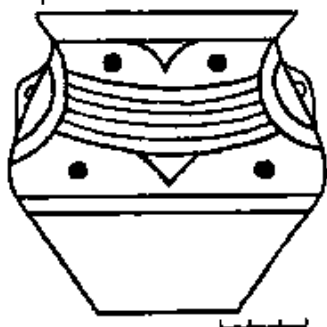

Figure 11

Among the ceramic complex from the more southern settlement of Petreny, the traditions of stage BII are preserved in the design of the “front” schemes. For example, they were painted on cups (Shtern E. R., 1906., Tabl. VI, 9; Tabl. VII, 6), which is not observed in the monuments of the north. Also, amphorae are painted with “facial motifs”, the style of which is typical of the BII stage (ibid., Tables VI, 6; Tables VII; Tables XI, 7). The archaic features inherent in amphorae from the settlements of Nezvysko III, Volodymyrivka, and Pischana include images around the handles of amphorae with circles inside them (ibid., Table XI, 7). Near pens, between the “faces” on the amphorae of Petreny depicted moon signs.

In the settlements of the Chechelnyk group of Cherkasiv Sad II and Kyrlyivka, the schematization process took place in a place similar to the environment of the Petreny group. However, it seems that here, in

contrast to the Shipintsi and northern monuments of the Petreny group, “four-eyed” faces have been preserved longer (Polishchuk L. Y., 1989 p. 42) (Fig. 11). In the later settlement of Chechelnyk, there is a very transformed scheme of “front” two-eyed painting (Fig. 12). On the dishes from the settlements of the early phases of the Tomashivka group Stara Buda, Sushkivka, Chicherkozivka, Dobrovody, one can also see a schematization

of the “faces”, however, this process was slower here. They have stored images of “four-eyed faces”, between which there are moon signs (From the grapheme from Sushkivka, 1 – from Chichsrkozivka); horizontal lines (1 grapheme from Chicherkozivka, 1 - from Dobrovody); horizontal lines and wavy ribbon (1 grapheme from Dobrovody); lenticular oval on the moon (1 grapheme from Dobrovody); vertical lines (1 grapheme from Sushkivka); ribbons filled with a grid (1 grapheme from Sushkivka, 1 - from Chicherkozivka); flanked by two black circles lenticular oval (1 grapheme from Sushkivka); polygram in the form of vertical lines on the moon (1 grapheme from Sushkivka); lenticular ovals (1 grapheme from Chicherkozivka, 1 - from Dobrovody); black circle (1 grapheme from Dobrovody). Sometimes very archaic features can be seen in the design of the “faces”. Thus, black circles- “pupils of the eyes” are replaced on the amphora from Sushkivka by lenticular ovals with a negative wavy ribbon inside. Analogies to this can be found at stage BI-γII (Ticks). On the amphora from Dobrovody between each pair of eyes, there are vertical lines (the most famous analogies are amphorae from settlements of the BI stage).

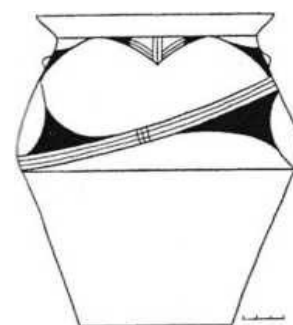

Figure 12



Figure 13

From the settlement of Lipchany, from dwelling 1 (not completely excavated) comes 1 amphora with a “front” painting; and 4 such amphorae were found at dwelling 2. Stylistically, they are similar to Bernashivka, i.e. they depict “faces” with two “eyes”, although the amphora from dwelling 1 retains more archaic features - a horizontal ribbon filled with lines, in the “eyes” are quite large “pupils”. But the “eyes” on this amphora are still two (on one “face”), not four (Fig. 12). There are almost no signs between the “faces” on the amphorae from this settlement. Only one of them, which was found at dwelling 2, shows vertical wavy ribbons-signs of water. The tradition of painting continued on the amphorae from the settlement of Stina IV (Fig. 13) northern monuments of the

Petreny group - they depict “faces” with two “eyes”.

One of the amphorae in-between “faces” has pictures of horizontal positive and negative lunar signs (Fig. 14). On the dishes from the settlement of the third phase of the Tomashivka group of Talianki, the “frontal” motifs are similar to the previous paintings (phase II). There are 55 different characters between the “faces”. Up to 25 of them include horizontal lines on the handles; 14 consist of lunar signs (themselves or in blocks); 10 - of lenticular ovals - signs of grain; 12 - of vertical lines (7 of them are filled with a grid).



Figure 14

Observations of the location of amphorae with "facial" paintings on the excavated dwellings of this settlement allow us to notice that out of 17 dwellings, the material of which allows for such an analysis, 7 have 4 amphorae (dwellings 7-9, 18, 19-21), two more amphorae were found on 2 dwellings (4, 15), we have 1 amphora on five dwellings (5, 6, 10, 16, 17), there are no such amphorae on one dwelling (3), on-dwelling 13 there are 3 amphorae, and on-dwelling 2 – 5 amphorae.

In the settlement of Talianki, there are, in most cases, four or one amphorae in each building. "Facial" motifs on amphorae from the settlement of Maidanetske dissolve more and more. This process did not take place abruptly, but evolutionarily, and next to the "faces" that were fully schematized, schemes with archaic features were found, such as black lenticular ovals that replace the "pupils" in the "eyes" of the amphora from the complex "Φ", further preserved four-faced "faces". Between them, in the areas of the handles, 83 different signs are drawn. Of these, 34 graphemes in the form of horizontal lines depicted on the handles (themselves or in blocks); Lenticular ovals (in the form of mono- or polygrams) are drawn 31 times here; 17 polygrams included lunar sickles; Signs in the form of vertical lines or ribbons filled with a grid met 10 times. Observations of the distribution of amphorae with "front" paintings on the dwellings showed that it is to some extent similar to Talianki, although you can see the differences. One amphora was found on four of the 19 dwellings, the material of which was involved in this analysis (set "И", set "Ц", set "Φ", set "O"); 2 amphorae are available at four dwellings (set "Ч", set "E", set "Ю", dwelling 2). Three amphorae were found at each dwelling (set "Ш", 1 set 2); we have four amphorae at four dwellings (set "Я", set 1, set 3, set "I"); five amphorae each occurred at two dwellings (3, 4); 9 amphorae with "frontal" images were found on two dwellings (sets "П" and "C").

In the settlement of Tomashivka (Phase IV of the Tomashivka group) the "front" motif of painting on amphorae is gradually changing and simplifying. From some amphorae, the "eyes" disappear completely, although on others the "four-eyed" "faces" remain. Among the 21 signs that are drawn between the "faces", 13 have the form of horizontal lines on the handles (they were depicted alone or in blocks); 6 polygrams contain crescent moons; there are also 4 lenticular ovals - signs of grain. The "facial" schemes on the vessels of the Tomashivka and Petreny settlements of the last phases of existence persist somewhat longer than in the settlements of the Prut and Dniester interfluvium, location of Kukuyet monuments (Varvarivka XV, Shura I), among which "front" ceramic complexes there are no paintings.

In the east of the Trypillia-Cucuteni oikumene, in the Tomashivka group, the "facial" motifs of the painting disappear with the cessation of the group's existence. The same thing is happening at the stage of the completion of the Petreny type monuments. They are not found on the dishes of later settlements. Thus, the existence of the "facial" motif of painting can be divided into several stages: the first - the emergence and development of the canon in the image of "faces", the second - the widespread distribution of cultural community, almost identical images, which allows them to be called canonical, the third stage - the destruction of the canon, schematization and disappearance of the "facial" motive. The iconic signs depicted between the "faces" are a kind of determinative, i.e. they indicate the range of objects or natural phenomena associated with the creatures whose faces are painted on the dishes. Initially (stages BI-BII, the beginning of BII) these creatures were associated with lenticular signs (grains), graphemes of water, oblique cross full moon sign (?).

At stage BII they were associated with the same signs (crosses, formed lenticular ovals - marks of grain, oblique crosses, lenticular ovals). In the CI-γI stage, the notions associated with “four-eyed” and “two-eyed” creatures are differentiated: in the settlements of the Petersen group, they are associated with the moon and (very rarely) water. The Tomashivka settlements preserve the archaic notions that associated these creatures with the grain. In addition, as in the Petersen group, they were associated with the moon and water (?).

“Owl's face”

This is another type of painted utensils, that depicts the head. With it, biconical amphorae with two handles are usually painted at the stage BII-CI-γI and on round-bodied amphorae at the stage CII-γII.

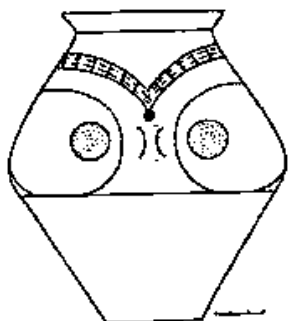

Figure 15

“Owl's face” has two versions of the painting - simple and complex. Both consist of images of four circles - “eyes” on the sides of the handles, two triangles at the bottom between them, and four triangles near the crown. If you look at the amphora from above, these triangles form a rhombus. They differ in the images around the handles - on a “simple” painting around the handles the medallion is most often depicted (Fig. 15), and on the complicated one - a semicircle with large semicircles that depart from it and surround the “eyes” (Fig. 16). Elements that change were painted inside the circles of the “eyes”, sometimes under the handles and in the triangles between the faces under the crowns, as well as in the triangles on their tops between the “eyes”. In the settlement of Volodymyrivka, one “owl face” was found only at two dwellings (dwelling 2, excavations in 1940; dwelling 2, excavations in 1947). The triangles here show black circles - signs of the full moon. One amphora with an “owl face” is on dwelling 1 of the Pischana settlement. The “eyes” on these early “faces” are not filled (Fig. 17).

Most often, amphorae are painted with “owl faces” and are found in the monuments of the CI-γI stage of the Petreny group (Petreny, Bernashivka, Glavan I). Observation of the distribution of amphorae with such paintings showed that in the settlement of Bernashivka their number on the dwellings is equal to two such vessels on the dwelling 4; three - at dwelling 6 and 7; five - on dwelling 5; eight - on areas 1 and 2; nine - on dwelling 3. On dwelling 1 of the settlement Glavan I there are 10 amphorae with “owl faces” (Bykbaev V. M., 1992., p. 108).

“Owl faces” in these settlements have in most cases a complicated scheme of the painting. At the stage of CI-γI, it is possible to observe a certain constancy in their paintings. It is noticeable both at the level of diagrams and at the level of signs that were drawn on them. They consist of ladders (Chapter I) (Markevich V. I., 1985., p. 85., Fig. 83); vertical wavy lines in triangles near the crown (Bernashivka). Signs of animals (Petreny) and months (Bernashivka) were sometimes painted here. Signs of crosses, black or red circles were depicted in “eye” circles. In addition, the “eyes” were sometimes filled with red paint or black hemispheres. Zoomorphic and anthropomorphic images were once painted near the “eyes”, but most often the crescents of the moon were located here.

The number of amphorae with “owl faces” varies in the later settlements of the Petreny group. Two amphorae were found at dwelling 2 of the Lipchany settlement, but none at dwelling 1. The “eyes” of one amphora depict the signs of the lunar crescents in the first and last quarters, which is a vivid illustration

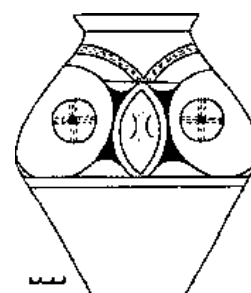

Figure 16

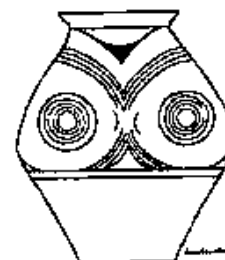

Figure 17

of the idea of the moon as the eyes of a mythical creature. The “eyes” of the second amphora are filled with straight crosses, as shown in the section on semantic markers - the signs of the full moon.

In the more eastern settlement of Stina IV, excavation III found 5 amphorae painted with simplified “owl faces”. In the upper tiers of this vessel were depicted signs that were painted in these areas in earlier settlements - ladder, moon, animals. In addition, there is a W-shaped sign, not typical of Chechelnyk sign systems, but it is found in the paintings of Cucuteni monuments (Varvarivka XV, Shura I). Among the dishes of the Tomashivka group, “owl faces” are much rarer. In the settlement of Talianki, we have one such vessel only on dwellings 15 and 17. Inside them, between the triangles, there are either lunar crescents or a sign of the full moon. An “imported” amphora with an “owl face”, possibly from Chechelnyk monuments, was found in the “Ж” complex (on dwelling 2).

There are also few “ceramic owl faces” among the ceramic complexes of the Chechelnyk group. They were not found in the settlement of Cherkasiv Sad II, and among the vessels from the settlement of Chechelnyk, we have fragments of three such vessels. One amphora with an “owl face” comes from the excavations of the settlement of the Chechelnyk group. The small number of “owl faces” in the Chechelnyk and Tomashivka settlements may be explained by the traditions that to some extent underlie the emergence of these groups, namely the iconic systems of the settlements of Upper Dniester and Prut because the masters of this region did not paint „owl faces”. Neither at the stage BII (settlement Nezvysko III, Konovka) (Shmagliy M. M., Ryzhov S. M., Dudkin V. P., 1985., p. 51) nor the Stage CI (Shipintsi B and Bilche Zolote Park III).

In the Kukuyet settlements, “owl faces” are strongly transformed. On the one hand, their schemes are greatly simplified, in their triangles, there are signs of a snake-water (Shura I) (Bykbasv V. M., 1989., p. 56. Fig. 3, 9). On the other hand, they continue the traditions of previous monuments. Thus, in the upper part of the amphora with an “owl's face” under the crown is depicted a procession of bulls (Markevich V. I., 1985., p. 90., Fig. 92). On another amphora, vertical wavy ribbons are drawn (Markevich V. I., 1981., p. 21, Fig. 32, 9). Inside the “eyes” are either oblique crosses, or they are empty. On one amphora next to them are depicted lunar sickles (Varvarivka XV). In total, there are 6 amphorae with “owl faces” on-dwelling 1 of Varvarivka XV.

In the settlements of the Bădragii type, next to the “eyes” filled with straight crosses, in one case the sickles of the moon with the sign of the snake-water (Bădragii Vechi) are depicted (Fig. 18). The faces themselves begin to be sketched, on one of them the “eyes” are decorated in the form of lenticular ovals. There are 5 amphorae with “owl faces” on-dwelling 1 of Bădragii Vechi. Three of the five “owl faces” from Hancăuți I show moon signs next to the “eyes”. In one case, red crescents of the moon are drawn in the “eye” area. The horns of the two crescents of the moon end in black circles. On another amphora, the “eyes” are filled with crosses and flanked by the crescents of the moon in the first and last quarters, next to them are depicted W-shaped signs. “Eyes” of one amphora are drawn in the form of ovals with two horizontal wavy ribbons -signs of water in each of them.



Figure 18

At two dwellings (№1 and №3 of 1986 excavations) there is one amphora with "owl faces", and at dwelling №2 they were found 3. "Owl faces" from the settlement of Konovka (dwelling 1,2) are very altered. On one amphora instead of "eyes" depicts red spirals with lines flanked by the crescents of the moon in the first

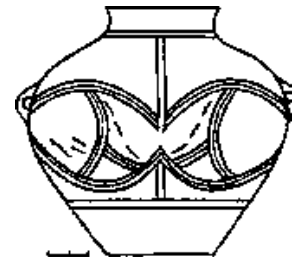

Figure 19

and last quarters. Another amphora in the "eye" area depicts lunar crescents. Only on two dwellings Konovka with two amphorae with "owl faces".

There are no "owl faces" among the ceramic complexes from the settlements of Upper Dniester and Prut basin. In settlements such as Brynzeny III - Zhvanets, the "eyes" of almost all "owl faces" (19 specimens) are decorated in the form of lenticular ovals. Only one amphora has "eyes" painted in the form of red circles. The amphorae from the Ofatinți cemetery in the oval's "eyes" depict the signs of the water snake (Figs. 19, 20). Of the three amphorae with "owl faces", two were in the burials of children (burials № 23 and 48), and one - in the burial of a man, approximately 40-45 years old (burial №18) (Dergachev V. A., Manzura I. 1991., pp. 26, 31, 25). On the amphorae from the burials of the Usatove cemetery, "owl faces" are most transformed, their "eyes" are filled with red paint, and next to the red lines with black lines are drawn (Fig. 7). One amphora comes from mound 7, burial 4 (Dergachev V. A., Manzura I. V., 1991, p. 97., Fig. 61.6), and the second - from mound 12, where it was placed near the person, buried in the central burial (ibid., p. 103., Fig. 65, 1). Another amphora comes from the same mound 12 (ibid. p. 106., Figs. 67, 8). The amphora, which was found in the central burial of mound 13, was located near the head of the right skeleton (ibid. p. 108., Figs. 69, 4).

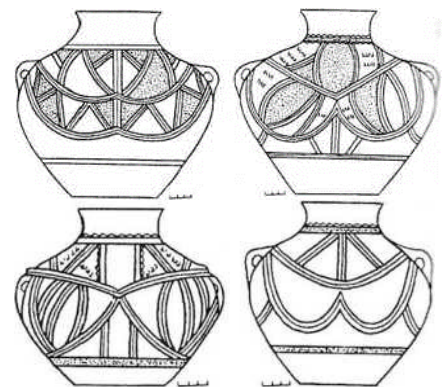

Figure 20

There are no amphorae with "owl faces" among the dishes of later Gordinești monuments. There are several stages in the existence of "owl faces". The first is the beginning of the formation of this painting, which remains a mystery. In the settlements of the east of the Trypillia-Cucuteni oikumene of the Volodymyrivka and Pischana stages, a small number of them look like a simple scheme. In the north-west of the cultural community, there are no such schemes on the Nezvyisko PI tableware. They are absent in later settlements of the Shipintsi subgroup. Thus, it can be assumed that the formation of the "owl face" took place in the settlements of stage BII, which became the genetic basis of the Petreny group. The second stage (beginning and middle of CI-γI) of the existence of the "owl face" can be associated with the widespread use of this scheme on the dishes of the Petreny group. In other local groups, their number is insignificant. Schemes have both simple and complex appearance. The creatures themselves, whose "faces" are painted on the dishes, judging by the signs-icons depicted on them, were most often associated with the moon, less often with animals and water. Moreover, the "eyes" of these creatures were in the minds of the population of that time and the moon.

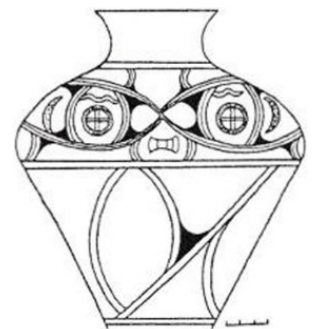

Figure 21

At the end of the CI-γI stage (recall that at this time there is a disappearance of “front” paintings). There is a certain transformation of “owl faces”. Snake-water signs appear near their eyes next to the crescent moons. The eyes themselves gradually acquire a lenticular appearance. At the end of the third stage of development of “owl faces” (CII-γII), their eyes are either empty or have inside the signs of a snake-water. Also, they are filled with red paint.

Anthropomorphic tableware without a “head”

This is also a very archaic type of anthropomorphic pottery, which has its origins in the traditions of the Neolithic cultures of the Balkan Peninsula. In our case, the analyzed type of utensils with anthropomorphic features continues the tradition of earlier monuments of stage BI, where it has a relatively realistic look: it depicts a standing figure of a woman without a head. At the stage of BI, this vessel changes greatly and the signs of anthropomorphization are only a pair of stickers that mimic the breast, under the crown (these pairs of stickers on the vessel are two, rarely four).

For the first time, we have dishes of this type on our material in the settlement of the BI Volodymyrivka stage. One such vessel was found at dwelling 3 from the 1940 excavations, and two at dwelling 2 from the 1947 excavations. They are painted with 8-shaped arches with an interception in the form of inclined ribbons. The location of the arches relative to the “chest” stickers has two options. The first 8-shaped arc is located under the stickers, on the “belly”, in the second 8-shaped arches are depicted as if from the “sides”, and the stickers themselves are included in the B-shaped ends of the arches.

In the settlements of the Petreny group of the CI-γI stage, anthropomorphic vessels in the form of a body without a “head” were used more often. In Bernashivka they are on five of the 7 excavated dwellings. He is not present at dwelling 1; on-dwelling 2 - two such vessels; on the dwelling 3-1; on-dwelling 4 they are not present; on the dwelling 5-3; on the dwelling 6-1; at dwelling 7 there is also one vessel with paired stuck 'chest “under the crown.

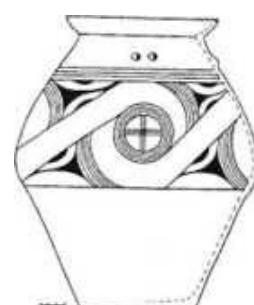

Figure 22

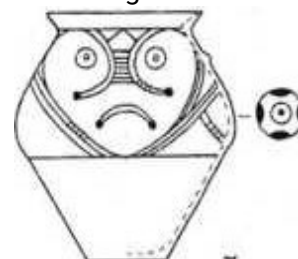

Figure 23



Figure 24



Figure 25

This vessel was painted with the diagrams “Tangentenkreisband” (Fig. 22, 23) and 8-shaped arcs (Fig. 24). The painting was applied in such a way that the medallions with two black hemispheres, crosses (in the schemes “Tangentenkreisband”) and signs in the form of a crescent moon (on an 8-shaped arch) were located under the stickers and on the sides, the largest extension of the torso - “belly”. In the settlement of Lipchany, we have anthropomorphic vessels without a head on one vessel from two excavated dwellings. The schemes of his painting differ from Bernashivka. From dwelling 1 comes a large biconical vessel, the sticking of the “chest” of which is surrounded by curved ribbons, ending in black circles. On the “belly” is an arcuate figure, which ends with black circles - the signs of the moon (Fig. 25). On the second anthropomorphic vessel (from dwelling 2) under a pair of stickers- “chest” is drawn two rows of lines signs of falling water (?).

On the biconical vessel from Varvarivka VIII, the "chest" protrusion is surrounded by circles, and below them, there are two black circles with lines - astral signs of the full moon or sun (?). On its 'sides' heads raised to these signs (Markevich V. I., 1981 p., 25., Fig. 24,14; p. 29., Fig. 29,2) (Fig. 26). In the settlement of Stina IV, we have two anthropomorphic vessels with pairs of "chest" stickers. They are painted with "Tangentenkreisband" schemes. The signs in the medallions were placed under the stickers on the "belly". In one case, the medallion depicts two hemispheres, in the other - a straight cross; medallions, in this case, are combined with the crescents of the moon (Fig. 27). Anthropomorphic vessels without a "head" in the settlements of the II phase of the Tomashivka group are painted in three schemes: 8-shaped arches on the "sides" of the vessel (Stara Buda, Sushkivka); moon-shaped figures under the "chest" protrusions and, sometimes, vertical ribbons between them (Stara Buda); as well as a combination of two schemes of 8-shaped arches with an interception in the lower tier and volute painting - in the second (Dobrovody). In the settlement of Talianki, anthropomorphic vessels have been found on 13 of the 19 dwellings, the material of which is involved in the analysis. One such vessel was found in 9 of them (dwellings 3, 5, 6, 8-10, 14, 17,19); on three dwellings - two anthropomorphic vessels without a "head" (dwellings 2, 20, 21); on-dwelling 13 we have 5 such vessels.

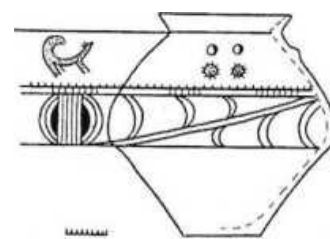

Figure 26



Figure 27

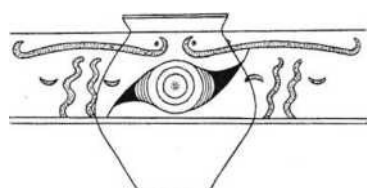

Figure 28

This vessel in comparison with earlier (phase II) is very seldom painted by an 8-shaped arch (only one such vessel from a dwelling 8 is found). The most commonly used scheme of painting, which consisted of moon signs under the stickers - "chest" and tangents that connected the two and images (dwellings 2, 5, 6, 13, 17, 19-21). At all dwellings (11), except one, one anthropomorphic vessel without a "head" was

found, which are painted by this scheme, while on-dwelling 3 we have 3 such vessels. In addition to this scheme, anthropomorphic vessels without a "head" were often painted with a currency scheme. We have 7 such vessels (dwellings 5, 9, 10, 13, 14, 21). At all these "dwellings", except 13, one vessel painted by this scheme was found. There are two of them on the dwelling. In most cases, black circles (once the crescents of the moon, which replace it) were placed on the "sides" of the dishes, and the sticking "chest" is part of the W-shaped end of the currency compositions. Only once a black circle surrounded by volutes is depicted on the "belly" under the protrusions- "chest".

There are no black circles among the ceramic complex of anthropomorphic utensils without "heads" from Maidanetske which, are painted with 8-shaped arcs and moons under the protrusions-"chest". There are only currency schemes in their painting. Black circles, in most cases, are located under the protrusions-"chest", although their images are preserved on the "sides" (in relation to the stickers). At the "dwellings" they occur much less frequently than in Talianki. Thus, of the 19

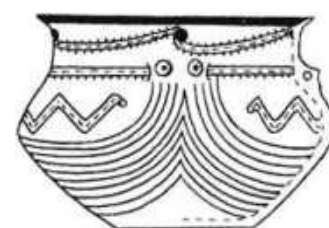

Figure 29

complexes, the material of which was involved in the analysis, they were found only on six (on the complex "Ш" - 4 vessels; on the complex "Я" - 3; on the complex "П" - 3; on the dwelling "E" - 1; on-dwelling 2 - 1, on-dwelling 3 of the complex "Ф" - 1 vessel. There are no such dishes on the ware of phase IV (from

the settlement of Tomashivka). Two anthropomorphic vessels without "heads" were found on one excavated dwelling of the Chechelnyk settlement. Two rows of lines are drawn near the "chest" stickers of one of them. Signs of falling water (?), vertical signs of the snake-water, are flanked by the crescents of the moon. Above these compositions are depicted signs in the form of bucranium (?) so that the horns surround the ends of the "chest" protrusion (Fig. 28).

At the end of the Cl-yl stage, anthropomorphic vessels without "heads" gradually disappear. Fragments of three such vessels were found in the settlement of Varvarivka XV. And among the dishes from Bădragii Vechi on dwelling 1, only one anthropomorphic vessel without a "head" with four pairs of "chest" stickers was found. It is painted with vertical ribbons filled with oblique crosses and flanked by black vertical semi-shafts. These signs were located under the "chest", and they were flanked by red signs of a snake - water.

An anthropomorphic vessel from Târgu Ocna-Podei is also connected with the signs of the snake-water. Paired stickers - "chest" here are located on the handles, and on the sides, are surrounded by W-shaped signs of the snake - water (Fig. 29). In later settlements, such anthropomorphic utensils do not seem to exist. Thus, the vessel, the anthropomorphic features of which are two or four pairs of stickers under the crowns that mimic the chest, continues the tradition of depicting figures without heads. The location on their "bellies" and "sides" of the signs of the full moon or its crescents may illustrate the mythology of the birth of the moon by some female beings. And the absence of the head probably indicates some cosmic sacrifice, thanks to which all objects and phenomena related to the moon's appearance.

Unique anthropomorphic schemes

In addition to the widespread types of anthropomorphic vessels, in some settlements (and possibly on “dwellings”) we have single schemes, which are characterized by anthropomorphic features. Among the ceramic complex from Konovka on dwelling 3, an anthropomorphic vessel was found, the nose of which was modeled with a handle, and the “eyes” with large negative circles.

Another anthropomorphic scheme is drawn on a cup with a handle, which originates from a settlement of the Volodymyrivka or Nebelivka group. It has the form of two “eyes” - vertical ovals with negative bands inside (water signs). The handle of the cup simulates the nose, and below it, there is an open “mouth” with vertical lines (possibly signs of falling water?). Another unique anthropomorphic “face” is depicted on the crater from the settlement of Talianki (dwelling 5). The “eyes” are decorated in the form of two horizontal crescents of the moon with horns upwards, from which depart ribbons filled with a grid, the “nose” of the “face” is also modeled with a handle, and below it, a “mouth” of a crescent moon with a wide vertical ribbon filled with a grid is depicted. Finds of these single anthropomorphic vessels, which originate from individual dwellings of settlements, indicate that, in addition to general ideas about anthropomorphic creatures (as evidenced by their identical iconography), there were some, possibly related ideas about them.

Anthropomorphic images (signs)

This is another type of anthropomorphic images, to which a lot of space is devoted in the literature about the worldview of the Trypillia-Cucuteni population. In the last major work on this topic, Movsha systematized and classified bitriangular images, as well as other signs, according to the researcher, related elements (Movsha T. G., 1991, pp. 34-47., Fig. 1, 2). In this small section, we will pay attention to the syntagmatic and paradigmatic series of signs, their possible binary modeling, as well as the gestures of their “hands” in connection with the morphology of the general schemes of painting dishes. At the stage of BII and CI-γI, bitriangular anthropomorphic images have not yet been found. However, there is another type of them in the settlements of the Petreny group. Thus, from the eponymous settlement comes the famous image of two four-armed creatures surrounded by medallions with crosses on a pear-shaped vessel (Stern E. R., 1906., Table 11.3):



shaped vessel (Stern E. R., 1906., Table 11.3):

At dwelling 3 of the Bernashivka settlement, there are two anthropomorphic images on an amphora with an “owl face” that is similar in style to the Petreny ones. They, in contrast to the Petreny ones, have two arms each and are as if on piles, the sharp ends of which extend downwards, beyond the ornamental

field: 

There are doubts about the appearance of triangular images on the Coquette stage (Varvarivka XV). According to Bikbayev, they come from another (Brynzeny) layer of the settlement, where such images are quite common. Thus, triangular anthropomorphic figures, as far as is now known, appear only on the ceramics of monuments such as Brynzeny III - Zhvanets, the study of which is devoted to most of the

already mentioned work by Movsha: 

Consider anthropomorphic images in the light of the binary hypothesis. On two vessels from Brynzeny III (Markevich V. I., 1981., p. 43., Fig. 59), anthropomorphic figures are drawn in the lower, first tiers of the painting. On two of the four festoons depicted in the first tier of one vessel, in addition to ovals with rows of W-shaped signs, on the left is an anthropomorphic figure, and on the right - a vertical row of triangles (equivalents of the sign of the snake-water). On the second tier of the painting of this vessel, there are no anthropomorphic figures, and in the ovals, there are W-shaped signs (also equivalent to the sign of the water snake). On the second vessel in the first tier are depicted only anthropomorphic figures, in the second, in addition to them, are painted bovid and the equivalent of the sign of the snake - water: horizontal rows of red rhombi. On another vessel of this time, from Costești IV (Markevich V. I., 1981. p. 48., Fig. 72, 1), unfortunately, only the upper tier has survived. It depicts animals in ovals flanking rows of red vertical rhombi with circles (equivalent to the sign of the snake - water), next to them depicts, in one case, an anthropomorphic creature surrounded by animals, and in another - without animals. Thus, it can be seen that the anthropomorphic figures on this vessel are associated with the signs of the snake-water, and in this case, they were depicted in the first tier, marking the bottom. When they appear, pictures of animals appear at the top.

The fact that anthropomorphic images are very closely related to the signs-icons of the snake-water and their equivalents, as evidenced by the image on a fragment of dishes from Brynzeny III (Markevich V. I., 1981. p. 157., Fig. 103,4), where above two anthropomorphic figures are drawn vertical wavy lines, as well as a fragment of a vessel from Costești IV, in which two anthropomorphic images flank a vertical row of red rhombi - the equivalent of a snake - water (ibid. p. 157., Fig. 103, 3). Also, they were associated with signs in the form of crosses (ibid. p. 157., Fig. 103, 10). Unfortunately, we have not yet been able to get acquainted with the whole sign system of these settlements, and we cannot show all the paradigmatic relations of signs in the form of anthropomorphic images.

Such a study was conducted on the material of the settlement of this time - Zhvanets. Anthropomorphic images on the dishes make up 3.8 % of all known signs. Of the 31 signs depicted in the lower tiers of rounded amphorae, 5 are anthropomorphic. Most often they were replaced by signs of a snake - water or their equivalents (16 times); on vertical tapes - 3 times; on oblique crosses - 3 times; on a vertical row of W-shaped signs - 1 time; on signs-icons of plants - 2 times; on the astral sign in the form of a red circle - 1 time. In the upper tier of this vessel, where we have 15 signs, one is anthropomorphic. It is also often replaced by signs of a snake-water (10 times); on a sign in the form of parallel lines - 2 times; a vertical row of M- and W-shaped signs - 1 time; per animal - 1 time. Thus, the paradigmatic series of anthropomorphic images confirm their connection with snakes and water. The arms of bitriangular anthropomorphic figures are depicted either statically raised or lowered, or dynamically when one arm, often the left, is raised to the head and the right is lowered to the waist. Thus, the gestures of the figures convey statics and dynamics.

Painting schemes also form static and dynamic compositions or combinations thereof. Based on this, we can assume that the gestures of the hands of anthropomorphic images and static or static-dynamic compositions are based on the same ideas, perhaps schemes of ritual actions or cosmogonic representations. Anthropomorphic images on the dishes of the Gordinești group were painted very rarely and they have a different iconography. Thus, an anthropomorphic figure is painted red on a high cylindrical neck on the amphora from the Gordinești layer of the settlement of Hancăuți I, which is painted with a "parquet" ornament., p. 150., Fig. 1, 1), which is completely different from ventricular images.

Image of the moon on the schemes of painting

Lunar and anthropomorphic images have two manifestations - small variable icons - icons in the form of crescents of the moon and black circles and schemes of paintings, which included images of the moon and which, unlike small signs, cannot be removed without violating the whole scheme. The upper projection on the dishes of the Volodymyrivka, Nebelivka, Petreny, Tomashiv, and Shipintsi groups allows us to notice on some of them the schemes, the elements of which in the form of moons form two main compositions. The first has the appearance of two crescents of the moon (often negative), which flank the neck of the vessel. Thus, a picture of the lunar cycle is formed: the moon in the first quarter (crescent horns to the left) - the full moon (neck of the vessel) - the last quarter (crescent moon to the right) (composition 1).

The second consists of four crescents of the moon, which are cruciformly arranged around the neck of the vessel (composition 2). There are no months from the settlements of the Rakovets group on the utensil diagrams of the beginning of the Middle Dniester BI stage. They did not occur in later schemes of dishes of the settlements of the Upper Dniester Nezvysko III and the Middle Bug Basin - Voroshyivka. Instead, in the settlement of this time (mid-BII) Volodymyrivka, lunar elements were included in the paintings of dishes quite often. Composition 1 is on cups (2 samples), on biconical dishes (15 samples), and pear-shaped dishes (4 samples). Composition 2 is observed on pear-shaped (4 samples) and biconical vessels (18 samples). Composition 1 is depicted on only one biconical vessel on the vessels of the settlement of the Nebelivka group of the 1st phase. In all other cases of occurrence of elements in the form of months to schemes of a list, they form compositions 2 on biconical ware (4 samples). On the utensils from the settlement of phase II Kolodyste schemes with months a little less. Composition 1 is depicted on a biconical vessel, composition 2 - on a biconical and pear-shaped vessel (4 samples). Negative crescent moons are drawn on the cover of the pear-shaped vessel.

Utensils from the settlement of the end of the BI stage of the Middle Dniester Konovka have very few schemes with months. Composition 1 is drawn in a crater-like vessel. On the lid of a pear-shaped vessel, the negative lunar crescents are located by the horns from the center, thus, the center of the lid in the form of an empty circle falls on the new moon (composition 3). There are more painting schemes with elements in the form of months on the dishes of the Bernashivka settlement of the CI-γI stage of the same region. Composition 1 is depicted on a biconical vessel and the lids of a pear-shaped vessel (4 samples). Composition 2 is painted on biconical and pear-shaped utensils much more often (161 samples). In addition to these compositions, the negative crescents of the moon are depicted on a bowl painted with four large lenticular ovals and scallops (composition 4).

In the settlement of Petreny, there are fewer dishes with schemes, the elements of which are similar to the crescents of the moon. Composition 1 does not exist here, and composition 2 was formed on pear-shaped and biconical vessels (20 specimens). In the Upper Prut and Dniester at the beginning of CI-γI schemes with lunar elements are few. In Shipintsi B we have compositions 2 and 3 (9 samples). There are no such schemes on the published dishes from Bilche Zolote Park III. In Middle Dniester, there are also a few of them in the dishes from the settlement of the middle of CI Lipchany. Compositions 1 are depicted on biconical and cup-shaped vessels. Composition 2 is depicted on a cup-shaped vessel. Here we also have an increased number of negative crescents around the neck of the biconical vessel, where they are not 4 but 8 (composition 5).

In the settlement of the last phase of the Chechelnyk group's existence, Stina IV, the painting schemes with elements in the form of crescents of the moon almost entirely belong to the images on the Chechelnyk vessels. These are segmental paintings of bowls (composition 6) and compositions 2, formed by festoon schemes of a painting of the second tier of biconical ware (10 samples). It seems that only one scheme of the "facial" amphora, which is painted with lunar crescents (composition 1), has a Petreny look.

To describe the schemes with elements in the form of lunar crescents in the Tomashivka group, let us go back a little to the beginning of the CI stage. In the settlement of Sushkivka, compositions 1 are depicted on cups (2 samples), on biconical dishes (9 samples), on pear-shaped dishes (2 samples). Compositions 2 were painted on a biconical vessel (24 samples). Also, we have a slightly modified composition 2, which consists of three negative sickles around the crown, instead of four (composition 7). On the biconical vessel with a tangent painting, there are two handles, in the zones of which there were variable small signs, flanked by two negative vertical crescent moons. Thus, the schemes of the lunar cycle were formed: the moon in the first quarter (right sickle with horns to the left) - full moon (handle, or the area where the variable graphemes were located) - the moon in the last quarter (left sickle with horns to the right) (composition 8). On the dishes from the settlement of Chicherkozivka compositions, 1 is formed on cups (4 samples). Compositions 2 are painted on pear-shaped (7 samples) and biconical dishes (4 samples).

Composition 8 on the dishes more than in Sushkivka. They are depicted on the pot and biconical utensils (5 samples). Dobrovody tableware schemes of painting, which have elements in the form of crescents of the moon and which make up composition 1, are depicted on cups (2 samples) and biconical dishes (22 samples). Composition 2 is depicted on pots, on biconical utensils (5 samples). On one biconical vessel is a composition 7. Compositions 8 are formed on a biconical vessel (3 samples). Also, here we have a diagram that is a cruciform zone, which depicted small variable signs flanked by the crescents of the moon (composition 9). Schemes of painting dishes of the settlements of the III phase of the Tomashivka group of Taliianki and Maidanetske most vividly demonstrate the elements in the form of crescents of the moon. In Taliianki these compositions 12. Compositions 1 were most often painted on cups, biconical and pear-shaped utensils - a total of 109 utensils. Composition 8 is on 42 schemes of painting biconical vessels and craters. Compositions 2 are formed on 30 schemes of painting biconical and pear-shaped utensils, pots, and craters.

Compositions 10 are a combination of compositions 1, from which the flanking of the neck of the vessel is taken by two crescents of the moon, and composition 8, from which the flanking of vertical lunar crescents of the handles or free fields, where the variable signs were located. They are depicted in 26 schemes of painting biconical vessels and craters.

Compositions 11 are formed by combining composition 2 and composition 8, which are depicted on a biconical vessel (2 samples). The composition, which consists of cruciform zones with variable small signs flanked by the moon, is drawn on the crater.

Composition 12 has the form of twelve lunar sickles (two in each pair), which are drawn around the neck of a small biconical vessel.

Composition 13 is created by vertical lunar sickles flanking each of the four ovals on a biconical vessel.

Composition 14 consists of negative vertical moons flanking each of the four black circles, and larger sickles surrounding the neck of the biconical vessel.

Composition 15 has the form of negative lunar crescents flanked by two large black circles located on two opposite sides of the biconical vessel.

Composition 16 looks like flanking two large black circles located on two opposite sides of the vessel with negative lunar crescents and each of the two large black circles drawn perpendicular to them.

Composition 17 has the form of combining composition 2 and composition 8 in one tier of painting a biconical vessel. In Maidanetske we also have 12 paintings, which consist of elements in the form of crescents of the moon. Composition 1, as well as in Taliانki, dominates. They are depicted in 138 schemes of painting cups and biconical utensils.

Compositions 10 are depicted in 75 diagrams of biconical utensils. Compositions 8 were also placed on a biconical vessel (31 times). Compositions 2 are created on the schemes of paintings of pots, biconical and pear-shaped utensils 27 times. Besides, these compositions are on 9 other Chechelnyk "imports" found in this settlement.

Compositions 15 are painted on a biconical dish 8 times.

Composition 18 is not on the dishes from Taliانki. It is a flanking of two double ovals with negative lunar crescents depicted on a biconical vessel (4 copies).

Composition 19 is also new. It is drawn on bowls, on the edges of two arcs, which go one behind the other and depict lunar crescents filled with a grid (3 copies). Compositions 19 are arranged on two pear-shaped vessels (2 copies).

Composition 20 is an image of the sign of the grain in the center of the bowl and four lunar crescents filled with a grid extending from its sharp ends.

Composition 21 consists of combining two compositions - 1 and 15 in one tier of the painting.

Compositions 6 have the form of two or four segments, divided into crescents of the moon, which are depicted on "imported" beehive bowls (9 copies).

On the dishes from Talne II, we have only 3 compositions with elements in the form of crescents of the moon. Composition 1 is depicted 11 times on cups and biconical utensils. Compositions 10 are located on a biconical vessel (3 samples). Composition 2 is also depicted on a biconical vessel. In the eponymous settlement of the last, IV phase of the existence of the Tomashivka group, compositions 1 are formed on the schemes of painting cups and biconical vessels (29 samples), as well as on the "imported" Chechelnyk (?) vessel. Composition 2 is depicted on pots, biconical and pear-shaped utensils (7 samples), composition 15 is also depicted on biconical utensils (2 copies). Also, there is another composition 22, which consists of flanked by the crescents of the moon four large black circles.

In the settlement of the Dniester and the Southern Bug interfluvium of Cherkasiv Sad II bowls are painted with two moon-shaped segments (13 samples); similar paintings are on the bowls of the settlement of the Chechelnyk group Stina IV and the Tomashiv settlement of Maidanetske (composition 6). On the biconical vessel, which was painted with wavy ribbons, the medallions that filled the upper and lower tiers of the painting were often flanked by moon sickles with wavy ribbons extending from their centers (24

samples) (composition 23). Compositions 2 (36 samples) were used quite often. Similar compositions are on the schemes of painting the dishes of the settlement Chechelnyk. Compositions 6 are drawn on bowls (7 samples). Composition 23 is depicted on a pear-shaped and biconical vessel (32 samples). Composition 2 - on pear-shaped and biconical utensils (50 samples).

On the dishes of the settlement of the Right Bank of the Prut in the middle of the CI-γI stage Valea Lupului II composition 5, which first appeared on our material on the dishes of the settlement of Lipchany, has the appearance of lunar sickles surrounding the second tiers of biconical dishes (7 samples). Also, here is composition 2 in the form of four negative sickles, which also surround the second tier of the painting. In Upper Dniester, in Bilche Zolote Vertebe, the cover of a pear-shaped vessel depicts composition 1, where two crescents flank a circle with a red cross inside. There are almost no schemes with elements in the form of moons on the dishes of the settlement of Varvarivka XV, except for composition 1, which is depicted on a small vessel. We have more schemes with such elements on the dishes with a monument of the Bădragii Vechi. In Bădragii it is composition 5 (9 samples). In Hancăuți I, compositions 5 are also depicted on amphorae (11 specimens). Composition 2 is drawn here once. On the dishes from Konovka (dwelling 1,2), two negative moons are depicted in the middle of the bowl, which is painted with a diagram in the form of the number "8".

There are no painting schemes with elements in the form of sickles of the moon on the dishes of the settlements of Podei-Târgu Ocna and Koshylivtsi Oboz. There are very few such schemes in the monuments of the CII-γII stage. Thus, in Zhvanets only three negative moons are depicted inside one cut-spherical bowl. In Ofatinți compositions, 2 are formed on pots (2 samples). There are no burials in Usatove dishes with monthly paintings. Instead, in the Majaky, one-pot depicts two crescents of the moon flanking its neck (composition 1). The same painting is on the pot of burial of the Usatove type of Krasnohorka. As we can see, the schemes of painting with elements in the form of crescents of the moon within the BI stage were used only on the dishes of the settlements of the Bug and Dniro Interfluvium - Volodymyrivka, Pischana, and Kolodyste. At the end of the BI stage, they are in very small quantities on the dishes of Konovka (Middle Dniester).

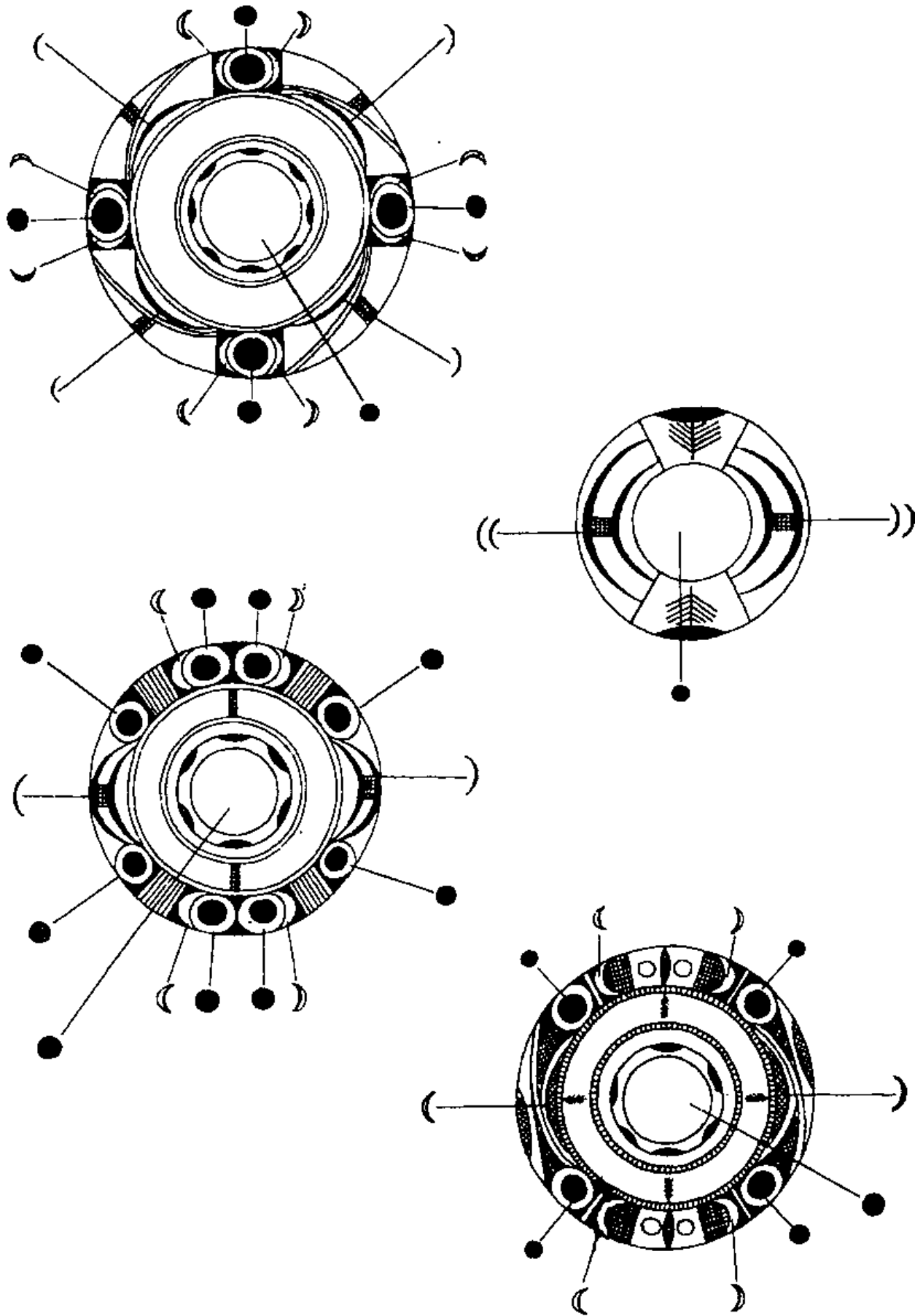

Figure 30: Monthly coding on biconical utensils and a cup from Tomashivka settlements

At the CI-γI stage, such elements were very often included in the schemes of painting the dishes of the Tomashivka group, less often they were used in the schemes of the Chechelnyk, Petreny, and Shipintsi groups. At the end of the CI-γI stage, the number of uses of schemes with elements in the form of crescents of the moon decreases sharply, and at the CII-γII stage, it becomes very insignificant. The depiction of these diagrams was probably caused by the notion that the rise and fall of the moon were associated with the filling and diminution of what was inside the vessel. The full moon was thus equal to a full vessel. In the light of the lunar coding, the lunar flanking of medallions on the dishes of Chechelnyk settlements and handles, or free zones on the Tomashivka dishes, where various variable signs were located, are perceived as signs associated with the full moon. Images of lunar crescents on the sides of large black circles on the dishes of the Tomashivka group point to them as signs of the full moon.

The elements of the painting in the form of crescents of the moon are included in cross-shaped and swastika-like compositions, which once again testifies to the close connection between the sign-icon of the moon and signs-symbols of the cross and swastika, as well as their associations in the population of Trypillia-Cucuteni community.

PRAGMATICS OF TRYPILLIA-CUCUTENI SIGN SYSTEMS

Dynamics of the use of basic characters (basic semantic markers)

Did the population of Trypillia-Cucuteni settlements perceive the analyzed images as signs? This is one of the main issues of pragmatic research. It must be answered by synchronous and diachronic studies of the uses of the basic core of sign systems - basic semantic markers - both themselves and in polygrams.

Signs of the moon - black (red) circles and sickles

Observations on the use of the full moon sign allow the researchers to see, that it was most often used in the sign systems of the settlements of the far east of the Trypillia-Cucuteni oikumene (see: Table 1. Volodymyrivka, 28 % of all signs; Pischana – 25 %). In the dishes of the settlements from which the outflow of the population took place, the black circle was not used often (see: Table 6. Nezvysko III, 6 %). On the utensils of a later settlement, which was in the zone of contact of two traditions of painting - Petreny and Shipintsi, the black circle is again used very often (see: Table 7. Konovka, 22 %). Thus, the use of the sign of the full moon at the BI stage indexes the location of the society that used it, in some tense conditions, associated with contacts with other populations, some recent migrations, being in new lands, and so on.

In the east of the Trypillia-Cucuteni oikumene, starting from the II phase of the Nebelivka group (see: table I. Kolodyste, 16 %) to the II phase of the Tomashiv group (see: table II. Sushkivka, 10 %; Chicherkozivka, 6 %; Dobrovody, 17 %), there is, on the one hand, a sharp decline in the use of the full moon sign, which can be explained by a certain stabilization of life of the population of this region. On the other hand, significant use of a different moon sign - in the form of a sickle. At this time, in the sign systems of the Shipintsi group, significant use of the full moon sign is noticeable (see: Table 6. Shipintsi B, 14 %; Bilche Zolote Park III, 12 %). It is also often used on the dishes of the eponymous settlement of the Petreny group (see: Table 7, Petreny, 14 %). In the sign system of the more northern settlement of this group Bernashivka (see Table 7, 13 %) the image of black circles is quite moderate and the considerable use of signs in the form of crescents of the moon can be explained by a common basis for the formation of the Petreny and Shipintsi groups.

It should be noted that the frequency of use of these signs in relation to the sign systems of early monuments (eg: Nezvysko III, 6 %) is high, and in general, the use of the full moon sign here is approximately the same as the eastern sign systems (Tomashivka group). There are few images of black circles and sickles in the sign systems of the early phases of the Chechelnyk group (see Table 4, Cherkasy Garden II, 8 %; Chechelnyk, 3 %). In the third phase of the Tomashivka group, there is again a short-term increase in the use of the black circle in the sign system of Maidanetske (see Table 3. - 22 %). The same can be seen in the symbolic systems of the Petreny and Chechelnyk groups (see Table 8. Lipchany, 22 %; Stina IV, 15 %). These growths can be explained by the general reaction of the bearers of the cultural community at the beginning of the crisis, which eventually led to the disappearance of the Tomashivka and the strong transformation of the Petreny groups. At this time in Bilche Zolote Verteba I (see Table 9.5 %) black circles are drawn less often, but very often depict signs in the form of a crescent moon.

In the sign systems of the settlements between the Prut and Dniester rivers, the gradual disappearance of moon signs in the form of black circles and sickles is noticeable at the end of the CI-γI stage (see Table

10. Bădragii Vechi, 4 %; Hancăuți I, 3 %). Only on the periphery of the cultural community at this time are these signs of the moon preserved. In the sign system of the Upper Dniester settlement Koshylivtsi Oboz (see: Table 11., 15 %) the crescents of the moon were often painted, and in the dishes of the settlement of the far east of the west (right bank of the Seret, Table 24 %). At the stage of CI-γI, these signs of the moon disappear from the sign systems.

Signs of the full moon - medallions with hemispheres (1) and crosses inside (2)

At the BI stage, these signs of the moon were mostly used in the sign systems of the settlements of the Upper Dniester (see Table 6. Nezvysko III, (1) – 9 %, (2) – 7 %). They are rarely depicted in the Bug, and it can be concluded that, at that time, unlike the Black Circle, they were not in great demand in the process of sign-making. Very rarely, which can be explained by the presence in their sign systems of moon signs in the form of a black circle and sickle, but on the painted dishes of the Chechelnyk group moon signs in the form of medallions with hemispheres were used very often (see: Table 4. Cherkasy Garden II, 36 %; Chechelnyk, 49 %). This may be due to the influences of Western traditions, most likely Petreny, at which time the use of medallions with semi-ovals in the sign systems of Shipintsi is sharply increasing (See Table 6., Shipintsi B, 18 %) and Petreny groups (see Table. 7. Bernashivka, 29 %).

Circles with crosses inside in Petreny sign systems, in contrast to the eastern groups (Chechelnyk and Tomashivka), were drawn a little more often (Petreny, Table 7. 5 %; Table 4. Cherkasiv Sad II – 2 %; Chechelnyk – 1 %). Their use became even greater at the end of the CI-γI stage in the symbolic systems of the settlements of the right bank of the Prut (see: Table 8. Valea Lupului II, 8 %), a little later Târgu Ocna-Podei (see: Table 9., 5 %) and the interfluvium of the Prut and Dniester (see: Table 9. Varvarivka XV, 8 %; Bădragii Vechi, 5 %; Hancăuți I, 8 %). This increase may be due to the decrease at this time in the use of other signs of the moon (black circles and sickles) in the sign systems of Bădragii settlements. The almost complete disappearance of these signs from sign systems at the stage of CII-γII is due to global changes in the process acquaintance of this time.

Signs of water - wavy line or ribbon: ribbon filled with parallel horizontal lines, groups of vertically arranged short dashes

Wavy lines or ribbons (assumed signs of flowing water) were most frequently used in these sign systems. Only in the east did the ecumenism (see Table 1. Volodymyrivka, 23 %) and (see Table 1. Pischana, 22 %) prefer to draw another sign of water – a ribbon filled with horizontal lines. The use of these signs reached its apogee here at the end of the BI stage (see Table 1. Kolodyste, 33 %) and the beginning of CI (see Table 2. Sushkivka, 32 %). Further in the use of this sign, there is a certain decline, up to the sign system of the settlement of Taliianki (see: Table 3.2 %), where its use is very insignificant. Perhaps this phenomenon is explained by the largest number of images of another water sign in the environment of the Tomashivka group - in the form of falling drops (groups of vertically arranged short dashes) (Table 2. Sushkivka 5 %, Chicherkozivka 10 %; Table 3, Taliianki 8 %, Maidanetske. Later, the use of tape filled with horizontal lines increases (see Table 3. Maidanetske, 8 %; Talne II, 11 %; Table 7. Tomashivka, 14 %).

In general, the significant use of this sign of water in the sign systems of the Tomashivka group, in comparison with others, may be explained by the conservation in the far east of one of the archaic graphemes of the beginning of BI (Rakovets group). The same applies to the image of signs in the form of “falling water” at the beginning and during the CI stage. At this time, they are often used on painted dishes of the Tomashivka group, but most often - on the dishes of the Chechelnyk group (Table 4. Cherkasiv Sad II 16 %, Chechelnyk 13 %). In other traditions (see: Table 8. Lipchany, 5 %; Stina IV, 4 %) signs of “falling water” were used more often than “pure” Petreny paintings. This phenomenon is especially interesting in Lipchany, where the “falling water” signs may have compensated for the insignificant use of the “flowing water” sign.

Global changes in sign systems at the end of the CI-γI stage also manifested themselves in the use of water signs. Signs in the form of a ribbon filled with horizontal lines, in small numbers remained, perhaps as a relic, on the painted utensils of the settlement of the far west - Târgu Ocna-Podei (see Table 9. 2 %), from all other sign systems of this time they disappeared. Signs of “falling water” are preserved. They were used quite moderately in the dishes of the settlements of Varvarivka XV (see: Table 9. 5 %), Bădragii Vechi (Table, 10, 2 %), Târgu Ocna-Podey (Table 9. 5 %), and the later Mayaky Cemetery. (Table 9. 4 %) The rather stable use of the “flowing water” sign at the beginning and inside CI-γI in the second half of this stage is replaced by a very significant increase in its use. At this time, it is synthesized with the sign of the “snake” (see: Table 8. Valea Lupului II, 45 %; Bilche Zolote Vertebe I, Table 9. 21 %; Varvarivka XV, 24 %; Bădragii Vechi, Table 10. 42 %; Hancăuți I, Table 10. 31 %). This growth reaches its apogee at the stage of γII (see: Ofatinți, Table 11. 54 %; Majaky, Table 12. 42 %; Usatove, 62 %).

The sign of the grain is a lenticular oval

Very archaic signs in the form of lenticular ovals occur at least on the painted vessels of the BI-γII stage (Trajan Dealul Fintinilor, Klishchiv). At the BI stage, they were used very often (Table 6. Nezvysko III 25 %; Table 5, Voroshylivka 22 %; Table 1. Volodymyrivka 14 %). At the CI-γI stage, its rather significant use is observed in two regions of the cultural community: in the far east - in the sign systems of the Tomashivka group and the northwest - in the sign systems of the Shipintsi group (Table 2. Sushkivka 9 %, Chicherkozivka 14 %; Dobrovody 9 %, Table 3, Talianki 17 %, Maidanetske 16 %, Talne II 2 %), which can be considered as a phenomenon of conservation of traditions in BI stage (Table 6. Shipintsi B 17 %).

The insignificant use of this sign on utensils from Konovka (Table 5) may be explained by the influences of Petreny traditions. Signs in the form of lenticular ovals were rarely drawn on Petreny dishes (Table 7. Petreny 1 %; Bernashivka 1 %; Table 8. Lipchany 2 %). These signs live to the end of the culture but are not used often (see: Table 11. Ofatinți, 2 %; Table 12. Majaky, 4 %; burials of the Usatove type, 3 %). Vertical and diagonal lines and ribbons; quadrilaterals;

Vertical strips flanked by vertical hemispheres

This group of signs performs a dual function in ornamental schemes: in addition to denoting certain phenomena and objects, as indicated by their semantic fields, they also served as important elements of meta signs (painting schemes), which created their statics or dynamics.

Preference was given to vertical strips (Figure 35. 22 %) and quadrilaterals (29 %) in the settlement of the middle of the Bug basin, Voroshylivka stage, in contrast to more eastern settlements of the Volodymyrivka type, where diagonal strips were preferred (Figure 31. 14%). This can be explained by some "selection" of sign systems brought from Upper Dniester and whose influences are equally noticeable at this time on the painted dishes of the settlements of interfluvium of the Southern Bug and Dnieper. At that time, quadrangles were relatively often depicted in the sign systems of Upper Dniester (Nezvysko III) (Figure 36. 11 %), and vertical and diagonal stripes or lines were rarely depicted (Figure 36. 4 %; 3 %). At the CI stage, vertical lines and ribbons were very often drawn on the dishes of Chechelnyk monuments (Figure 34. Cherkasiv Sad II 14 %; Chechelnyk 13 %). This may be a tribute to the traditions of the BII stage.

The quite frequent use of quadrilaterals in the sign system Petreny (Figure 37. 8 %) (beginning of CI-γI) and Stina IV (Table 38. 11 %) (end of CI) can be explained by influences from Chechelnyk traditions, where this sign was used very often (Figure 34. Cherkasiv Sad II - 12%; Chechelnyk 14 %). In the east of the cultural community, among the Tomashivka group, quadrilaterals were painted on dishes more and more often (Figure 32. Sushkivka 9 %, Chicherkozivka 8 %; Dobrovody 14 %; Talianki 14 %), while the use of vertical and diagonal ribbons decreased. From this, we can conclude that these signs were gradually replaced by quadrilaterals. However, in this region at the end of the BII in the sign system of Kolodyste settlement, the frequent use of vertical tape flanked by vertical semi-ovals is noticeable (Figure 31. Kolodyste 6 %), and at the beginning of CI in the sign system of Sushkivka, the use of diagonal tapes increases significantly (Figure 32. Sushkivka 15 %).

Later, a similar phenomenon was observed at the other end of the cultural community - in Upper Dniester, on painted dishes from Bilche Zolote Sad II (Figure 36. 25 %). Here this phenomenon continues further and is noticeable at the end of the CI stage in the sign system of Bilche Zolote Verteba I (Figure 39. 33 %). Starting from the middle of the CI-γI stage in the Middle Dniester (Lipchany, Figure 8.2 %) and a little later on the Right Bank of the Prut (Valea Lupului II, Figure 38. 5 %), vertical and diagonal stripes, as well as quadrilaterals, are replaced by quite often used vertical tapes flanked by vertical hemispheres. This phenomenon is most clearly noticeable in the sign systems of the Prut and Dniester interfluvium (Varvarivka XV, Table 9. 18 %). On later dishes they are settlements of the Bădragii type¹ were painted a little less often (Figure 40. Bădragii Vechi 10%; Hancăuți 12 %), except for Konovka (site 1, 2) (Figure 40. 25 %), which is probably explained by the peripheral location of this settlement.

As we have already noted, on the painted utensils of the settlements that were on the periphery, certain signs that are already disappearing in the center of the cultural phenomenon or are close to disappearing. This also applies to the rather frequent use of vertical tapes flanked by vertical semi-shafts in the sign systems of Koshylivtsi Oboz (Figure 41. 9 %) and Târgu Ocna-Podei (Figure 39. 12 %). This sign was very rarely depicted on dishes from the settlement of the Bădragii type Hancăuți I. (Figure 40. 2 %). Here the use of vertical ribbons begins to be observed (Figure 40. Hancăuți I, 17 %), at the monuments of the CII-γII stage it reaches its apogee, and together with the signs of the snake-water, they dominate in the sign

systems of this time (Zhvanets, Figure 41) 38 %; Ofatinți, 42 %; Majaky, Figure 42. 39 %; Usatove, 35 %; Usatove-type burial, 35 %).

Thus, the long use of basic semantic markers in sign systems with fairly stable semantic fields indicates the existence of traditions in their transmission. Consequently, we received a positive answer to the question posed at the beginning of the section - the population of Trypillia-Cucuteni settlements perceived these (and other) images as signs of objects and phenomena that were part of the world of values in the ideology of the time.

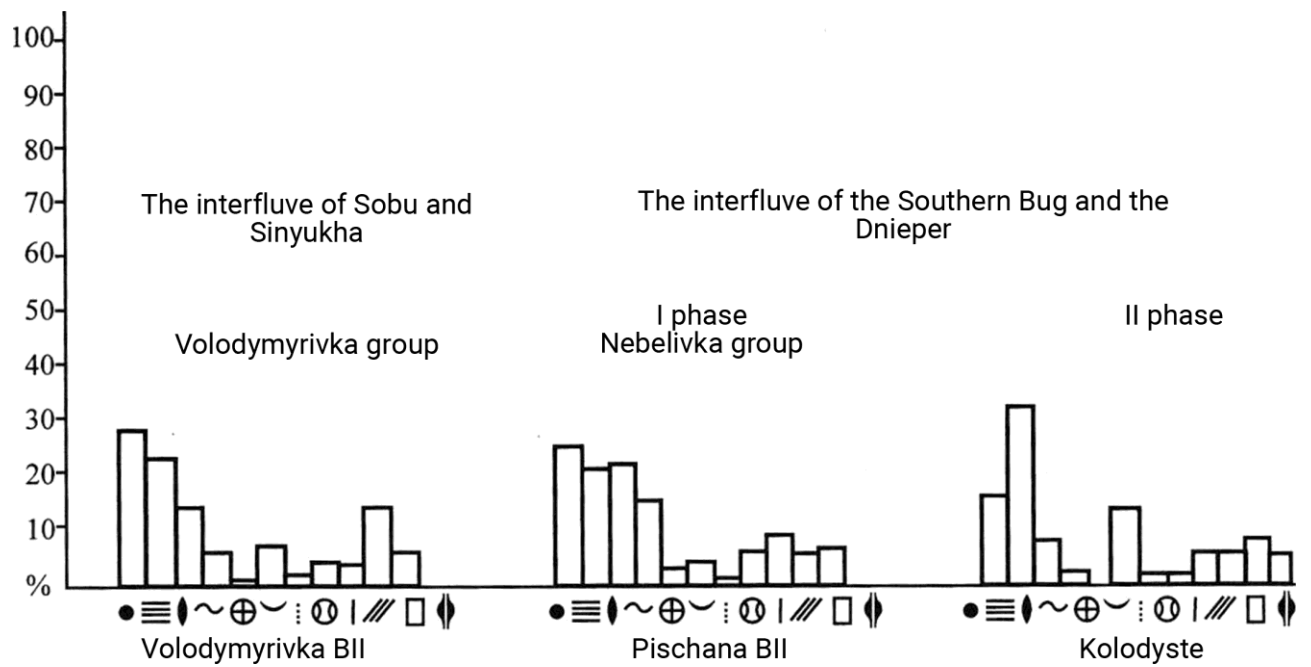

Figure 31: Dynamics of the use of basic signs (basic semantic markers) by the Trypillia-Cucuteni population between the Sob and Sinyukha rivers and the Southern Bug and Dnieper rivers

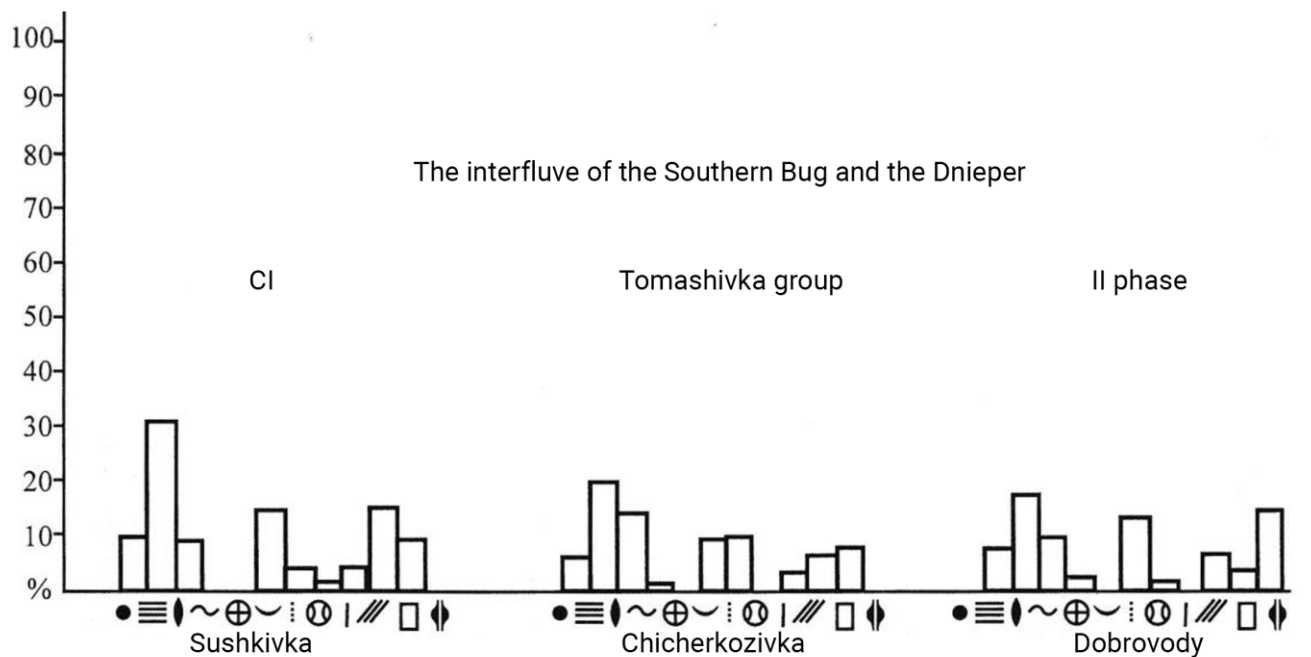

Figure 32: Dynamics of the use of basic signs (basic semantic markers) by the Trypillia-Cucuteni population of the interfluvium of the Southern Bug and the Dnieper

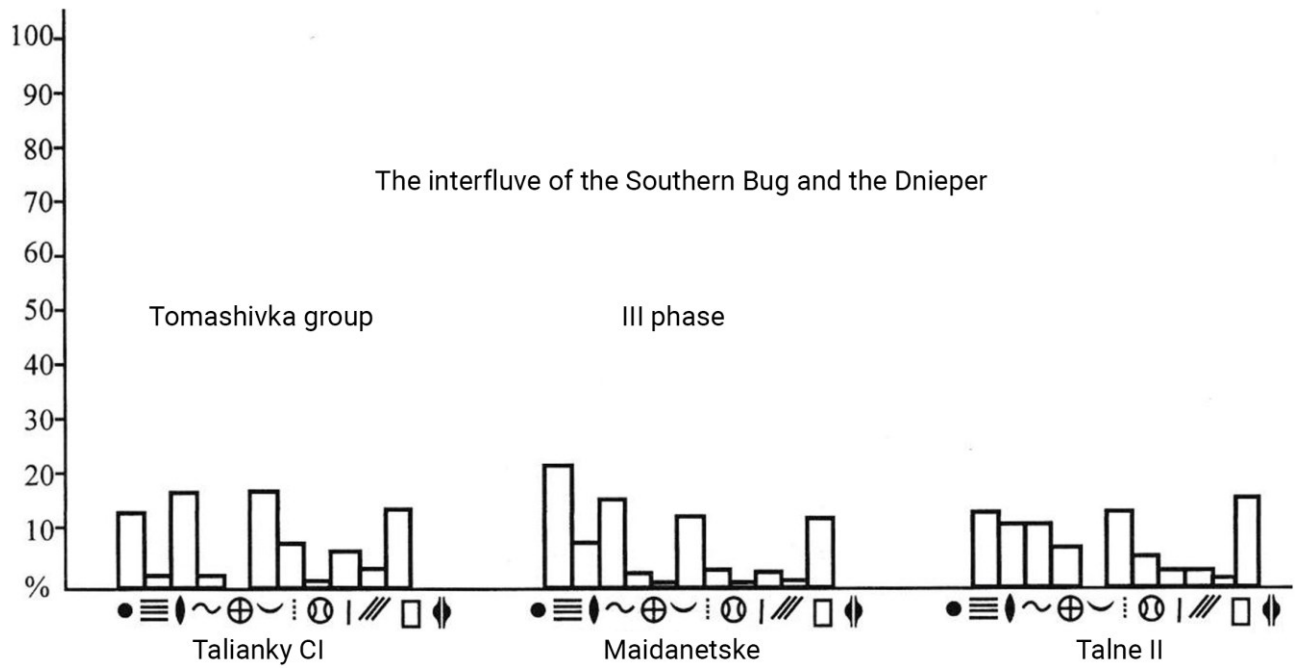

Figure 33: Dynamics of the use of basic signs (basic semantic markers) by the Trypillia-Cucuteni population of the interfluvium of the Southern Bug and the Dnieper

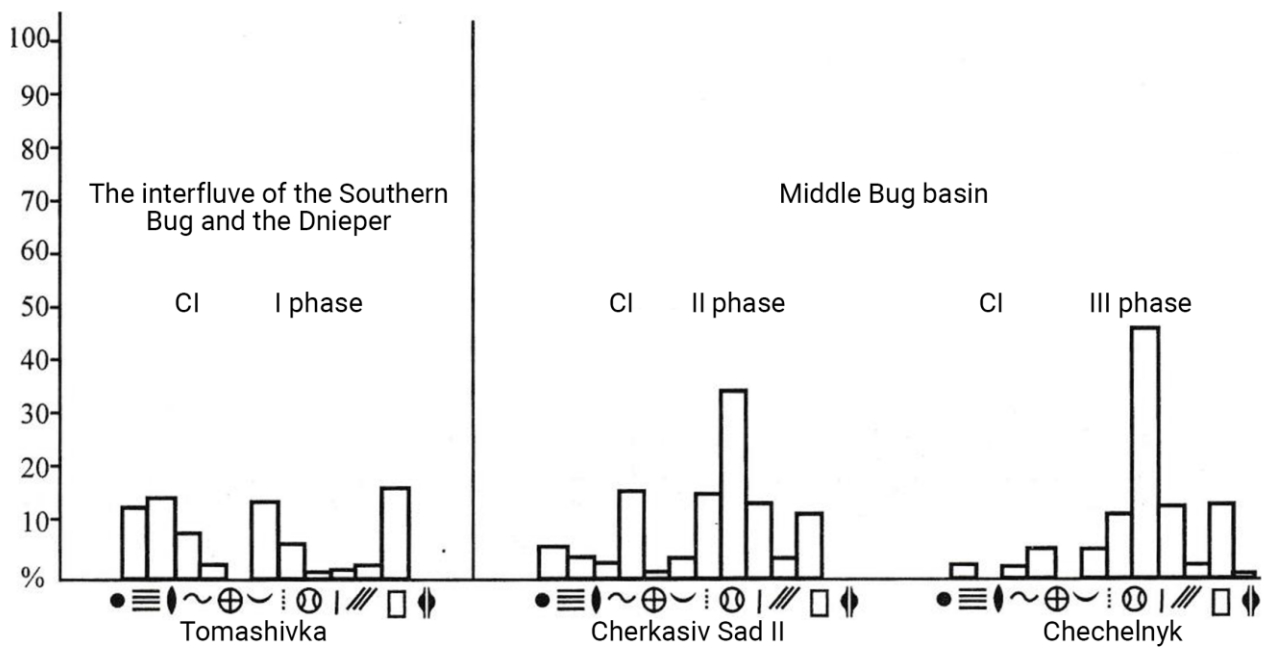

Figure 34: Dynamics of the use of basic signs (basic semantic markers) by the Trypillia-Cucuteni population of the Southern Bug and the Dnieper interfluvium and the middle Bug basin

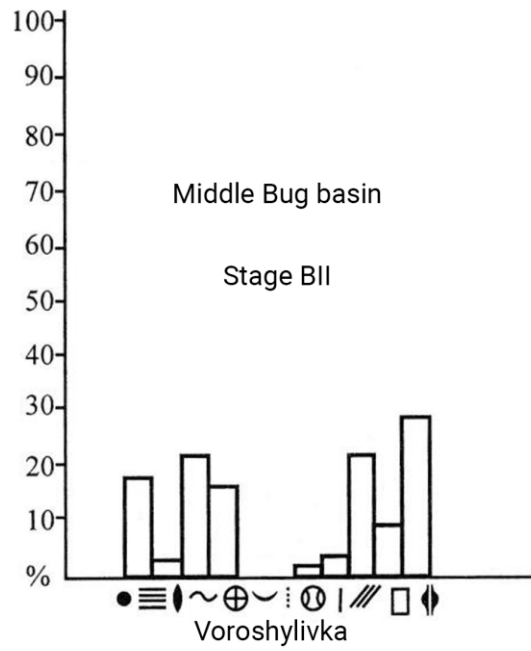

Figure 35: Dynamics of the use of basic signs (basic semantic markers) by the Trypillia-Cucuteni population of the middle Bug basin

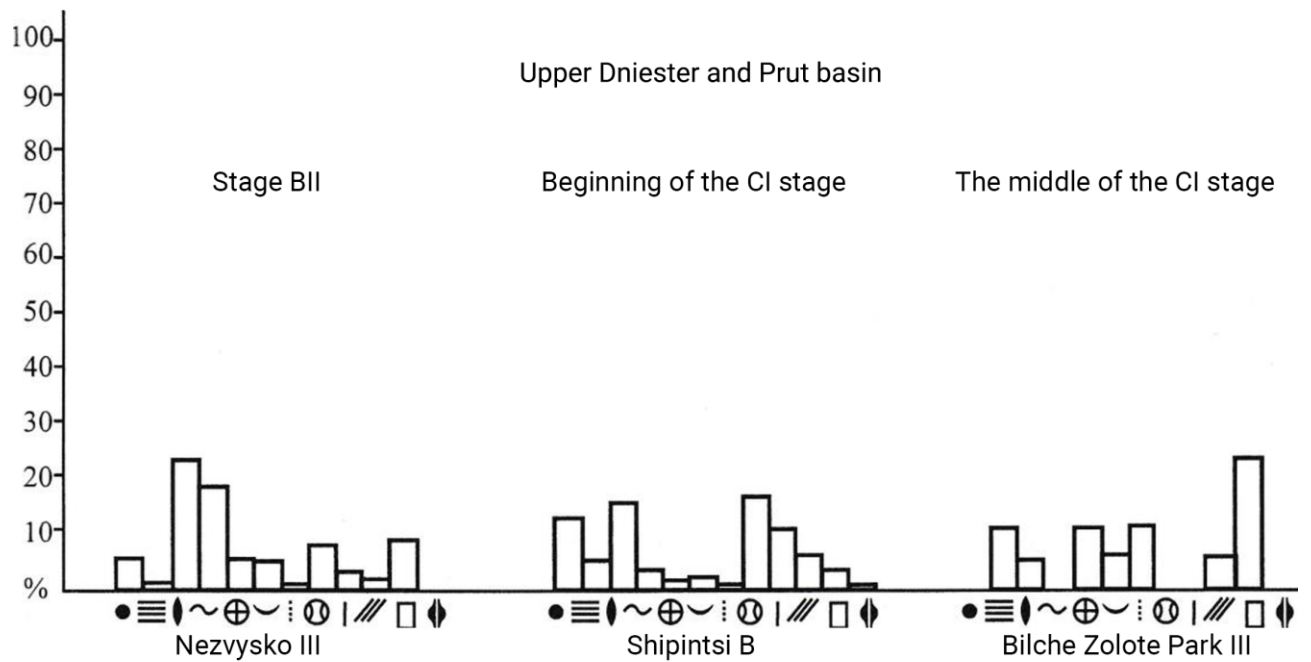

Figure 36: Dynamics of the use of basic signs (basic semantic markers) by the Trypillia-Cucuteni population of Upper Dniester and Prut basin

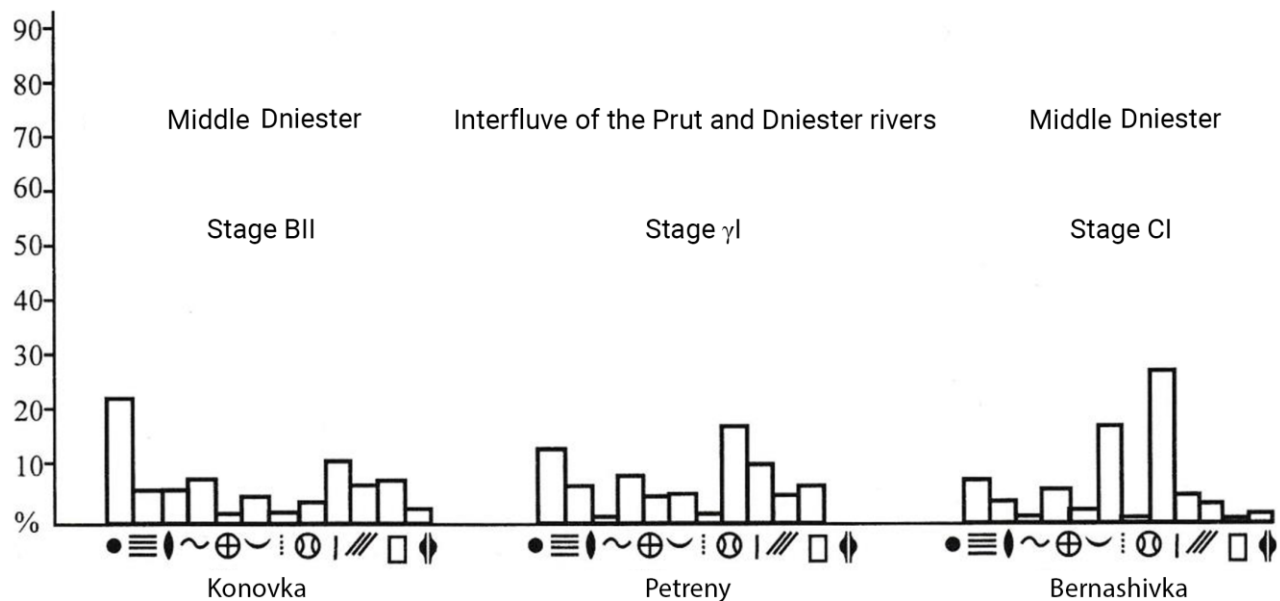

Figure 37: Dynamics of the use of basic signs (basic semantic markers) by the Trypillia-Cucuteni population of the Middle Dniester and the interfluvium of the Prut and Dniester rivers

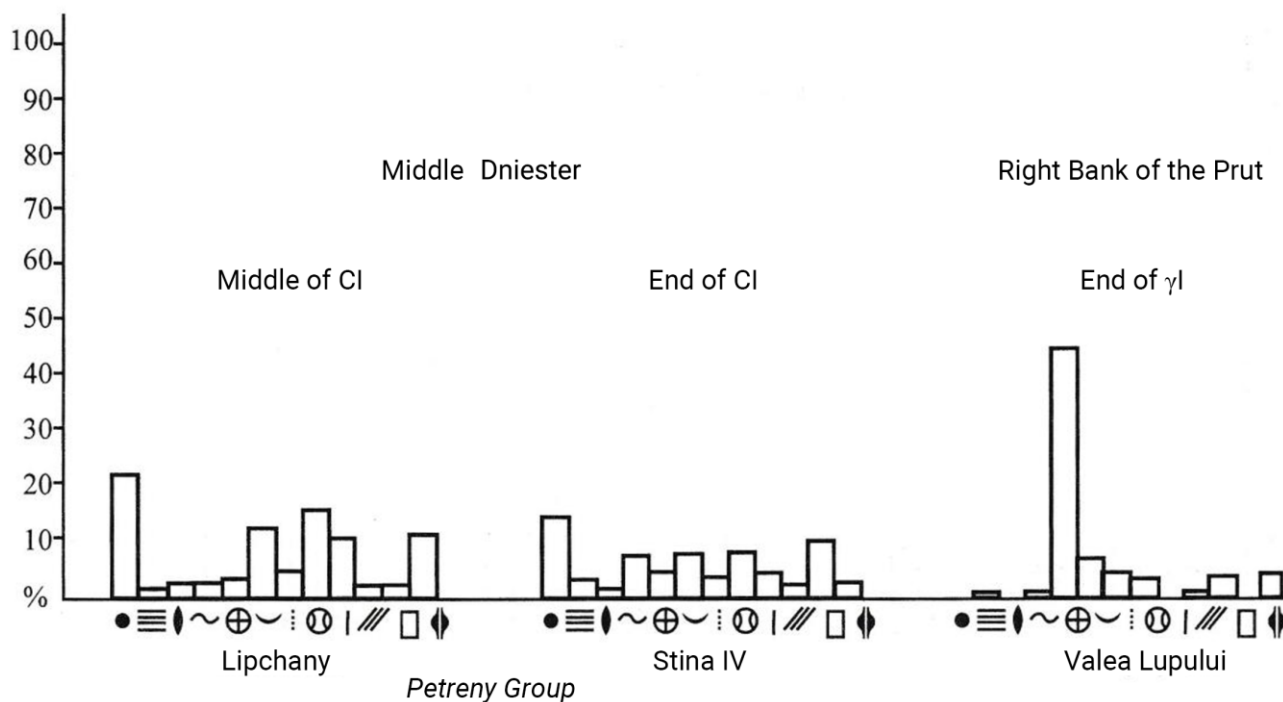

Figure 38: Dynamics of the use of basic signs (basic semantic markers) by the Trypillia-Cucuteni population of the Middle Dniester and the Right Bank of the Prut

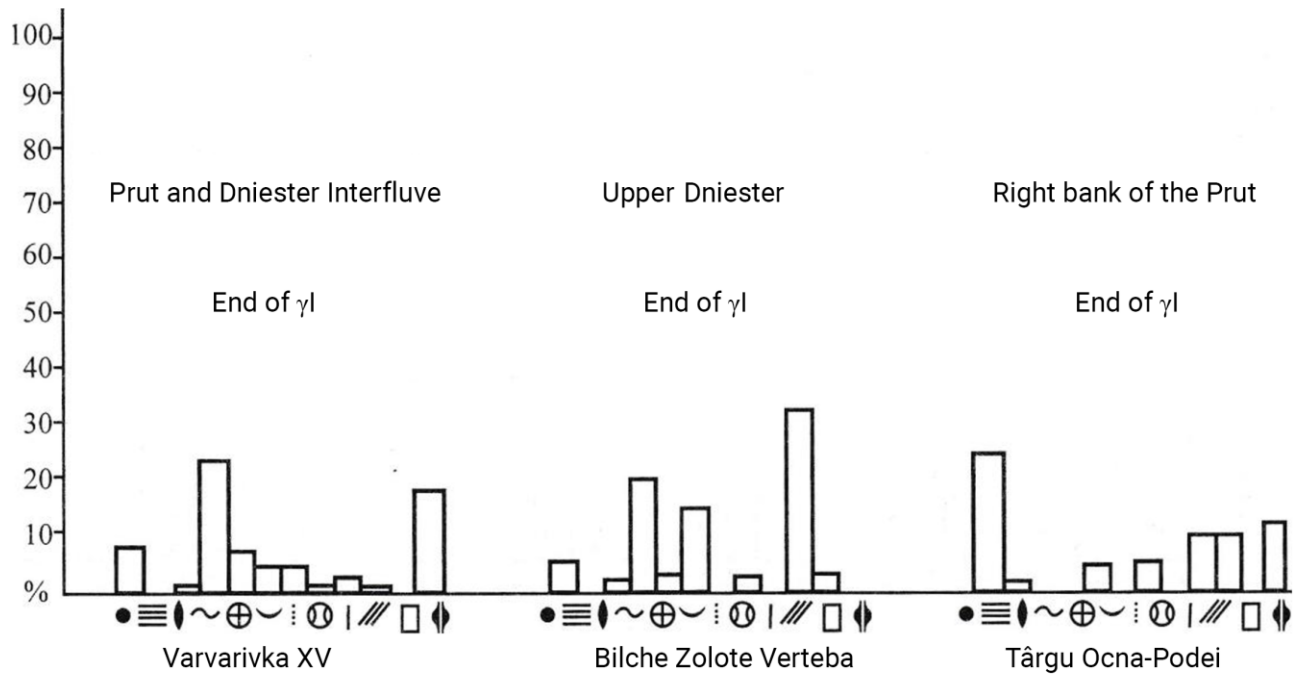

Figure 39: Dynamics of the use of basic signs (basic semantic markers) by the Trypillia-Cucuteni population of the Prut and Dniester interfluve, Upper Dniester, and the Right Bank of the Prut

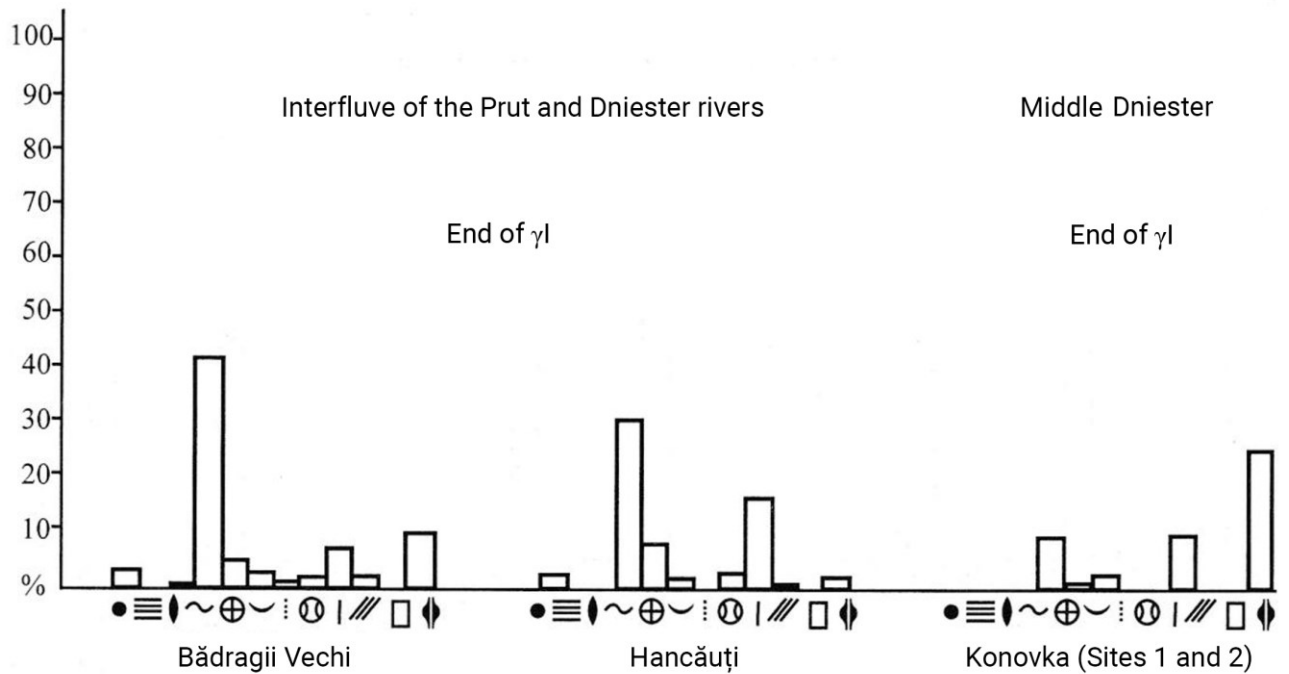

Figure 40: Dynamics of the use of basic signs (basic semantic markers) by the Trypillia-Cucuteni population between the Prut and Dniester rivers and the Middle Dniester

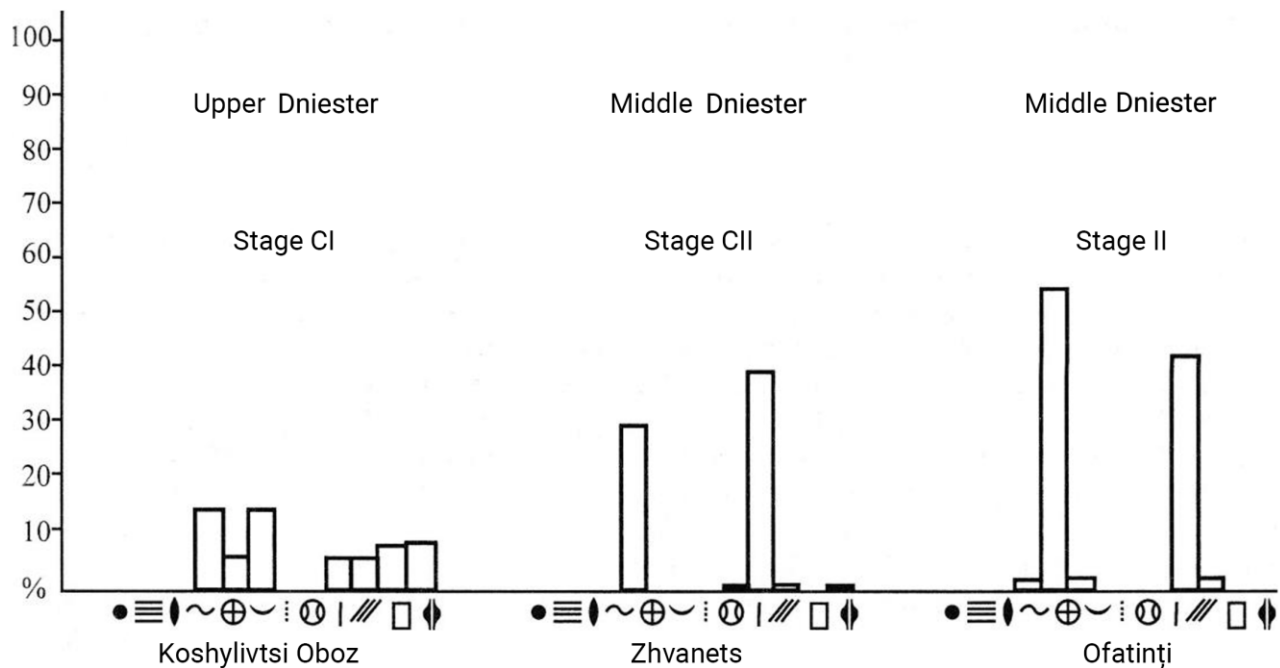

Figure 41: Dynamics of the use of basic signs (basic semantic markers) by the Trypillia-Cucuteni population of the Upper and Middle Dniester

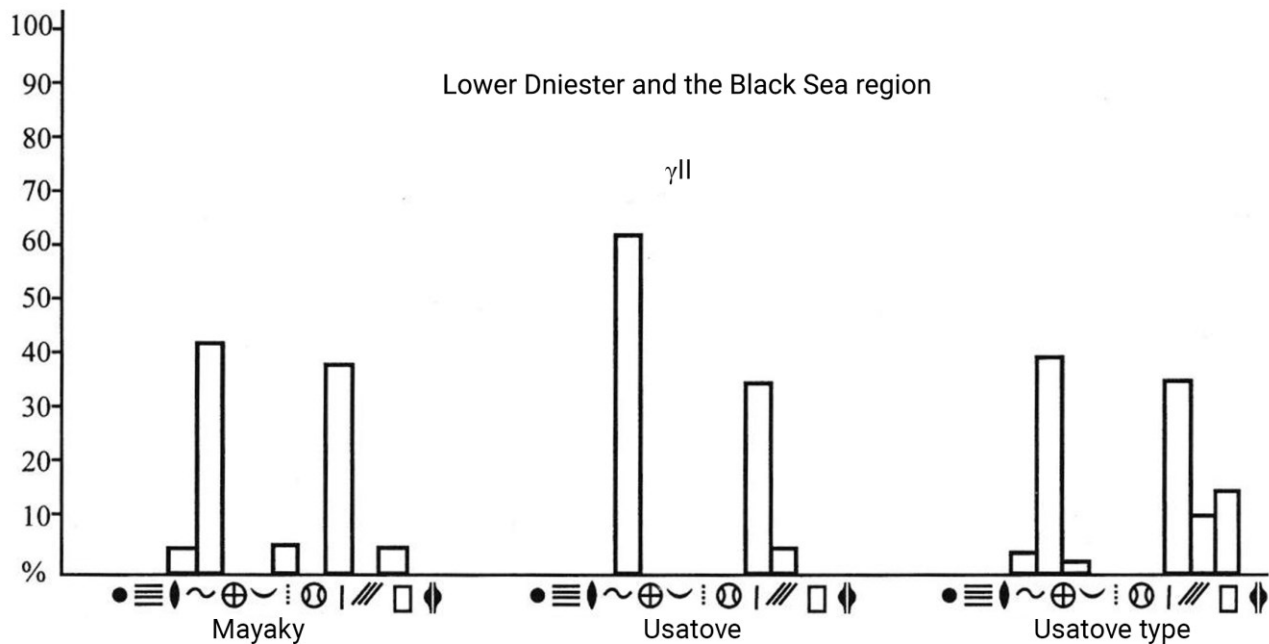

Figure 42: Dynamics of the use of basic signs (basic semantic markers) by the Trypillia-Cucuteni population of the Lower Dniester and the Black Sea region

Dynamics of use of the basic figures of a list of wares

The upper projection on the vessel allows us to notice that its paintings form three main figures, which unite small variable signs into systems. These are crosses (static compositions), swastikas (dynamic compositions), and a combination of crosses and swastikas (static-dynamic compositions). Since these figures are also signs hierarchically higher than small variable graphs, it is important to consider the dynamics of their use. Indicators of their use are included in histograms, where the first column indicates the number of static circuits, second - the number of dynamic, and the third - static-dynamic compositions. All indicators are given in percent. In the Upper Dniester region, from where the population migrated to the Middle Bug basin, at the stage of BI most static compositions were used (47 %), less - dynamic (32 %), even less - static-dynamic (see: Histogram 1. Nezvysko III, №1).

At this time in the use, in the Middle Bug basin, in the settlement of Voroshylivka the same ratio of compositions of the scheme of painting is observed: static – 51 %, dynamic – 48 %, static-dynamic – 1 % (histogram 3, № 22). But in the more eastern settlement of Volodymyrivka, which is located almost on the border of the then Trypillia-Cucuteni oikumene, the ratio of the main figures of the painting of utensils is different. Most often, dynamic compositions were used here (48.5 %), somewhat less - static (45 %), and very few - static-dynamic figures (6.5 %) (histogram 3, № 25). A similar ratio is maintained in the later settlement of the first phase of the Nebelivka group on static compositions 38%, dynamic-5 3%, static-dynamic-8% (histogram 3, № 26). It is also observed in the paintings of the settlements of the Shipintsi group in the Upper Dniester, starting from the end of the BI stage and the beginning and middle of the CI stage (Shipintsi B: static compositions 35 %, dynamic – 38 %, static-dynamic – 27 %, Bilche Zolote Park III: static compositions 29 %, dynamic - 46.5 %, static-dynamic - 24.5 % (histogram 1, №2, №3) It is noticeable on the northern monuments of the Petreny group: static compositions 39 %, dynamic – 51 %, static-dynamic – 10 % (Bernashivka, histogram 1, №7).

In the more southern settlement Petreny, between the Prut and Dniester rivers, static compositions dominate (57 %), dynamic ones are used less (37 %), and static-dynamic ones are used even less (6 %) (histogram 2, №12). A little earlier, at the end of the BI stage, we have the following ratio of the main figures of the painting in the phase II settlement of the Nebelivka group - Kolodyste: static compositions make up 53 %, dynamic – 25 %, static-dynamic – 22 % (histogram 3, №27). It is stored here and on dishes from the settlements of phase II of the Tomashivka group Sushkivka: static compositions 48 %, dynamic – 39 %, static-dynamic – 13 %, and Chicherkozivka: static compositions 49 %, dynamic - 28 %, static-dynamic – 23 % (histogram 3, № 28, №29). But in the settlement of Dobrovody at the same time, they are broken. The use of static compositions decreases (26 %), static-dynamic compositions (35 %) is those, slightly dominated by dynamic (39 %) (histogram 3, № 30). A similar dominant persists in the later phase III settlement of the Tomashivka group of Talianky, although static compositions were used here more often (31 %) than dynamic ones (27 %) (histogram 3, №31). In Maidanetske the number of three main figures of ornamentation is almost the same: static compositions 33 %, dynamic – 35 %, static-dynamic – 32 % (histogram 3, №32).

In the ornamentation of Talne II and Tomashivka static paintings again dominate (41 %; 42 %). In Talne II the second place in terms of use is occupied by static-dynamic compositions (33 %), dynamic – 26 % (histogram 3, № 33), and in Tomashivka - the third (27 %), dynamic 31% (histogram 3, № 34). In general, in Tomashivka (phase IV) we have a kind of return to the ratios of the main figures of the painting of phase II of the group (Sushkivka, Chicherkozivka).

In the middle of the Bug basin, at the beginning of CI on the dishes of the settlement of Cherkasiv Sad II the ratio of ornamental compositions is similar to Volodymyrivka (stage BI), Shipintsi, and Northern-Petreny (stage CI): static compositions 40 %, dynamic – 53 %, static-dynamic – 7 %. But in the later settlement of Chechelnyk, the ratio of the main figures becomes the same as in the second phase of the Tomashivka group: 42 % of static compositions, 36 % of dynamic ones, 19 % of static-dynamic ones (histogram 3, № 24): static compositions 47 %, dynamic – 40 %, static-dynamic – 13 % (histogram 1, № 8). Dominant in Stina IV (histogram 1, №9) are static compositions (43 %), slightly less used dynamic (42 %), and even less - static-dynamic (15 %). Within the CI-γI stage on the Right Bank of the Prut, in the settlement of Valea Lupului II, changes in the ratios of the main ornamental figures begin to occur. This is similar to the changes among the main figures of Dobrovody tableware before the beginning of strong changes in the ornamental compositions of the Tomashivka group. In Valea Lupului II static-dynamic compositions are dominant (44 %), fewer dynamic figures were used (34 %), and even less static (22 %) (histogram 2, № 16). In the Upper Dniester at the end of the CI stage in Bilche Zolote Vertebe I dynamic compositions dominated (49 %), static-dynamic ones were used less often (32 %), and static paintings were used even less often (19 %) (histogram 1, №4).

In the settlements between the rivers Prut and Dniester, starting from Varvarivka XV and during the existence of monuments of the Bădragii type, the use of dynamic schemes of painting decreases, and in the settlement of Konovka (site 1, 2) they do not exist. In Varvarivka XV static compositions dominate – 58 %, dynamic 8 %, static-dynamic – 34 % (histogram 2, №13). In the later settlement of Bădragii Vechi static-dynamic compositions (55 %), static compositions (37 %), dynamic – (8%) were most often used (histogram 2, 1, №14); In Hancăuți I the compositions include static (64 %), dynamic – (4 %), static-dynamic – (32 %) (histogram 2, №15). In Konovka, (site 1, 2) the number of static and static-dynamic compositions is the same (49 %) (see histogram 1, №10). On the vessel of the settlement of the end of CI in the Upper Dniester Koshylivtsi static compositions comprise roughly 56 %, dynamic – 6 %, static-dynamic – 38 % (histogram 1, №5). CI in the settlements of the Upper and Middle Dniester: static compositions 35 %, dynamic-48 %, static-dynamic – 17 % (histogram 2, №17), Perhaps this is due to the conservation of traditions on the periphery of culture. The Dniester, the paintings of the Zhvanets settlement are dominated by static compositions (74 %), dynamic ones are absent, and static-dynamic, in comparison with Bădragii, are used less (26 %) (histogram 1, № 11). Stage γII, the middle Dniester basin, and the Black Sea region are also dominated by static compositions, their number is very significant, the use of static-dynamic compositions is small, and dynamic paintings are absent (Ofatinți: static compositions 86 %, static-dynamic – 14 % (histogram 2, № 18); burials of Usatove type: static compositions 92 %, static-dynamic – 8 % (histogram 12, № 21), or are used rarely (Usatove: static compositions 60 %, dynamic – 18 %, static-dynamic – 22 % (histogram 2, № 19). There are no static-dynamic compositions in the Majaky, and dynamic ones take second place (10 %) after static ones (90 %) (histogram 2, № 20).

Thus, at the end of the CI-γI stage and the CII-γII stage, some important changes took place in the sign systems of the Trypillia-Cucuteni cultural and historical community.

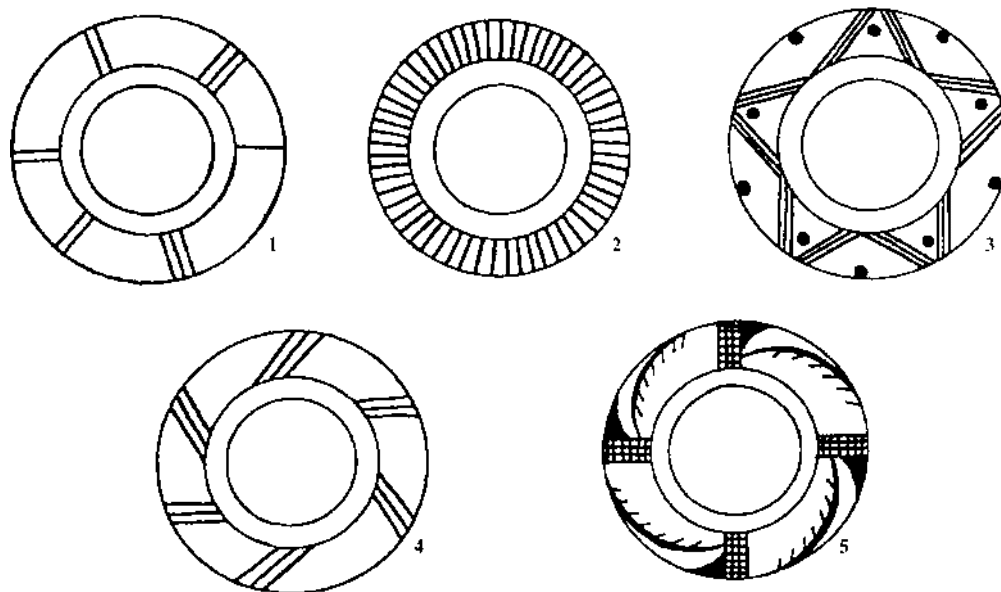
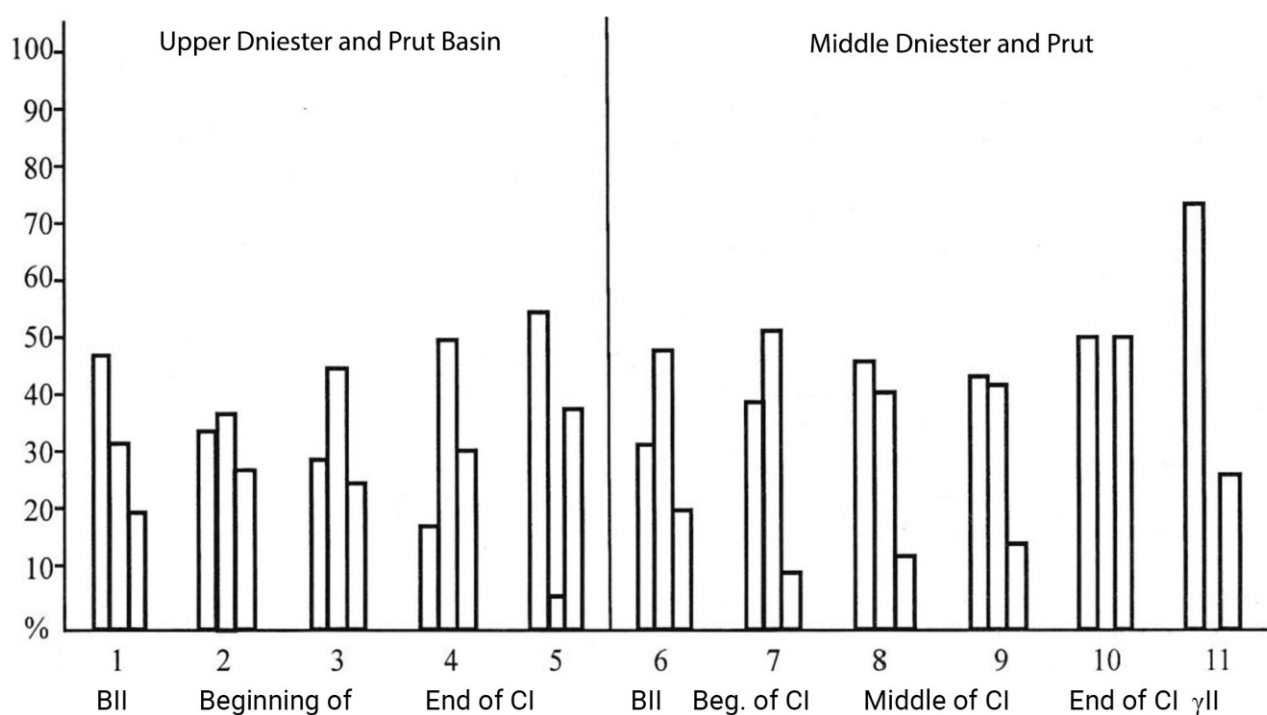
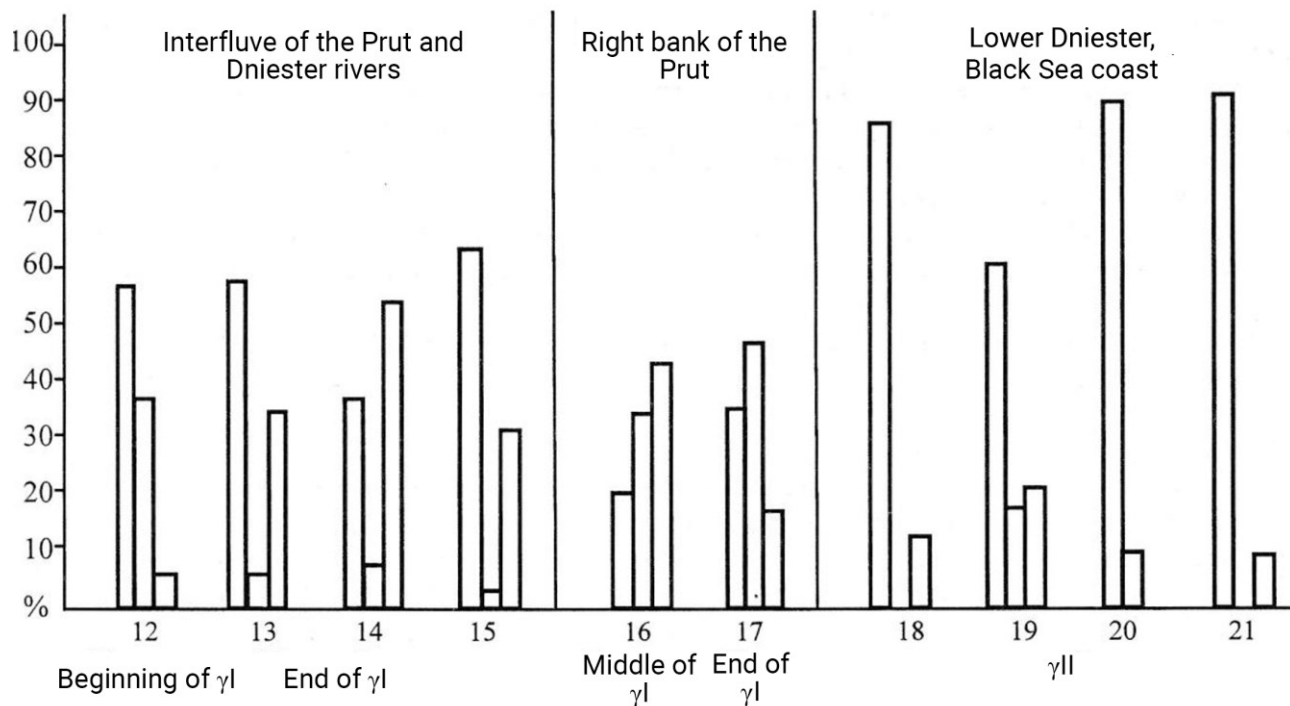

Figure 43: Schemes of painting cups of Tomashivka settlements: 1-3 - static compositions; 4 - dynamic composition; 5 - combining static and dynamic compositions.



Histogram 1: The use of painting schemes



Histogram 2: Use of painting schemes

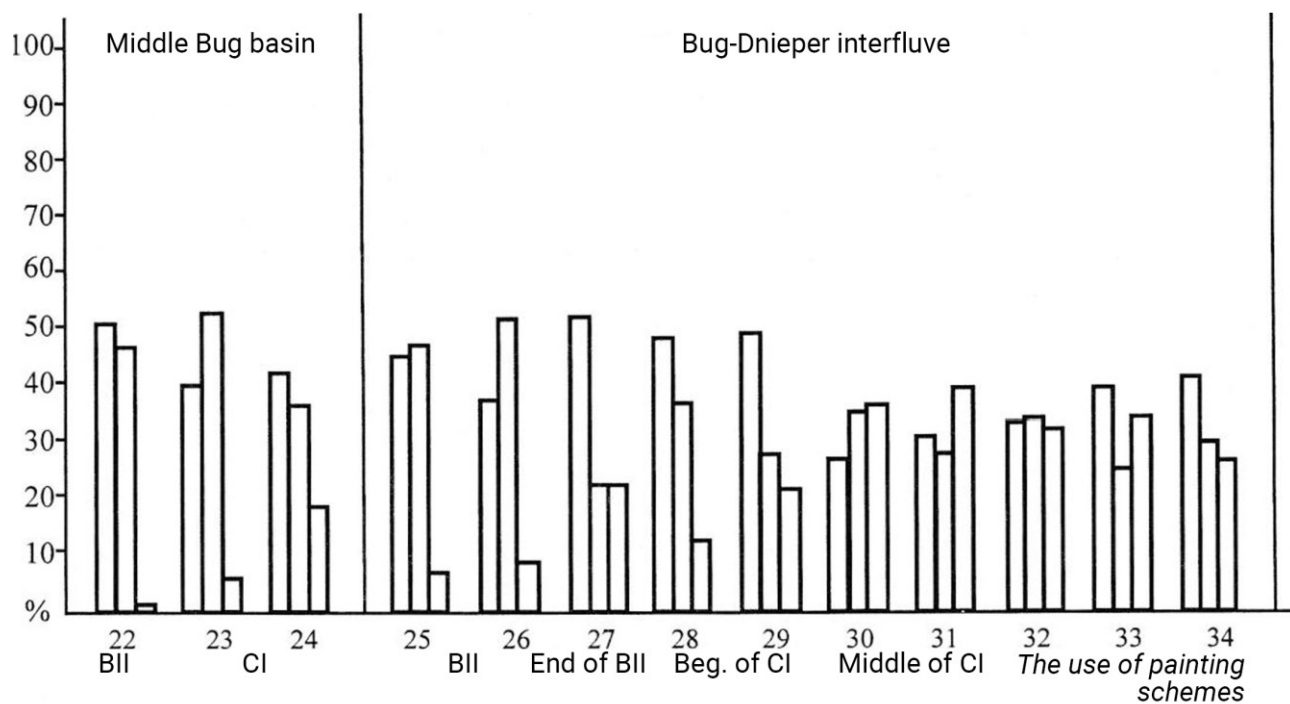

Histogram 3: Use of painting schemes

Histograms of the use of general schemes of painting (key):

1. Nezvysko III. 2. Shipintsi B. 3. Bilche Zolote Park III. 4. Bilche Zolote Vertebe I. 5. Koshylivtsi Oboz.
6. Konovka. 7. Bernashivka. 8. Lipchany. 9. Stina IV. 10. Konovka (site 1, 2). 11. Zhvanets. 12. Petreny.
13. Varvarivka XV. 14. Bădragii Vechi. 15. Hancăuți I. 16. Valea Lupului II. 17. Târgu Ocna-Podei. 18. Ofatinți. 19. Usatove. 20. Majaky. 21. Burials of the Usatove type.

The development of the use of basic schemes went in the direction of reduction and, finally, the disappearance of dynamic paintings, a decrease in static-dynamic, and the eventual increase in the dominance of static figures. Further, there is a change in the means of organizing small characters into the "text" system. The same changes took place at the level of the use of small variable signs. The very insignificant use of several important semantic markers at the stage of CII-γII at the stage of BI, CI-γI indicates important changes in the ideology of the population of this time. The lunar symbolism dominating in the previous stages (BI, CI-γI) disappears from the sign systems, it is replaced by the symbolism of water closest to it in semantic fields with an important additional semantic load - the definition of a snake. Thus, it can be assumed that at the stage of CII-γII there is a replacement of lunar cults with aquatic ones.

Search for subjects of semiosis

Materials from large-scale excavations of large settlements of the Tomashivka local chronological group of Maidanetske and Talianki play an important role in identifying the rules of functioning of the Trypillia-Cucuteni sign system. Here, thanks to more than twenty years of complex expeditions under the leadership of Shmagli (Maidanetske) and Kruts (Talianki), whole sections of ring structures of settlements were excavated, consisting of the remains of buildings. A particularly long section, consisting of 21 buildings, was excavated in the settlement of Maidanetske (Videiko M. Y. 1990., p. 117-120). This made it possible to trace the use of small signs on the paintings of the dishes, to investigate their distribution in each dwelling, and to check the possible connections (at the sign level) between the houses. Unfortunately, it is not possible to use all the material in the analysis, because the paintings are not well-preserved everywhere. Based on this, we can discuss the trends in the use and relationships between houses.

Indicators of static-positional analysis, given in the table "Comparative analysis", showed that the largest number of identical signs (more than 10) occurred on the dishes of complexes "П" and "Я". Together we found 18 characters here. Slightly fewer common signs were found in complexes "П" and dwelling 1, as well as complexes "Ш" and "Я". 12 common signs occurred in the complexes "П" and "Ю"; "П" and dwelling 2; "О" and "Я"; "Ц" and "Я"; "Я" and dwelling 1. Complexes "О" and "П" have 11 common graphemes; "Ц" and dwelling 1. The above analysis allows us to see that the largest connections in the excavated area are observed between a very large "dwelling" of the complex " П " (300 m²) (Videyko M. Y., 1990., p. 119) and the opposite part of the study area, complexes "Я", "Ш", "Ц", "Ю", dwellings 1 and 2. This almost completely coincides with the "nodes" of the ring structures "А" and "Б" selected by M. Y. Videyko (ibid., P. 117). The complex "Я", in turn, is connected with the complexes "Ш", "Ц", dwelling 1 and the remote complex "О". Very strange is the lack of connection between the complexes "Ф", "Х", "Ц", "Ч" (less than 10 characters) with any "sites". No less interesting is the slight similarity of the signs between neighboring houses. Exceptions are the connections between the complexes "П" and "О", as well as "Я" and dwelling.

Finally, we note that these common signs belong to simple, widespread graphemes, most of which are also semantic markers, i.e. belong to very archaic signs that have been passed down from generation to generation. Graphic expressions in the form of associations of signs into blocks are peculiar only to each separate house, both within this dwelling and on other dwellings. The same is observed at the dwellings of Talianki (see figures below). Moreover, this phenomenon probably also applies to settlements of other local chronological groups, where, unfortunately, such extensive excavations were not carried out making it impossible to conduct such an analysis at the level of large excavated areas of settlements. Consequently, it becomes obvious that the common for all houses were not complex signs-blocks, but the forms of utensils, often used schemes of its painting and, sometimes, simple signs. As for the sign-blocks, the rules of their installation were common to all buildings. The signs-blocks themselves, their graphic expressions in most cases are unique. Probably, in each house, there were people (or one person) who, knowing simple signs and following the rules of their installation, could create their new combinations. Thus, during the existence of certain local chronological groups (in our case Tomashivka) with a certain transformation, the forms of utensils, general schemes of painting as well as rules for

assembling signs and sets of simple graphemes, which in most cases belonged to semantic markers, were preserved.

Table 2: Signs of the settlement of Maidanetske

Dw. «Є»	c. «Ж» Dw.1	c. «Ж» Dw1	c. «Ж» Dw.2	c. «Ж» Dw.3	c. «Ж» Dw.4	comp. «І»	comp. «М»	comp. «О»	comp. «Ф»	comp. «Х»	comp. «Ц»	comp. «Ч»
7	2	10	4	5	2	3	9	4				
5	2	5		2								
2	2											
4	2	4	3			4	4		2	3		
2	2											
		3										
3		4	8				2			2		
							3					
2				4	4		2		2			

Table 3













































comp. «Ш»	comp. «Щ»	comp. «Е»	comp. «Ю»	comp. «Я»	Dw. 1	Dw. 2	Dw. 3						
													
													
													
													
													
													
													
													
													

Table 4

Dw. «Є»	c. «Ж» Dw.1	c. «Ж» Dw.1	c. «Ж» Dw.2	c. «Ж» Dw.3	c. «Ж» Dw.4	comp. «І»	comp. «М»	comp. «О»	comp. «Ф»	comp. «Х»	comp. «Ц»	comp. «Ч»

Table 5

comp. «Ш»	comp. «Щ»	comp. «Е»	comp. «Ю»	comp. «Я»	Dw. 1	Dw. 2	Dw. 3					

Table 6

Dw. «Є»	c. «Ж» Dw.1	c. «Ж» Dw.1	c. «Ж» Dw.2	c. «Ж» Dw.3	c. «Ж» Dw.4	comp. «І»	comp. «М»	comp. «О»	comp. «Ф»	comp. «Х»	comp. «Ц»	comp. «Ч»

Table 7





















comp. «Ш»	comp. «Щ»	comp. «Е»	comp. «Ю»	comp. «Я»	Dw. 1	Dw. 2	Dw. 3					
												
												
												
												
												
												

Table 8

c. «Ж» Dw. 2	c. «Ж» Dw. 3	c. «Ж» Dw. 4	comp. «І»	comp. «М»	comp. «О»	comp. «П»	comp. «Ф»	comp. «Х»	comp. «Ц»	comp. «Ч»	comp. «Ш»	comp. «Щ»

Table 9





comp. «E»	comp. «O»	comp. «Я»	Dw. 1	Dw. 2	Dw. 3								
													
													
													
													

Table 10

c. «Ж» Dw. 3	c. «Ж» Dw. 4	comp. «І»	comp. «М»	comp. «О»	comp. «П»	comp. «Ф»	comp. «Х»	comp. «Ц»	comp. «Ч»	comp. «Ш»	comp. «Щ»	comp. «Е»

Table 11





comp. «O»	comp. «Я»	Dw. 1	Dw. 2	Dw. 3								
												
												
												

Table 12

c. «Ж» Dw. 3	c. «Ж» Dw.4	comp. «І»	comp. «М»	comp. «О»	comp. «П»	comp. «Ф»	comp. «Х»	comp. «Ц»	comp. «Ч»	comp. «Ш»	comp. «Щ»	comp. «Ъ»

Table 13







comp. «O»	comp. «Я»	Dw. 1	Dw 2	Dw. 3								
												
												
												
												

Table 14

























c. «Ж» Dw. 3	c. «Ж» Dw. 4	comp. «І»	comp. «М»	comp. «О»	comp. «П»	comp. «Ф»	comp. «Х»	comp. «Ц»	comp. «Ч»	comp. «Ш»	comp. «Щ»	comp. «Е»
												
												
												
	 2											
												
												
												
												
												
												
												
												
												
												
	 2											
	 7											
												
												

Table 16



















c. «Ж» Dw. 4	comp. «І»	comp. «М»	comp. «О»	comp. «П»	comp. «Ф»	comp. «Х»	comp. «Ц»	comp. «Ч»	comp. «Ш»	comp. «Щ»	comp. «Е»	comp. «Ю»
												
												
												
												
												
												
												
												
												
												
												
												
												
												
												
												
												
												

Table 17

























comp. «І»	comp. «М»	comp. «О»	comp. «П»	comp. «Ф»	comp. «Х»	comp. «Ц»	comp. «Ч»	comp. «Ш»	comp. «Щ»	comp. «Е»	comp. «Ю»	comp. «Я»
												
												
												
												
												
												
												
												
												
												
												
												
												
												
												
												
												
												

Table 19























comp. «М»	comp. «О»	comp. «П»	comp. «Ф»	comp. «Х»	comp. «Ц»	comp. «Ч»	comp. «Ш»	comp. «Щ»	comp. «Е»	comp. «Ю»	comp. «Я»	Dw. 1
												
												
												
												
												
												
												
		 3									 2	
												
												
												
												
												
												
												
												
												
												

Table 20

























comp. «П»	comp. «Ф»	comp. «Х»	comp. «Ц»	comp. «Ч»	comp. «Ш»	comp. «щ»	comp. «Е»	comp. «Ю»	comp. «Я»	Dw. 1	Dw. 2	Dw. 3
												
												
												
												
												
												
												
												
												
												
												
												
												
												
												
												
												
												

Table 21

comp. «П»	comp. «Ф»	comp. «Х»	comp. «Ц»	comp. «Ч»	comp. «Пл»	comp. «Щ»	comp. «Е»	comp. «Ю»	comp. «Я»	Dw. 1	Dw. 2	Dw. 3

Table 22





















comp. «Ц»	comp. «Ч»	comp. «Ш»	comp. «Щ»	comp. «Е»	comp. «Ю»	comp. «Я»	Dw. 1	Dw. 2	Dw. 3			
												
												
												
												
												
												
												
												
												
												
												
												
												
												
												
												
												
												

Table 23





















comp. «Ц»	comp. «Е»	comp. «Ю»	comp. «Я»	Dw. 1	Dw,2	Dw. 3								
														
														
														
														
														
														
														
														
														
														
														
														
														
														
														
														
														
														

Table 24





































comp. «Я»	Dw. 1	Dw. 2	Dw. 3										
													
													
													
													
													
													
													
													
													
													
													
													
													
													
													
	 2												
													
													

Table 25

Dw. 1	Dw. 2	Dw. 3										
												
												
												
												
												
												
												
												
												
												
												
												
												
												
												
												
												
												

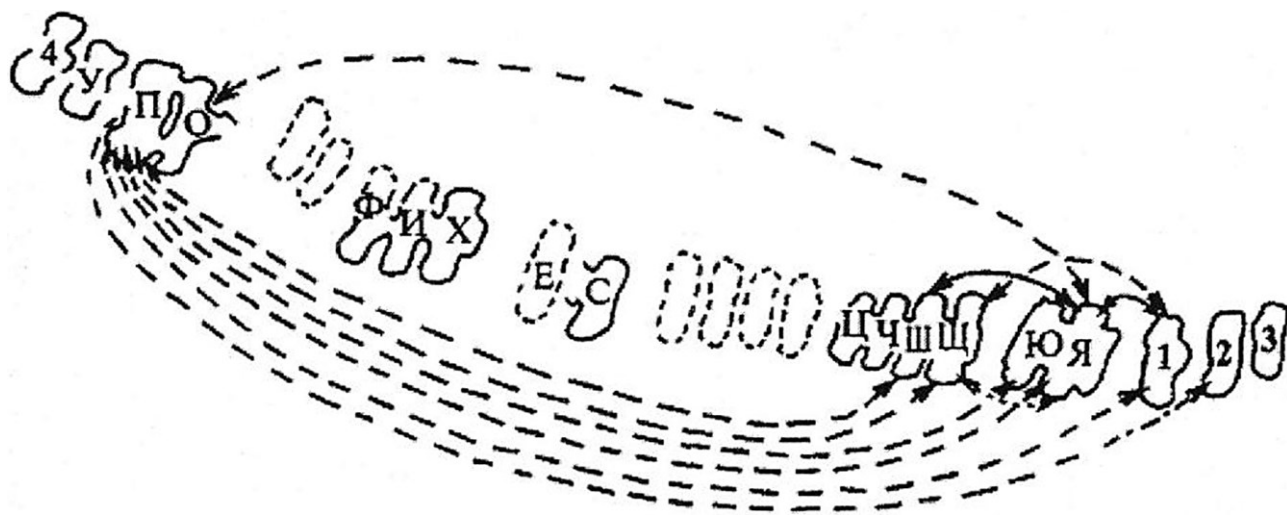

Figure 44: Connections between dwellings at the sign level (more than 10 signs)

signs	19	63	18	9	14	7	24	28	7	18	45	31	30	15
Dw.	О	П	Ф	Х	Ц	Ч	Ш	Щ	Е	Ю	Я	1	2	3
О	11	5	3	4	1	7	8	3	8	12	9	5	-	
П		6	2	8	2	15	11	4	12	18	13	12	8	
Ф			1	3	-	6	6	3	4	7	5	6	3	
Х				2	1	2	4	-	2	4	5	1	3	
Ц					-	6	4	3	3	6	6	3	3	
Ч						3	1	1	1	2	1	1	1	
Ш							8	4	7	13	6	9	6	
Щ								2	7	12	11	7	9	
Е									4	4	3	2	1	
Ю										10	6	5	5	
Я											12	10	8	
1												8	9	
2													6	
3														

Table 27: Taliunki settlement signs.













































Dw. 1	2	3	4	5	6	7	8	9	10	11
 2							 4			 3
 3										
										
										
										
										
										 2
	 2									
	 5	 2		 2		 4	 4	 6		 3
										
										
										
										
	 2					 2				 2
										
										

Table 28





















Dw. 12	13	14	15	16	17	18	19	20	21	
	● ⁶				●	● ²	● ³	● ²		
										
										
										
										
										
										
										
										
										

Table 29

Dw. 2	3	4	5	6	7	8	9	10	11	12

Table 30



























Dw. 13	14	15	16	17	18	19	20	21	22	
										
										
										
										
						 ²				
 ²				 ²	 ²	 ²				
			 ²					 ²		

Table 31





































Dw. 2	3	4	5	6	7	8	9	10	11	12
 ²						 ²	 ³			
										
				 ²	 ³		 ⁵	 ²		
										
										
										
										
	 ²									
										
				 ²						
										
										
										
										
			 ²		 ²		 ²	 ³		

Table 32



























Dw. 13	14	15	16	17	18	19	20	21	22	
										
										
										
										
										
										
										

Table 33



























Dw. 4	5	6	7	8	9	10	11	12	13	
										
										
										
										
										
										
										
										
										
										
										
										
										
										
										

Table 34









Dw. 14	15	16	17	18	19	20	21	9	10	11
										
										
				 2		 3	 2			

Table 35























Dw. 5	6	7	8	9	10	u	12	13	14	
				 ³		 ³		 ²		
										
										
										
										
										
										
										
										
										
										
										
										
										
										

Table 36











Dw. 15	16	17	18	19	20	21	22			
			 5			 2				
		 3		 3						
										
										
										
										

Table 37

















Dw. 7	8	9	10	11	12	13	14	15	16	
										
										
										
							 ²			
 ²										
										
										
										
										
										
										
 ²										
										
										

Table 39

























Dw. 7	8	9	10	11	12	13	14	15	16	
										
										
										
										
										
										
										
										
										
										
										
	 ³					 ²				
										
	 ²	 ²					 ²			
										

Table 40







Dw. 17	18	19	20	21	22					
										
										
										

Table 41





















Dw. 8	9	10	11	12	13	14	15	16	17	
										
										
										
										
										
										
										
										
										
										
										
										
										
										
										

Table 43

















Dw. 9	10	11	12	13	14	15	16	17	18	
										
										
										
+										
										
										
										
										
										
										
										
										
										
										

Table 45



















Dw. 11	12	13	14	15	16	17	18	19	20	
										
										
										
										
										
										
										
										
										
										
										
										
										
										
										
										

Table 46

















Dw. 13	14	15	16	17	18	19	20	21	22	
										
										
										
										
										
										
										
										
										
										
										
										
										
										
										

Table 47

















Dw. 14	15	16	17	18	19	20	21	22		
										
										
										
										
										
										
										
										
										
										
										
										
										
										
										

Table 48

















Dw. 15	16	17	18	19	20	21	22			
										
										
										
										
										
										
										
										
										
										
										
										
										
										

Table 49





























Dw. 18	19	20	21	22						
										
										
										
										
										
										
										
										
										
										
										
										
										
										

Table 50

Dw. 20	21	22								
										
										
										
										
										
										
										
										
										
										
										
										
										
										
										

As for the blocks, the vast majority of them were created in each dwelling (or for each dwelling to order) and were known to a small number of people who belonged to a certain social or cultural community. In other cases, they were probably a kind of distinguishing feature of one house among others.

Sign systems of the Trypillia-Cucuteni community and writing

There are three periods of development in the history of writing:

the pictographic rebus-like concrete-symbolic script, which has no connection with language; there is a graphic script, isomorphic to language; phonetic script, which corresponds to the language (Karapstyants A. M., 1977., p. 239-240).

To which of these three stages of writing development can we attribute the sign systems of Trypillia-Cucuteni?

Recently, this issue has become especially relevant in connection with the culturological understanding of the Trypillia-Cucuteni phenomenon as a whole. After all, writing, according to Masson, is part of a huge "iceberg" of the culture of the first civilizations (which also includes cities and monumental architecture) (Masson V. M., 1989., p. 8-9).

For the analysis of sign systems as certain graphic "texts" we use, with some changes, the stages of research that were proposed by Starikov for the study of small Khitan scripts (Starikov VS - 1982. p. 100-109). Of all the currently known sign systems of the Trypillia-Cucuteni community of the Cl-γI stage, the Tomashivka local chronological group is the most developed one. So far, it is also the most studied group among the Trypillia-Cucuteni oikumene. Particularly extensive excavations in the villages of Talianki and Maidanetske allow the most complete study of the sign system at the synchronous level. Also, the excavations carried out at different times in the settlements of this group, which cover all stages of its development allow us to study it in diachrony. Therefore, for example, we will focus on the sign systems of Talianki and Maidanetske.

1. The length of the "texts".

The vast majority of all known signs of the Tomashivka group are inscribed on the dishes. As an exception, the signs occurred on a zoomorphic vessel in the form of a bear, a model of housing (?), a sleigh, which we do not observe in other sign systems. They were located either vertically or horizontally. The length of groups of characters is small - from one to three (rarely four) different characters.

2. Composition and types of graphic complexes and pauses.

Each image consists of a different number of graphic complexes - simple and complex, often located one below the other. These complexes are separated by either empty spaces or the same image by a sign that enters the block and is drawn in the upper tier. Graphic complexes (blocks) on the vessel, usually two or four (rarely three), are applied on opposite sides. Sometimes they are separated by images of signs in the upper tier of the painting and elements of the general scheme of the painting in the lower tier.

3. The composition of graphic complexes.

A simple graphic expression is the basic structural unit of the sign system of the Tomashivka group (as well as other groups) and always consists of one grapheme-monogram. In images, the grapheme-monogram stands alone, i.e. isolated from graphic complexes. Graphic complexes - polygrams are complex blocks consisting of several graphs. The number of graphemes in blocks varies from two to four. Monograms and polygrams are graphic units that are easily removed from the general scheme of painting, without violating it. Painting schemes are also hierarchically higher signs. They combine monograms and polygrams into systems. General painting schemes look like crosses (static

compositions) and swastikas (dynamic compositions), or combinations of these signs (static-dynamic compositions).

4. Polygrams and the order of their graphs.

Polygram, consisting of the specified number of graphemes, takes up more space than an isolated grapheme-monogram. Even if each graph is in most cases drawn separately (the exception is the superposition of one monogram on another), they are often located very close to each other in a clearly defined order.

5. The total number of graphs.

189 different graphemes (535 in total) were found on the dishes from the settlement of Talianki, and 280 (1002) from the settlement of Maidanetske. But if we take into account the fact that polygrams at each dwelling are unique to it and, as a rule, do not occur at other dwellings, then one should expect to find new polygrams on ceramics from dwellings that have not yet been excavated.

6. The number of graphemes.

Of the 189 different graphemes depicted on the vessels of the settlement of Talianki, 60 occurred more than once, of which 11 graphs occurred frequently (42 to 11 times). These are signs in the form of a black circle (42 characters), a ribbon filled with rows of dashes (32 characters), a vertical ribbon filled with a grid (30 characters), a moon-shaped sign (20 images), a plant (17 characters), a lenticular oval, filled with an oblique grid (14 characters), horizontal lines on the handles (14 characters), painted lenticular oval (13 characters), lenticular oval with wavy negative stripes inside (11 characters), ribbon filled with horizontal lines (11 characters).

Among the 72 counts of the Maidanetske settlement that occurred more than once, 11 belong to the frequently used ones (from 157 to 13 times). They are almost completely similar to this type of graphemes from Talianki. However, there are some differences in their quantitative use. The most common monogram was in the form of a black circle - 157 characters. In second place - a ribbon filled with horizontal lines (79 characters), a vertical lenticular oval filled with an oblique grid (51 characters) - in third place. The fourth place is occupied by graphemes in the form of a plant and the moon (50 characters each), 48 times there was a sign in the form of horizontal lines on the handles - 5th place, a quadrilateral filled with vertical lines, 26 times (6th place), a vertical ribbon filled with a grid, - in 7th place (happened 19 times). Next in several uses are signs that were not frequently used in Talianki. This is an image of two plants (17 characters), a ribbon filled with rows of dashes (15 characters) - often used in the sign system Talianki and a moon-shaped sign with dashes (13 polygrams).

7. The structure of polygrams and features of their application.

Most often, the polygrams of the Tomaszow group were formed by vertical montage and the image of two identical signs on the sides of another, central grapheme. In Talianki, 83 polygrams were formed by a vertical mounting, 53 of them different in graphics, the image of the same signs on the sides of another - 65 polygrams (25 different in graphics). In Maidanetske, polygrams were most often formed by means of depicting identical signs on the sides of another. Thus, 125 polygrams (36 different) were formed. Vertical mounting was also used frequently. He formed 86 polygrams (55 different). It is in such polygrams, in our opinion, that the key to their meaning should be sought. According to Eisenstein, one

of the most prominent Soviet film directors and theorists, the editing of images of objects can convey any complex idea and at the same time corresponds to the course of associative thinking, where the verb is born from the collision of two results - the initial and final. The Austrian logician Wittgenstein also believed that in every linguistic picture of the world the coupling of two objects conveys the relationship between them (that is, corresponds to the content of the verb) (Ivanov V. S., 1978., p. 34).

In light of the above, let's consider the vertical connexion of a polygram consisting of a lenticular oval filled with an oblique grid, and a plant (or plants) located above it. This sign is important for understanding polygrams created by vertical and vertical-horizontal mounting. The already mentioned interpretation of the lenticular oval as a sign of the grain from which the plants grow (Videyko M. Y., 1989., p. 47-48), allows us to interpret this block as a combination of beginning (grain) and end (plant), which may correspond to the verb meaning "grow", "grows". Its repetition is probably a kind of magical action aimed at plant growth. In general, recurrent repetition is an important feature of all magical actions (Malinowski B., 1992., p. 109). Thus, vertical and vertical-horizontal blocks (as well as polygrams close to them in structure) should be perceived from the bottom up. If our observation is correct, then, we are not dealing with phonemic decoding, as would be the case of actual writing, and with the interpretation of icons. We do not know the languages of the people who used them. Regarding a small number of identical polygrams, most of which occurred once, rarely two or three times, it should be mentioned that many traditions are characterized by a kind of communicative selection in the field of sacred and magical language. The appeal to God (spirit, etc.) while not being heard (seen) by those to whom it does not concern (Kaligin V. P., 1986., p. 58).

Let us return to the description of polygram structures. Horizontal mounting was also used quite often. There were 53 polygrams in Talianki (14 different) and 66 polygrams in Maidanetske (28 different). Placing the same characters horizontally may have created pointers to the set. Further, the use of means of installation of two well-studied sign systems of the Tomashivka group differs. Thus, the fourth most numerous means of editing in the sign system of Talianki is vertical mounting with two identical signs on the sides of the central (lower) grapheme (11 polygrams, 9 different) (Talianki, cat. №147-155); vertical-horizontal installation (11 signs, all different) (Talianki, cat. №136-146); images of different characters next to each other (11 characters, 9 different ones) (Talianki, cat. № 156-164). In addition to these means of forming signs, the following montages took place in Talianki: images of identical signs on bowls - 11 polygrams (7 different) (Talianki, cat. № 165-171), superimposition of a sign on a sign (10 polygrams, 7 different) (Talianki, cat. № 178-184), the formation of cross-shaped and swastika-like polygrams - 5 blocks (all different) (Talianki, cat. № 173-177), vertical-horizontal installation and two signs on the sides of the central grapheme - 2 polygrams (Talianki, cat. №185-186). The montage of the polygram by overlapping and placing two identical signs on its sides happened here once (Talianki, cat. № 187). The formation of polygrams by superimposing one sign and another in combination with vertical editing also happened once (Talianki, cat. № 183).

Images of identical signs in the centers of bowls (6 different ones) occurred 28 times in Maidanetske (Maidanetske, cat. №273-278); cruciform and swastika-like polygrams occurred 16 times (all different) (Maidanetske, cat. № 218-232); 21 signs (19 different) were formed by vertical-horizontal installation (Maidanetske, cat. № 178-196). Through superimposing one sign-on another 19 signs (13 different) were formed (Maidanetske, cat. № 233-245), 17 polygrams (15 different) (Maidanetske, cat. № 199-211) were formed by the image of different signs. 12 different signs were formed by placing two identical signs on

the sides of another and vertical installation, (Maidanetske, cat. №246-257). Editing of images of animals in Maidanetske happened 7 times (in Talianki - 1 time) (Maidanetske, cat. № 266-272). Editing in the form of combinations of images of two identical signs on the sides of the other and vertical-horizontal arrangement of signs happened 8 times (Maidanetske, cat. № 258-265). The combination of marking on the sign and vertical mounting happened twice (Maidanetske, cat. № 279-280).

Monograms and polygrams of the Tomashivka group (as well as other groups) represent the active development of pictography. Icons consisting of images of the moon, grain, water, plants, animals, and a large number of symbolic signs were part of complex compositions that have not yet gone beyond the ornamental schemes that combined them into a system, they have not yet acquired a linear view and not schematized.

Table 52: Catalogue of signs on painted pottery from Talianki

1 42	2 14	3 30	4 3	5 3	6 1	7 3	8 1	9 17	10 1	11 14	12 13	13 11
14 9	15 8	16 6	17 3	18 2	19 1	20 11	21 11	22 10	23 3	24 9	25 2	26 4
27 7	28 4	29 1	30 3	31 1	32 3	33 1	34 1	35 1	36 2	37 1	38 1	39 1
40 3	41 1				42 1	43 1						
44 7	45 6	46 2	47 1	48 1	49 1	50 1	51 1	52 5	53 1	54 1	55 1	56 3
57 2	58 1	59 1	60 1	61 1	62 1	63 2	64 1	65 1	66 1	67 1	68 1	69 1
70 3	71 1	72 4	73 1	74 1	75 1	76 1	77 1	78 1	79 3	80 1	81 2	82 1
83 1	84 1	85 2	86 1	87 1	88 1	89 1	90 2	91 1		92 1	93 1	94 1
95 1	96 1											
97 1	98 1	99 1	100 1	101 1	102 1	103 1	104 20	105 5	106 4	107 2	108 1	109 1

Table 53: Catalogue of signs on painted pottery from Taliangi (continued)

110 1	111 7	112 1	113 1	114 6	115 1	116 1	117 1	118 1	119 1	120 1	121 3	
122 32	123 1	124 1	125 1	126 1	127 4	128 2	129 1	130 1	131 1	132 1	133 5	134 1
135 1												
136 1	137 1	138 1	139 1	140 1	141 1	142 1	143 1	144 1	145 1	146 1		
147 3	148 1	149 1	150 1	151 1	152 1	153 1	154 1	155 1				
156 2	157 2	158 1	159 1	160 1	161 1	162 1	163 1	164 1				
165 5	166 1	167 1	168 1	169 1	170 1	171 1						
172 5	173 1	174 1	175 1	176 1	177 1			178 2	179 2	180 2	181 1	182 1
183 1	184 1				185 1	186 1		187 1		188 1		189 1

Table 54: Catalogue of signs on painted pottery from Maidanetske





















































												
1 157	2 79	3 51	4 9	5 7	6 7	7 5	8 2	9 2	10 2	11 1	12 1	13 51
												
14 3	15 1	16 1	17 48	18 26	19 19	20 6	21 1	22 1	23 2	24 11	25 4	26 2
												
27 10	28 1	29 6	30 4	31 2	32 2	33 8	34 7	35 1	36 1	37 1	38 1	39 1
												
40 3	41 1	42 3	43 1	44 2	45 2	46 1	47 1	48 1	49 1	50 6		
												
51 1	52 1	53 1	54 1	55 1		56 1						
												
57 4	58 1	59 1	60 1	61 1	62 1	63 1	64 1	65 3	66 1	67 1	68 1	69 2
												
70 1	71 1	72 1	73 4	74 1	75 6	76 2	77 1	78 1	79 2	80 2	81 2	82 2
												
83 3	84 3	85 3	86 1	87 1	88 1	89 1	90 1	91 1	92 1	93 1	94 3	95 3
												
96 1	97 1	98 1	99 1	100 1	101 1	102 1	103 1	104 1	105 1	106 1	107 2	108 2
												
109 1	110 1	111 1										

Table 55: Catalogue of signs on painted pottery from Maidanetske (continued)

112 50	113 13	114 10	115 5	116 1	117 1	118 1	119 1	120 1	121 1	122 3	123 1	124 1
125 1	126 1	127 4	128 1	129 1	130 1	131 1	132 1	133 1	134 1	135 8	136 3	137 1
138 1	139 1	140 1	141 1	142 2	143 1	144 1	145 1	146 1	147 1			
148 12	149 3	149 3	150 1	151 1	152 1	153 1	154 1	155 1	156 1	157 1	158 1	159 1
160 1	161 1	162 3	163 5	164 1	165 1	166 1	167 1	168 17	169 1	170 1	171 1	172 1
173 1	174 1	175 1	176 1	177 1								
178 2	179 1	180 1	181 1	182 1	183 1	184 1	185 1	186 1	187 1	188 1	189 1	190 1
191 1	192 1	193 2	194 1	195 1	196 2			197 1	198 1			
199 1	200 2	201 1	202 1	203 1	204 1	205 1	206 2	207 1	208 1	209 1	210 1	211 1
212 7	213 6	214 3	215 1	216 1	217 1	218 1	219 1	220 1	221 1	222 1	223 1	224 1

Table 56: Catalogue of signs on painted pottery from Maidanetske (end)

225 1	226 1	227 1	228 1	229 1	230 1	231 1	232 1					
233 3	234 1	235 2	236 1	237 1	238 2	239 1	240 2	241 1	242 2	243 1	244 1	245 1
246 1	247 1	248 1	249 1	250 1	251 1	252 1	253 1	254 1	255 1	256 1	257 1	
258 1	259 1	260 1	261 1	262 1	263 1	264 1	265 1					
266 1	267 1	268 1	269 1	270 1	271 1	272 1						
273 8	274 7	275 9	276 2	277 1	278 1			279 1		280 1		

Development of the pictographic system of the Tomashivka group.

Diachronic analysis of the sign systems of settlements of the Tomashivka group, settlements that preceded them (stage BII) and those which were related, showed that simple graphemes - monograms were already known on very archaic monuments of the beginning of the stage of Rakovets-Florești V (Popova T. A., 1989., p. 147; Todorova T. D., 1992., p.71). These are signs in the form of painted circles, lenticular painted ovals, wavy lines and ribbons, oblique crosses. In addition to simple monograms, polygraphs in the form of double moons (Rakovets) (Popova T. A., 1989., Fig. 3, 1a, 16) appeared on these monuments; black circles on the sides of the diagonal stripes (ibid., Fig. 3, 2; Fig. 5, 3 a, 36); vertical lines and black circles on both sides (Florești V) (Todorova T. D., 1992. p. 67., Fig. 4.2; P. 68. Fig. 5.3); images of the crescents of the moon on the sides of the wavy ribbon-sign of water (Rakovets) (Popova T. A., 1989., Fig. 3, 1a, 16), Florești V (Todorova T. D., 1992., p. 68., Fig. 5, 3).

The same graphic performances in the same contexts over a long period (from the beginning of the BII up to the CI) indicate the existence of a tradition in the transmission of both simple graphemes and polygrams through generations as well as their importance in the life of the population. As the analysis showed, the means of editing were also transferred, such as the arrangement of identical signs on the sides of the central grapheme, images of groups of identical and different signs, drawing one sign under another.

At a later settlement of the BII stage in Volodymyrivka, which is genetically related to previous Rakovets monuments (Chernysh E. K., 1982, p. 211; Popova T. D., 1992, p. 147), polygrams occurred, formed by vertical and horizontal mountings. This testifies to the development of the sign system over time in the direction of increasing the use of signs and the emergence of other means of their installation during the stage of BII in this region. There are two points in the genesis of the sign system of the Tomashivka group:

1. Assignment of certain specific values to simple monograms and their transmission over time, as well as the consolidation of some means of their assembly into blocks - polygrams. These processes took place within the stage of BII, at the end of it (Nebelivka group) and CI. Simple monograms at the CI stage were used very often and occurred at almost every dwelling.

2. Appearance (especially at the CI stage) in each house of a certain number of polygrams, which are not present in the neighboring buildings. The vast majority of them happened once. This indicates that their consolidation and mass use, as was the case with simple graphemes, have not yet taken place. The process of development of the sign system was interrupted by some phenomena that caused the disappearance of the Tomashivka group.

Autochthony of pictography of the Trypillia-Cucuteni community.

The Trypillia-Cucuteni sign systems have 68 signs, which find formal analogies in the early Sumerian pictography and consist of 891 graphemes (Falkenstein A.). These include, for example, the following signs: a sign in the form of a star, which in later Sumerian writing meant "sky", "god" - An, Dingir and was placed before the name of the gods (Dyakonov I. M., 1983., p. 115); the sign in the form of a plant in the Sumerian script had the meaning "barley" and read "more" (Dyakonov I. M., 1983., p. 115); the sign in the form of a quadrilateral filled with a straight grid "e", in Sumerian texts had the meaning of a house (Wyman A. A., 1979., p. 58). The same signs can be found in Mediterranean cultures. For example, the sign in the form of a star occurs on things of the Cretan-Mycenaean civilization and among the Egyptian hieroglyphs, where it had the meaning "star" (Livshits I. G., 1930., p. 229). The sign in the form of a plant also occurs among the images of the Aegean world and Egyptian hieroglyphics.

Thus, these graphemes belong to those that have a universal character (Reeker P., 1991., p. 312) and arise independently in each culture due to its simple graphics and, in the case of creating signs-icons, copying the surrounding objects or phenomena. The sign systems of the Tomashivka group (as well as other local chronological groups of the Trypillia-Cucuteni community) have nothing in common with the prior Balkan pre-writing systems. In some cases, those systems have already come out of ornamental schemes, their signs have already been depicted in the form of linear "inscriptions" on plates, lids of dishes, its walls and bottoms, and so on. Graphically, they are no longer detailed but are schematic signs (Winn M. M. S., 1981., p. 20-40). All these phenomena are almost not observed in the Trypillia-Cucuteni sign systems.

All this indicates that the symbolic systems of the Trypillia-Cucuteni community developed independently and represent another center of development of pictography. Here, it likely developed primarily as a means of magical communication with higher powers. As noted by Karapetyants, communication with spirits is the first attempt to transmit information in time (Karapetyants A. M., 1977., p. 242). In general, the first pictographic and ideographic systems were not real writings, that is, a graphic transmission of language. As noted by Dyakonov on the early Sumerian icons, such signs are still impossible to convey every word of the language, to distinguish cases, persons, and other grammatical forms of words, to suggest their sound in each case, even to distinguish one word from another similar to it, even distinguish one word from another similar to it in meaning. Each sign was rather a hint to the speaker, a means for better memorization and reproduction of some messages (Dyakonov I. M., 1983., p. 112). These remarks are even more true for the signs of the Trypillia-Cucuteni pictography.

Sign systems as an index of relations “society - higher powers”.

In the previous parts of the work, the results are obtained, which allowed confirming the interpretation of the Trypillia-Cucuteni sign systems as magic icons. We trace the ratio of the total number of signs used and “table” utensils of the Trypillia-Cucuteni community at the synchronous and diachronic levels from stage BI to CII-γII to obtain data on the intensity of semiosis at different times and in different regions of the oikumene, as well as the study of phenomena that accompanied the development of sign systems. Histograms are made on this basis. They indicate the ratio of signs and utensils, as well as the number of uses of red and white paints (histograms below) in the paintings. It should be noted that only the utensils on which the painting was well preserved were analyzed. But the state of preservation of the painting is different, so the indicators included in the histograms are not absolute, but rather indicate trends in the symbolic activities of the population of different regions and local variants of community.

Histograms are compiled according to the degree of probability while showing indicators from those monuments with which the authors were lucky to work directly. These are usually well-studied dwellings that have been explored recently. Ceramic complexes are analyzed here by “dwellings”, which allows us to trace with high probability the phenomena that interest us. Histograms 1 and 5 show those ceramic collections that cannot be studied by “dwellings”. These are either long-published monuments (for example, Shipintsi B, Koshylivtsi Oboz, Târgu Ocna-Podei) or mixed collections from old excavations that were severely damaged during the war (for example, Sushkivka, Tomashivka, Petreny). The same histograms include indicators of analysis of painted pottery from Ofatinți, Majaky, and Usatove cemeteries, as well as Usatove-type burials and other monuments, whose ceramic material was studied in a mixed state. The indicators of the published ceramic complexes are also included here, they are few, but it seems that they can also be used in our research, at least as an auxiliary source. These are dishes from Valea Lupului II, Bilche Zolote Park III, and Bilche Zolote Verteba I.

The histograms indicate a small number of signs in the sign system of the middle stage of the BII in the Upper Dniester Nezvysko III (ratio 0.2) (histogram 4, №1). Nonetheless, the red (37 %) and white (10 %) (along with black) (histogram 7, №1), which were sacred to many archaic cultures, are widely used in the paintings of this settlement. (Toporov V. N., 1987., p. 216). In the middle of the Bug basin, within the BI stage, a small number of signs (ratio 0.3) and a significant number of dishes painted with white (22 %) and black paints are also visible in the paintings of Voroshylivka dishes, which is explained by the migration of the population - the bearer of Upper Dniestern traditions. (Gusev O., 1993., p. 17). The settlement of Volodymyrivka represents the interfluvium of the Sob and Sinyukha rivers in the middle of the BI stage. Its sign system consists of a relatively large number of signs (hist. 6). In the sign system of the settlement of Middle Dniester at the end of BI Konovka more signs are used (hist. 2). Ornamentation of utensils of this settlement contains elements of both Petreny and Shipintsi traditions (Shmagliy M. M., Ryzhov S. M., Dudkin V. P., 1985., p. 51). In the east, the monuments of the Nebelivka group Pischana and Kolodyste had a large number of signs (hist. 1.6) (ratios 0.7; 0.8). Thus, in the settlements of the BI stage, which were located on the periphery of the territory occupied by the cultural community, a significant semiosis was observed. It was characterized either by increased use of signs, as was the case in the far east (Volodymyrivka), or by the use of sacred colors in paintings, as in the northeast of the oikumene (Nezvysko III). Significant semiosis (use of white paint) is also associated with migration

processes in the Middle Bug basin (Voroshylivka, Sosny), as well as in the area of contact of two traditions - Shipintsi and Petreny in the Middle Dniester (Konovka).

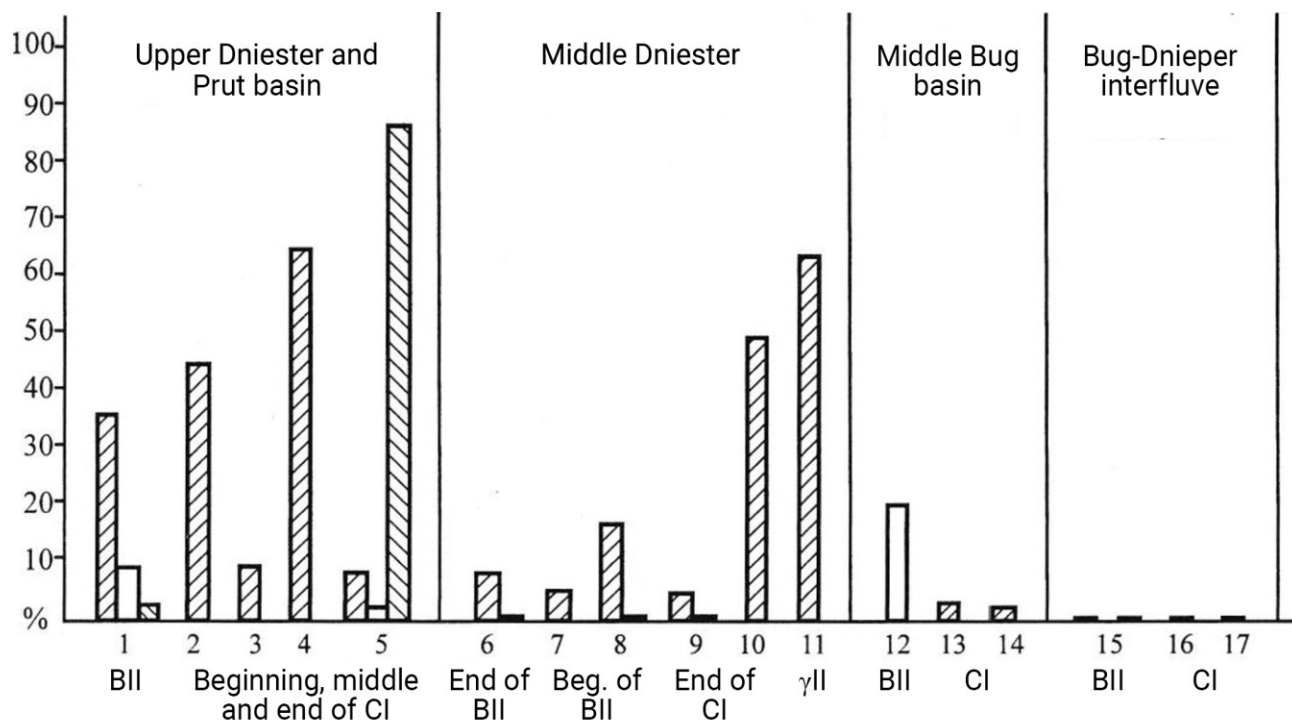

Histogram 4

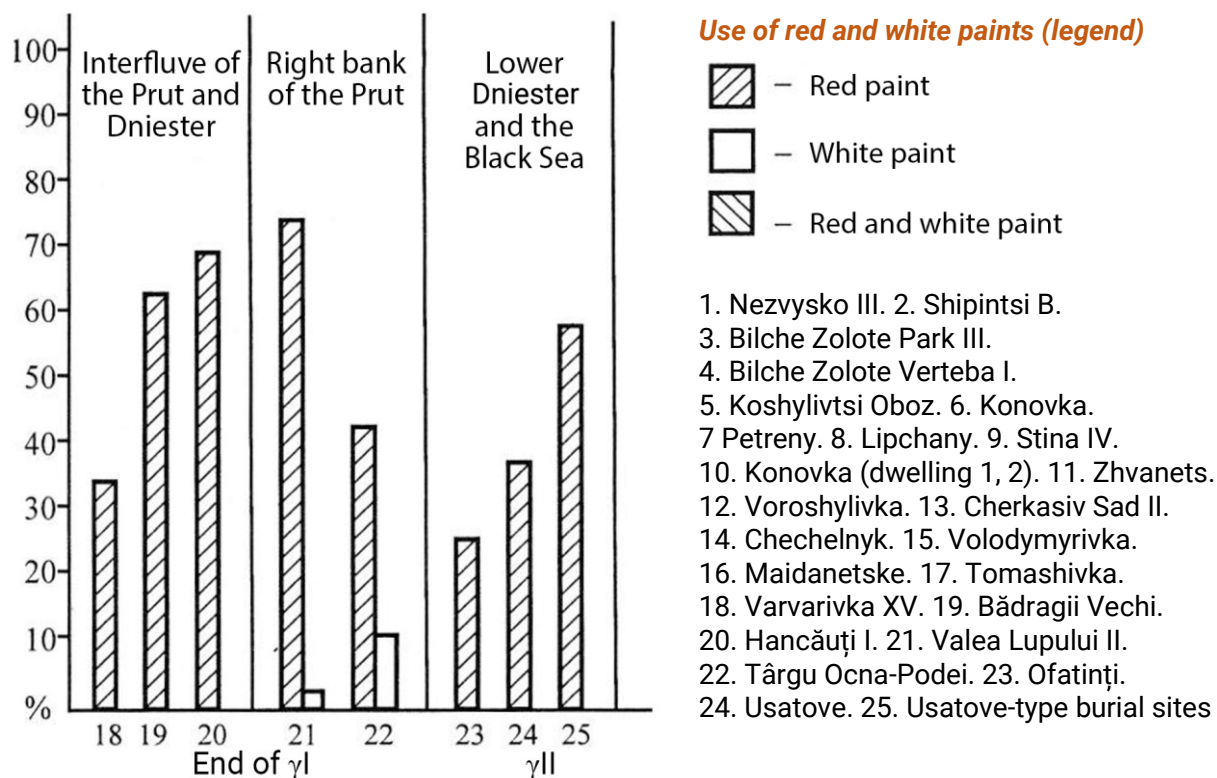

Histogram 5

Hence, the increased creation of signs or the significant use of red and white colors (or two at the same time) is characteristic of situations of heightened tension in society, associated with the placement on the periphery or contact with other traditions. At the CI-γI stage, the number of characters in some sign systems decreases compared to the end of the BI stage. Thus, in the settlement of Bernashivka the number of signs is small (hist. 2) (0.7). But its northern neighbor, the settlement of the upper Prut basin - Shipintsi B (hist. 1. № 2) uses a large number of signs and red paint in the paintings (histogram 4, 2) (45 %). In the southern eponymous settlement of the Petreny group, the number of signs is large (hist. 4), which may be explained by the strong remnants of the traditions of BI, many of which are on his dishes. In the settlements of the middle Bug basin of Cherkasiv Sad II and Chechelnyk signs, in comparison with their number in Petreny and Shipintsi, are fewer (hist. 3) (0,6; 0,7). And in the settlements of the Tomashiv group of phase II their number is traditionally significant (hist. 1. № 7 and 8) (Sushkivka - 0.8; Dobrovody - 0.7).

Starting from the middle of the CI-γI stage, the number of signs used begins to gradually increase throughout the territory occupied by the cultural community. On histogram 2 this phenomenon can be seen in the Middle Dniester in the sign system of Lipchany (0.8), and in the interfluvium of the Sob and Sinyukha rivers - in the ceramics of the settlement of phase III of the Tomashivka group of Maidanetske (hist. 8) and Talne II. №9). In the west of the oikumene, on the Right Bank of the Prut, this phenomenon is first observed in the sign system of Valea Lupului II (hist. 5. №1 (2, 3) and, a little later, in Northern Moldova - in the settlement of Varvarivka XV (hist. 3) (0,8) and the Upper Dniester - in Bilche Zolote Verteba I (hist. 5. № 2) (1,8). The growth of the number of signs begins to reach its apogee at the end of the CI-γI stage. There are fewer of them on the monuments of the Bădragii type of the Middle Dniester - Konovka (site 1, 2) (hist. 4) (0,8). The largest number of signs in the settlements of this time occurred on utensils from the settlement of Hancăuți I (hist. 4.) (1, 3). In the symbolic systems of two monuments, one of which is located in the northwest, in the Upper Dniester - Koshylivka Oboz, and the other - in the west, on the Right Bank of the Siret – Târgu Okna-Podei is used more, compared to other settlements of this time, the amount of white paint (12 %) and a small number of characters (0.5; 0.8) (hist. 5, №5, 4, hist. 2a. №22). As we can see, the growth of semiosis here followed the same path as within the BI stage - not through the use of signs, but through the use of white (and red - in the case of Koshylivtsi Oboz) paint (87 %).

In the monuments of the end of the CI-γI stage, in addition to a larger number of signs than in the previous time, there is also a sharp increase in the use of red paint in the paintings of the dishes (histograms №1 a, №2a). Besides, at this time one can observe a return to symbolic expressions, which were often found in stage BI or even more archaic sign systems. At the stage of BI and CI-γI, such signs are practically absent, or they are found in very small quantities (literally only some isolated cases of such finds are known).

One of the manifestations of this is the return to the painting of utensils from the crown to the bottom or below the "spines". Such a painting appears at the end of the CI-γI stage in the settlements of Northern Moldova (Varvarivka XV) and the Right Bank of the Prut (Valea Lupului II), as well as in the later settlements of the Bădragii type – Bădragii Vechi, Hancăuți I, Konovka (site 1, 2), where when depicting the painting of utensils slightly below the edges, which is typical of the paintings of the CI-γI stage, there are utensils painted either completely from the crown to the bottom, or much below the edges. Before that, at least at the beginning and end of the middle of the CI-γI stage, such a painting (except for a few

finds of one cup in Talianki and another cup in the Chechelnyk-type settlement of Kyrylivka) did not happen. Areas of painting utensils of this period are located from the crown or necks and reach just below the ribs. Instead, at stages BI and BI-BII (according to Vinogradova N. M.), the dishes were painted completely - from the crown to the bottoms - or left small areas near the bottoms unpainted. At the end of the CI-γI stage, a return to the conditionally realistic images of snakes can be observed in the sign systems of the settlements of the right bank and the left bank of the Prut and the Upper Dniester. They merge in the contexts of use with the still widespread wavy ribbons - signs of water. Previously, there were only a few conditionally realistic images of snakes. For example, in a large ceramic complex from the Bernashivka settlement of the CI stage, only three vessels with such images are known.

Thus, the masters who painted dishes referred to even older concepts, namely the ornamentation of stage A. In the iconic systems of settlements of that time, conditionally realistic images of snakes are quite common, although they are not made of paint, but, like the whole ornament, the technique of in-depth carving on wet clay (Zbenovich V. G., 1991., p. 21., Fig. 45). At the stage of CII-γII elements of the sign systems of earlier societies of the Trypillia-Cucuteni community (stages BI, BI-BII, and sometimes, as in the case of the sign "snake-water", and older) completely replace the previously dominant sign system of stage CI-γI. In addition to painting schemes, the shapes of utensils, to which they were characteristic, also disappear.

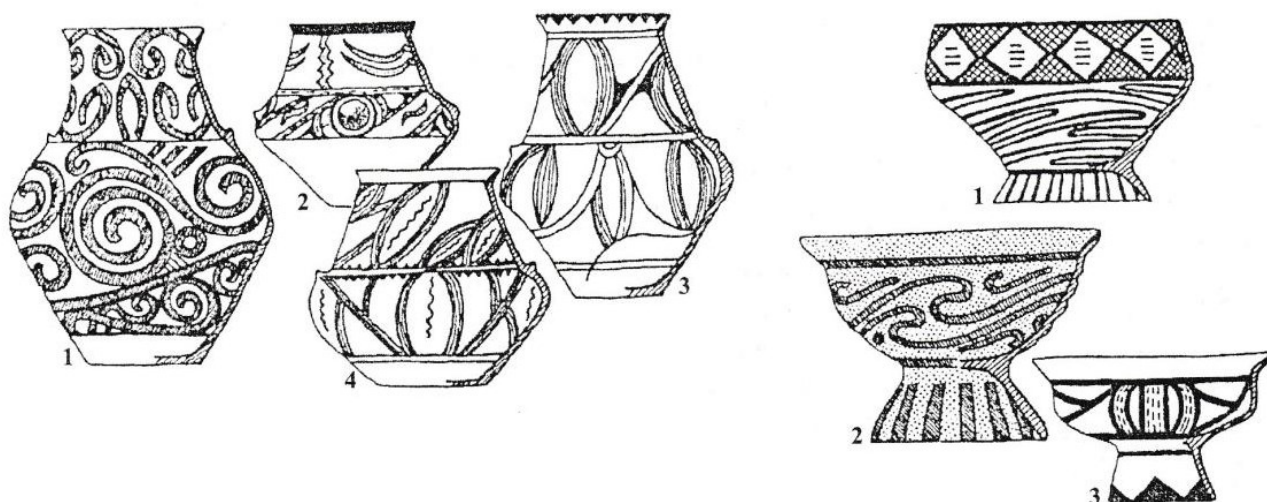

Figure 45

They are being replaced by new forms, some of which find analogies in rather archaic monuments. As an example, we will give ware with high cut-conical mouths and stickings at their bases, on trunks. Dergachev drew attention to the fact that this form of utensils is already found on monuments with boyano-like features of the Pre-Cucuteni settlements of Romania and, having undergone several transformations, survives to the stage of CII-γII, where it becomes widespread (Dergachev V. A., 1980., p. 80) (Fig. 45).

Around this time, utensils appeared on pallets, previously unknown at the stages of BII and CI, except for the findings of fragments of such utensils in the settlements of Bernashivka (1 copy) and Valea Lupului II (1 copy). The appearance of wide-necked forms of utensils on pallets is probably local. Such utensils at the end of the CI-γII stage are known only on the Right Bank of the Siret river in the ceramic complex from Târgu Ocna-Podei (Fig. 46). In the same settlement, there is another archaic form - a two-tiered vessel (Fig. 47). It is identified only at the beginning of BI among the vessels from Florești V (Todorova T. D., 1992., p. 64., Fig. 3.14; p. 69., Fig. 5.), but widespread on the monuments of the BI-BII and BI stages of the Right Bank and the Left Bank of the Prut and Dniester.

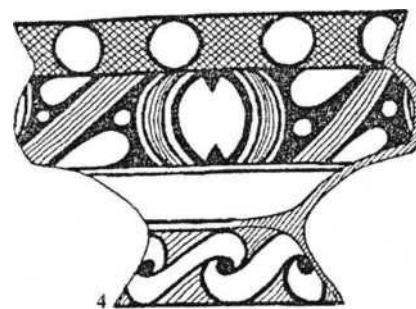

Figure 46

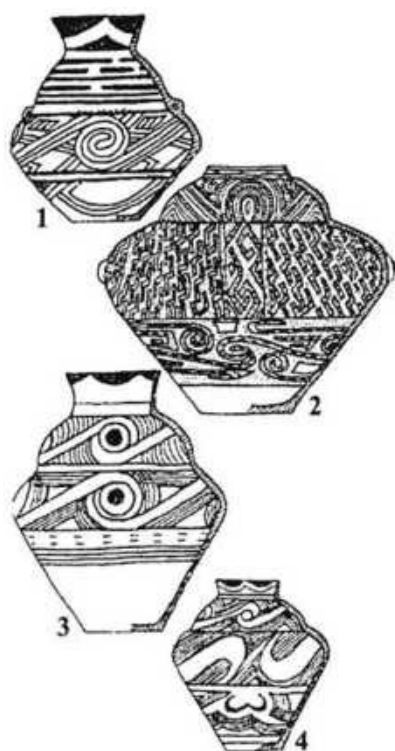

Figure 47

Returning to the archaic forms of utensils allows us to form an opinion, that the signs are not only graphic expressions (ornament) but also plastic forms (in our case - utensils). Concerning graphic expressions, the return to archaic signs at the stage of CII-γII is observed extremely widely. In the future, very often used signs in the form of a snake-water (Zhvanets, Ofatintji, Usatove, Majaky). Besides, one of the dominant schemes of the painting is lenticular ovals connected by tangents. These schemes were often used in paintings of dishes of the Bădragii Vechi, but they became dominant on monuments such as Brynzeny III - Zhvanets stage CII-γII. they were depicted crosswise inside and outside the bowls or painted in one, two, or three tiers on other types of utensils. It should be noted that ovals occur in the paintings of the CI-γI stage, but they are rarely used. Lenticular ovals, united by tangents, are much more common in the paintings of the BI and BI-BI settlements. For example, in the pottery from the settlement of this time - Trajan Dealul Fintinilor these signs are not dominant, although they occur quite often (Fig. 47).

At the stage of CII-γII, a large number of bitricangular anthropomorphic images is observed on monuments of the Brynzeny III - Zhvanets type. We have not yet come across anthropomorphic painted images of the BII stage. A small number of anthropomorphic images are known on the CI stage ware, but they are not bitricular – and have a different graphic design. Instead, among the painted ware of the stage BI-BI with Traian Dealul Fintinilor, the triangular images were found on one whole jug (2 figures) and three fragments (three figures). One vessel with such images was found in the settlement of Galaesti (Fig. 48). This suggests that on monuments of the Brynzeny III-Zhvanets type, there is a return to bitricular anthropomorphic images of the BI-BII stage, made even in a similar context - in lenticular and labris-like fields, to which Movsha drew attention. (Movsha T. G., 1991., p. 41).

Having listed some of the most striking manifestations of the return to archaic signs in the semiosis of the middle and end of the CI-γI stage as well as CII-γII, let us turn to the mechanisms to which the tradition was spread. Based on the above examples, we can say that the signs, patterns, and forms of utensils used by ancestors were of great value to the population of that time. At the BII and CI stages, they were not forgotten, as evidenced, for example, by single images of ovals on bowls, biconical and pear-shaped vessels of these stages. The tradition of painting bowls on two sides was not forgotten either, as evidenced by the finds in the settlement of Bernashivka of two bowls painted on two sides, which is not typical for painting bowls of this time. Iconic signs in the form of snakes and anthropomorphic figures were always remembered. Of course, these images are graphically different from the ancient ones. But, as noted by the researcher of the phenomena of tradition Shatsky, the possibility of maintaining fidelity to the “parents” is illusory, because it would require the impossible: to live in the same world as them (Shatsky, E., 1990., p. 300).

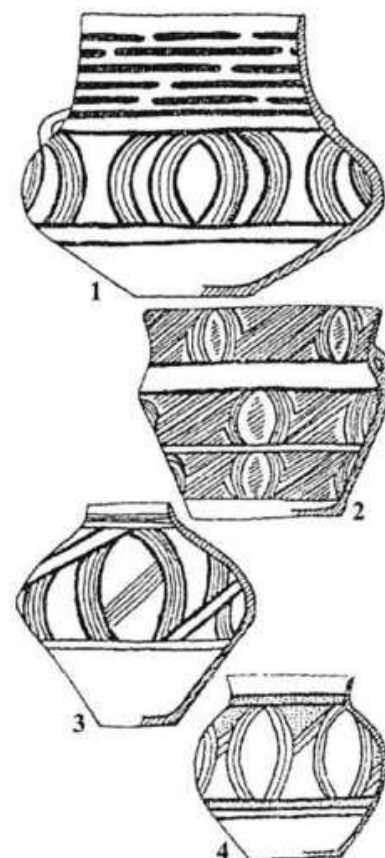

Figure 48

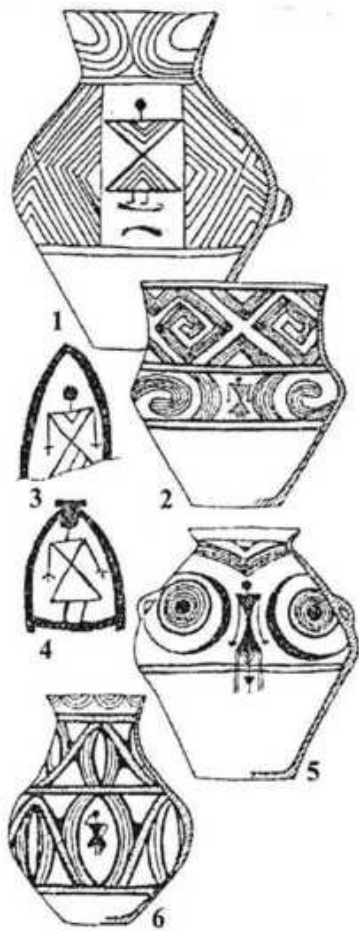

Figure 49

Interestingly, the population of the Trypillia-Cucuteni settlements of the Brynzen-Zhvanetsky, Ofatinți, Usatove, and Gordinești types used ancestral signs, which they used not so often. For example, they did not use the spiral, which is very common in BI and BI-BII paintings (except for the painted utensils of the earlier settlement of Târgu Ocna-Podei, where the spiral occurs very often). On the other hand, as already mentioned, lenticular ovals, which are rarely depicted in stages BI and BI-BI, at the stage of CII-γII become the dominant schemes of painting (together with the “grid” and curved linear compositions) (Dergachev V. A., 1980., pp. 188-190. Fig. 22-24). Perhaps this can be explained by the theory of the value of signs proposed by Charles Morris (Morris C. W., 1983., p. 181). In the paintings of the CII-γII stage, special signs, which were given special value by ancestors, were used, and by their status, they could be depicted less often. This raises the question of the reasons that caused the phenomenon of return to ancestral signs. Recently, there have been opinions in the literature that at the end of the CI-γI stage and the beginning of the CII-γII stage, some crises began to appear in the societies of the Trypillia-Cucuteni cultural and historical community. Now, the most proven are their ecological explanations (Petrenko V. G., 1989., p. 116-118; Kruts V. A., 1989., p. 124-128; Kremenetsky K. V., 1991., p. 166, 175). This crisis affected the entire ecumenism of the cultural community and caused the growth of symbolic activity, probably as a magical means of influencing nature or some forces that in the minds of the population

at the time gave the desired outcome.

But it did not bring results, which caused even greater efforts in landmark activities. They appeared in the complete abandonment at the stage of CII-γII of the schemes of painting and forms of utensils used before, and the mass reproduction of strongly transformed ancestral signs. Perhaps these phenomena were caused by the concepts of the “Golden Age”, a time when the ancestors lived in well-being and prosperity. But these signs were not effective, and the culmination of the crisis of culture was its collapse.

Thus, we can say that the secondary sign modeling system (in our case, ornamentation, and forms of utensils) is the pulse of the culture, which immediately responds to the slightest changes in it. Before the crisis begins, the number of signs used in the system is growing, their growth is a kind of indicator of the future crisis. In times of crisis, there is an almost complete abandonment of the previously dominant sign systems, though, much attention is paid to the signs of ancestors, who were endowed with a special value status. This could be proliferated by the verbal stories, such as the myth of the “Golden Age”. Thus, the weak modeling of the secondary modeling system indicates the health and stability of the society that uses it, at least on the ornamental level.

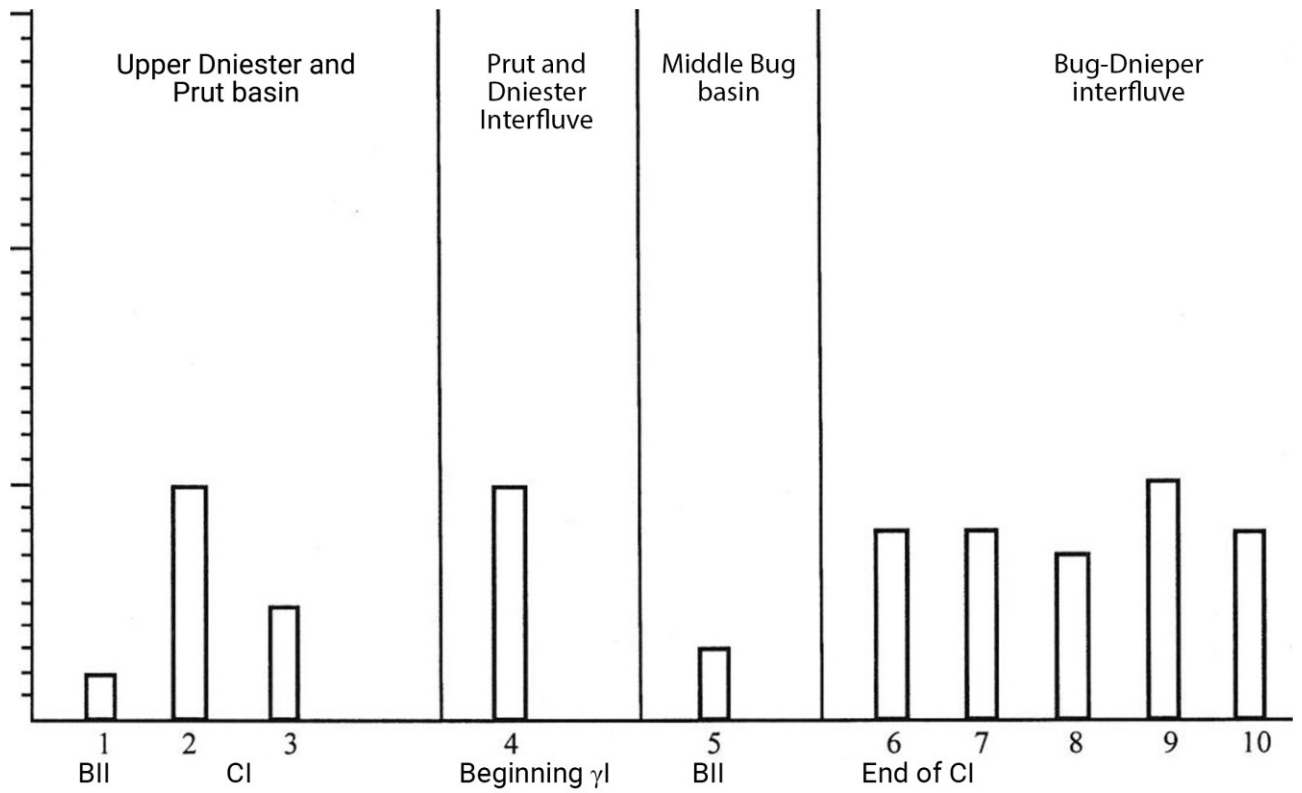

Histogram 6: The ratio of signs and painted pottery

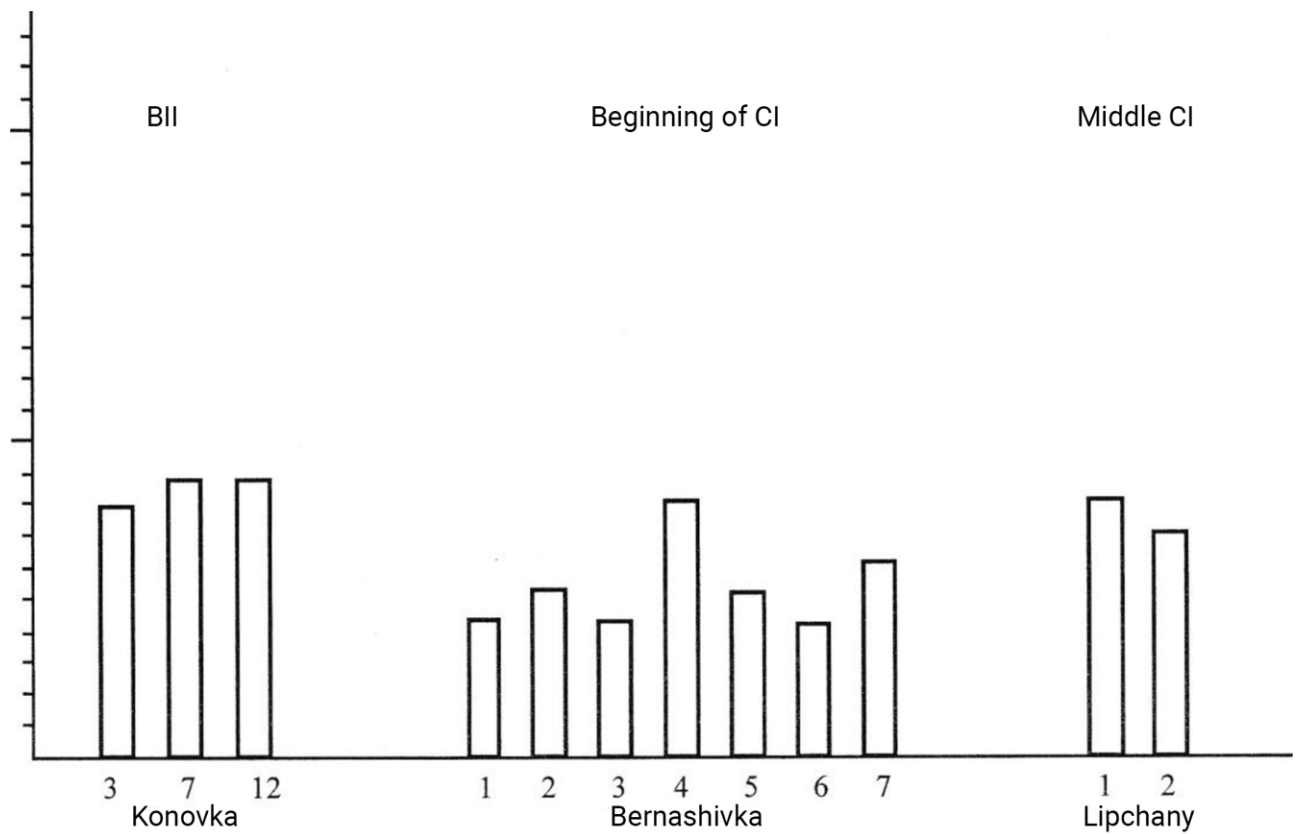

Histogram 7: The ratio of signs and painted pottery

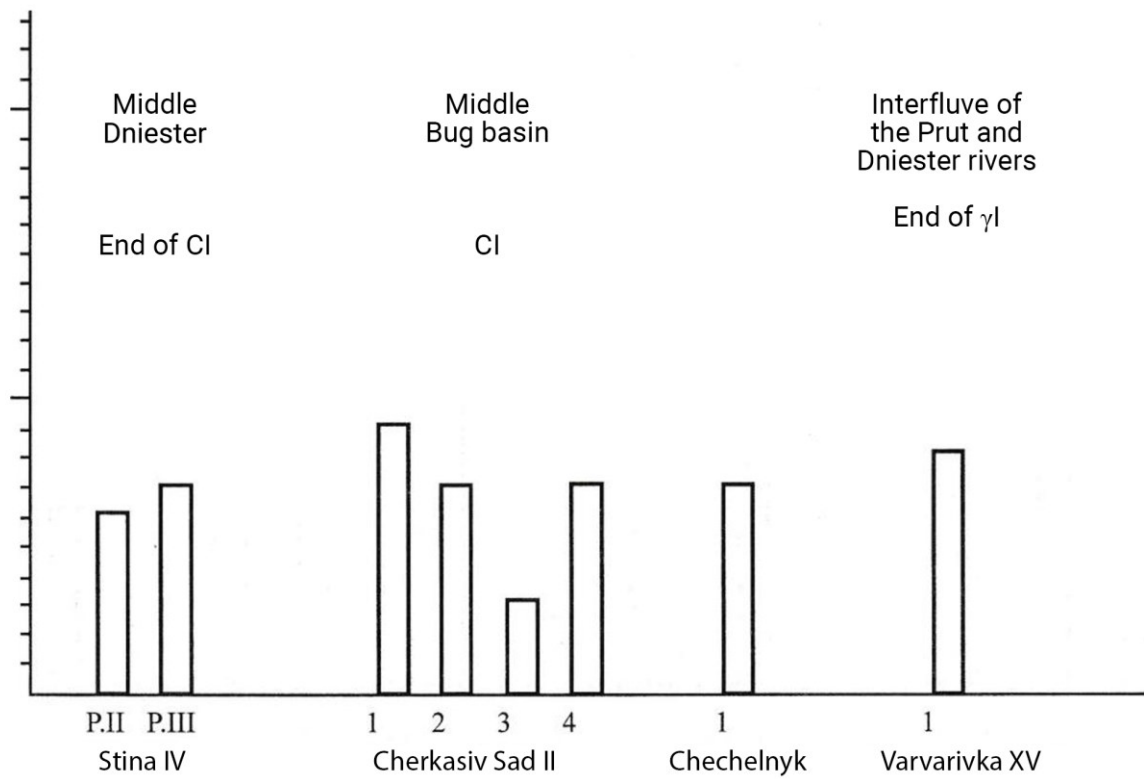

Histogram 8: The ratio of signs and painted pottery

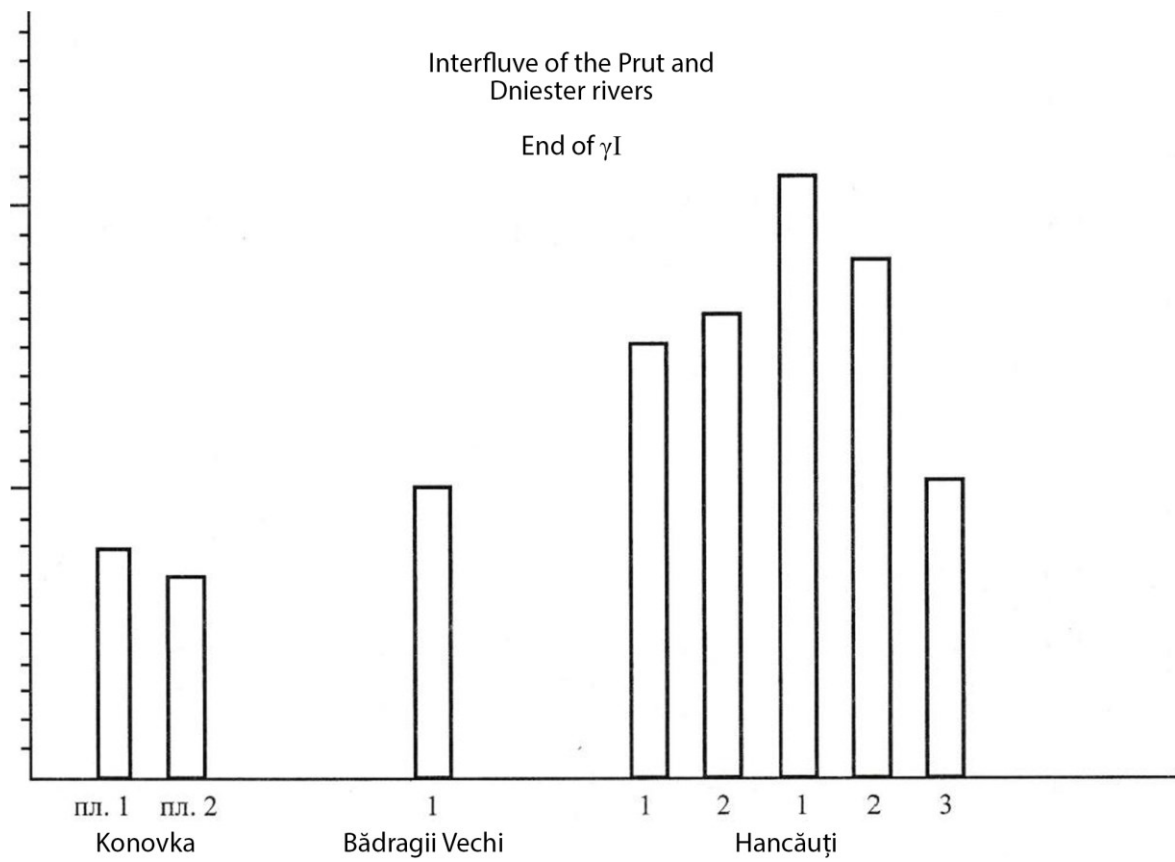

Histogram 9: The ratio of signs and painted pottery

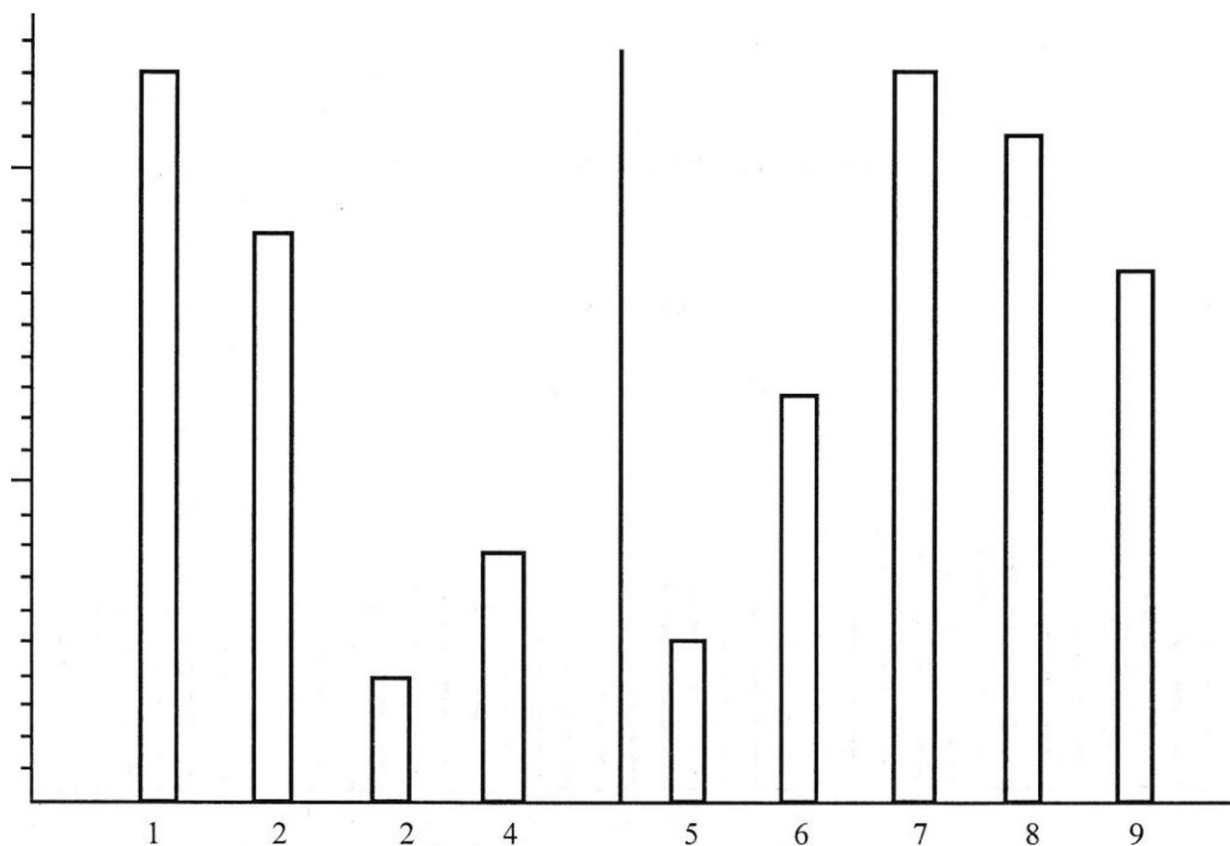

Histogram 10: The ratio of signs and painted pottery

The number of uses of signs on dwellings (legend).

1. Valea Lupului II. 2. Bilche Zolote Verteba I 3. Zhvanets. 4. Târgu Ocna-Podei. 5. Koshylivtsi Oboz.
6. Ofatinți. 7. Usatove. 8. Majaky. 9. Burials of the Usatove type.

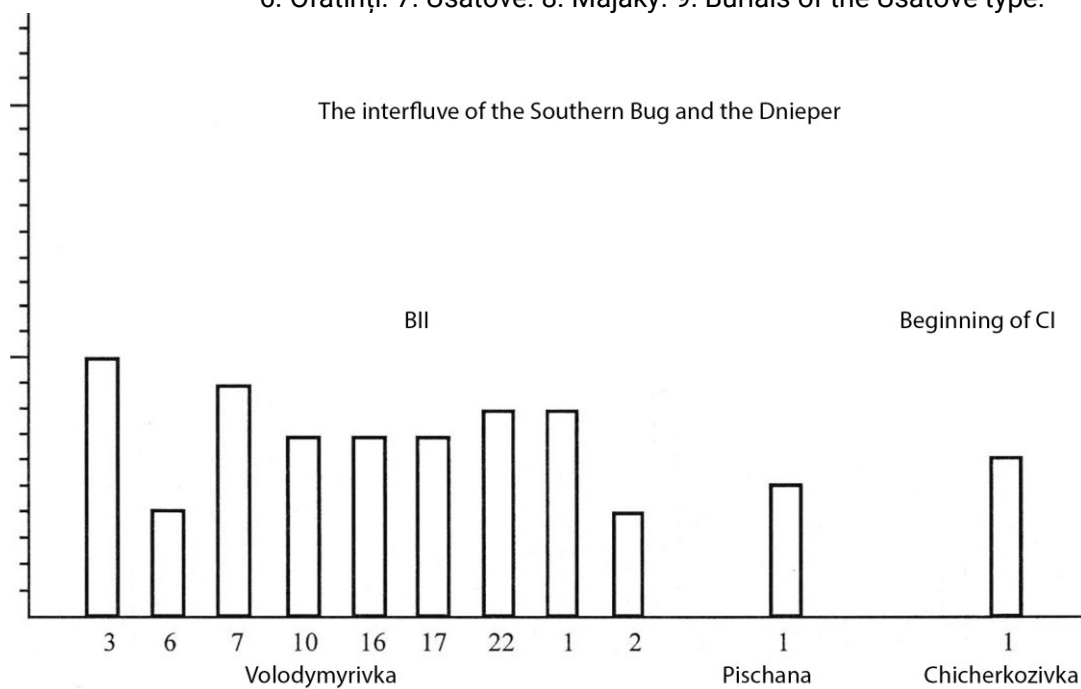

Histogram 11: The ratio of signs and painted pottery

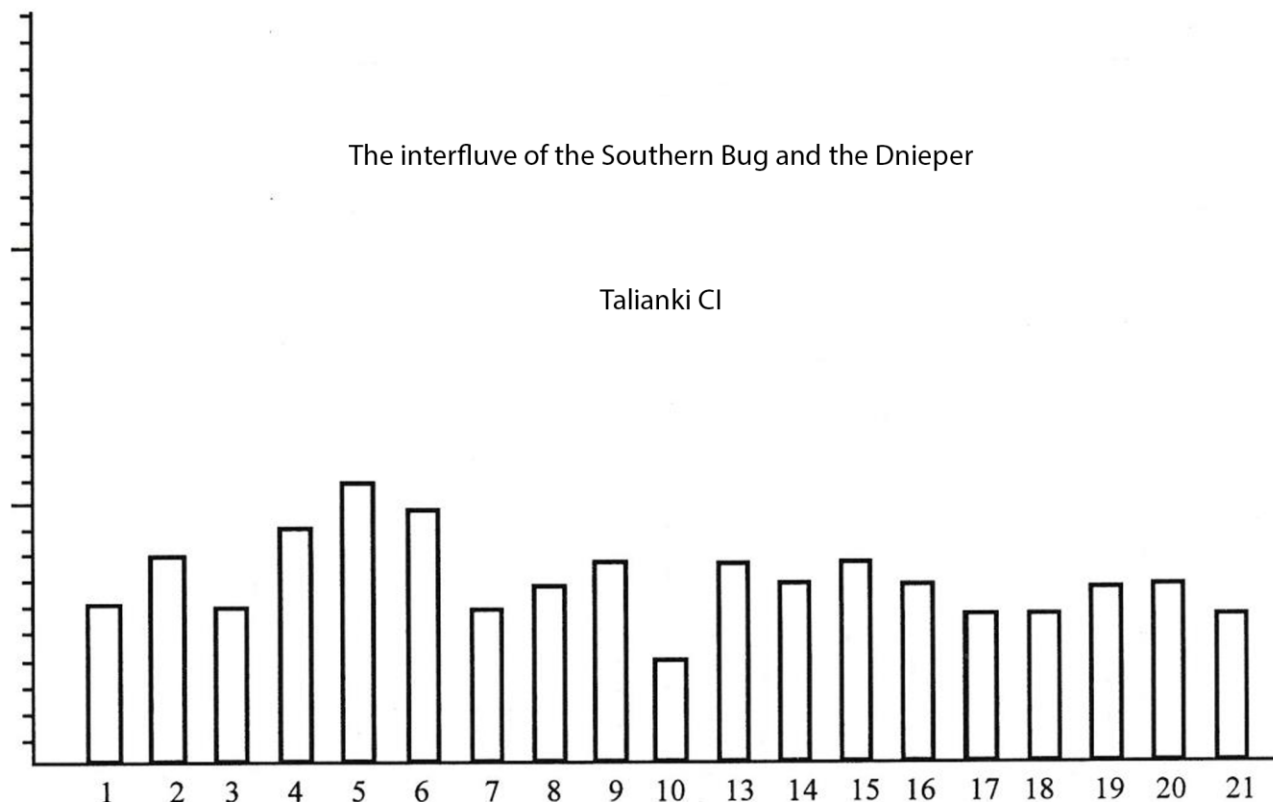

Histogram 12: The ratio of signs and painted pottery

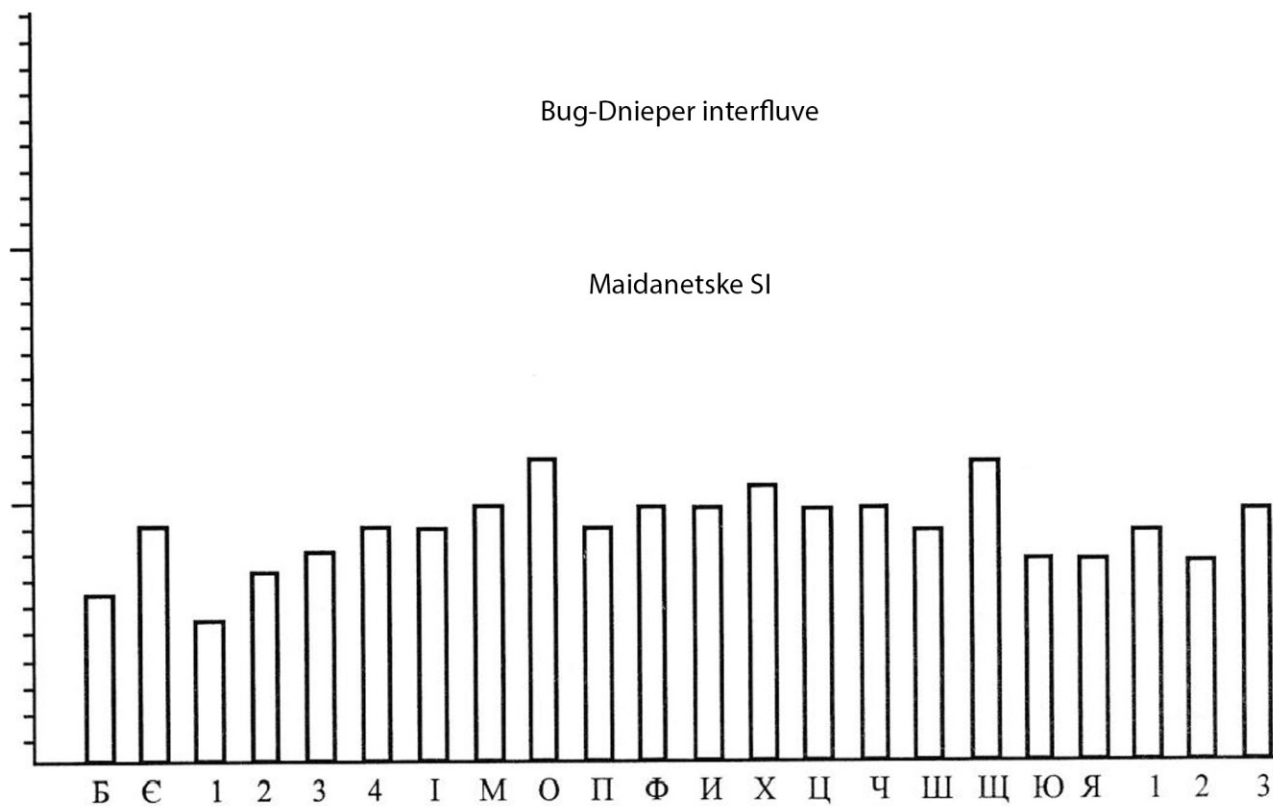

Histogram 13: The ratio of signs and painted pottery

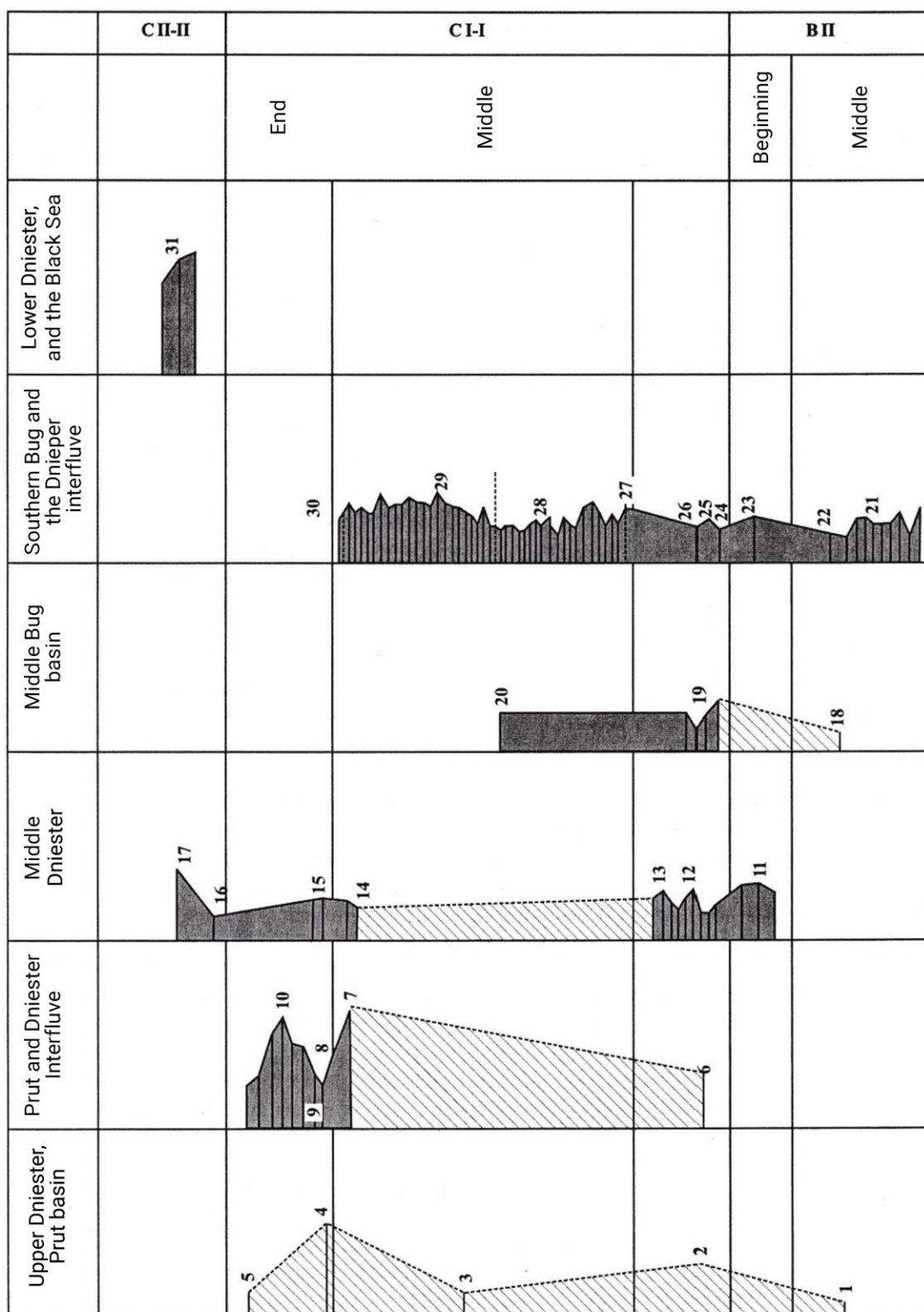

Summary table of the ratio of signs of painted utensils

1. Nezvysko III. 2. Shipintsi B. 3. Bilche Zolozhe Park III. 4. Bilche Zolote Verteba I. 5. Koshylivtsi Oboz. 6. Petreny. 7. Valea Lupului II. 8. Varvarivka XV. 9. Bădragii Vechi. 10. Hancăuți I. 11. Konovka. 12. Bernashivka. 13. Lipchany. 14. Stina IV. 15. Konovka (site 1,2). 16. Zhvanets. 17. Ofatinți burian site. 18. Voroshylivka. 19 Cherkasiv Sad II. 20. Chechelnyk. 21. Volodymyrivka. 22. Pischana. 23. Kolodyste. 24. Sushkivka. 25. Chicherkozivka. 26. Dobrovody. 27. Talne II. 28. Talianki. 29. Maidanetske. 30. Tomashivka. 31. Usatove.

CONCLUSIONS

The perception of the ornamentation of painted pottery of the Trypillia-Cucuteni cultural-historical community as a secondary modeling semiotic sign system was applied in this study, along with archaeological and structural-semiotic research methods. This made it possible to approach this phenomenon as an evolutionary-dynamic organism, where each sign enters into a paradigmatic and syntagmatic relationship with other signs. The main part of this work is devoted to the study of these relations at the diachronic and synchronous levels.

The first stage of structural-semiotic work with Trypillia-Cucuteni ornamentation, connected with operations on its decomposition, gave the chance to assign the shifting and constant elements, to make the catalogs for each investigated settlement in which quantitative indicators for each of these elements result. Comparison and correlation of the above results at the diachronic and synchronous levels allowed us to depict the trends in the evolution of sign systems.

The second stage - the study of the installation of moving elements - made it possible to understand their location on the permanent elements, the schemes of paintings, and to attain the paradigmatic chains of signs. As a result of semantic research, a minimal set of graphemes (semantic markers) was obtained, from which other signs were created. Semantic markers were transmitted in the cultural community from the beginning of BI to the end of CI-γI, while some of them were used until the end of CII-γII. Obtaining semantic markers of sign systems, studying their semantic fields as well as identifying the dynamics of their use at the diachronic and synchronous levels made it possible to approach the world of values (axiology) of the set cultural community.

Signs of the moon in different phases and states, flowing and falling water, grain, snakes, anthropomorphism, the search for the center (its marking) constitute a significant aspect of the ideology of the time. Rituals and myths belong to the ideological expressions by which (according to Greimas A. J. and Kurte J.) culture fights polysemanticism. Fragments of some of them are recorded in the ornamentation of utensils. It is possible that behind the series of moving signs obtained during syntactic research, there are ideas about polymorphism (including semantic markers), on which the myths of reincarnation were based. A large number of bright signs-icons of the moon suggests, that the main astral symbol, to which the local chronological groups of Trypillia-Cucuteni paid the most attention (Petreny, Chechelnyk, and especially Tomashivka) was the moon. The semantic fields of all markers and the symbols of crosses and swastikas were likely associated with the moon. The images of lunar icons near the ledges - "chest" (on the anthropomorphic vessels of the Tomashivka group) and on the "bellies" of jugs depicting female figures without heads (from the settlements of the Petreny group), may have reproduced the cosmogonic myth of the moon. Besides, this could signify a connection of the moon to additional symbols, for example, water, grain, which through the sacrifice of a goddess or a man (possibly through a sacred decapitation (?)), also testified to the existence of an important section of mythology such as "death - life."). Pairs of two-eyed or four-eyed creatures were closely connected with the moon, and images of them, often in several specimens, were found in almost every house at that time. In the region of Tomashivka, there were ideas about the moon as the eyes of a mythological creature or creatures whose faces were painted on dishes. The disappearance of images of signs-icons of the moon at the stage of CII-γII, among other things, indicates some important changes in the ideology of the population of this time.

The attitude to ornamentation as a sign system, the function of which, among others, is the creation, storage, and transmission of information in time and space, has caused the need for synchronous studies of the use of signs. Carrying out such work at the level of distribution of signs on each location of the large excavated dwelling of Maidanetske allowed us to determine that each house has its signs-blocks. Nonetheless, simple signs occur in every home. This may indicate that simple signs and their means of installation, including many semantic markers, were common, while blocks were created in each house (or *for* each house) and were not repeated in the surrounding structures. The same phenomenon is observed during synchronous studies of the sign systems of the Talianki and other excavated Petreny, Chechelnyk, and Bădragii Vechi settlements. The study of quantitative indicators of the use of signs at the synchronous and diachronic levels as well as observation of the phenomena that accompanied the development of sign systems, provide an opportunity to look at the dynamics of the sign system from a historical perspective. At the stage of BII (in the middle of it) quite a few signs are used in the ridicule of different territories of the cultural community. At this time there is a significant expansion of the community (inhabited by Eastern Volhynia, the Sinyukha river basin) (Kruts V. O., 1993., p. 37), migration from the Upper Dniester to the Middle Bug basin (Gusev S. O., 1993., p. 17). At the end of BI and the beginning of CI-γI the number of signs on the painted ware increases. But then, at the beginning of the CI-γI stage, it decreases compared to the previous one. At this time there is a certain stabilization in the development of society. The entire forest-steppe of Ukraine, Bessarabia, and Moldova is divided between the tribes - the bearers of a cultural community. No significant migrations were recorded.

From the middle of the CI-γI stage, the number of signs begins to grow again on all monuments and throughout the area of culture and reaches its apogee at the end. Also, in the west of the ecumenism there is a return to the sign expressions of earlier sign systems (stage BI-BII and even A), however, in a strongly transformed form. At this time some crises occur, the stability of life is disturbed. On the one hand, new cultural phenomena appear and the transformation of existing sign systems begins (Valea Lupului II, Varvarivka XV, Shura I), and on the other hand, entire local groups in the Sinyukha river basin (Tomashiv group) and the Southern Bug disappear. Transformation of existing at the end of the stage CI-γI sign systems leads to the creation at the stage of CII-γII of local chronological groups. At this time, there is a significant semiosis, but it is carried out mainly due to the replication and polyvariance of a fairly small number of characters when the main attention was paid to the sign-icon "snake-water". At the end of stage CII-γII, there is a noticeable decrease in the number of painted dishes, which eventually disappears completely. The cessation of a certain type of semiosis is evidence of the disappearance of culture as a sign system.

Finally, the perception of sign systems as a growing, "living", evolving organism, in which, along with linear development, there are cyclical phenomena proved to be beneficial for research. The introduction of new materials and the use of other or new, more subtle means of research, might allow further studies on the issues of archaeology, history, and culturology of the Trypillia-Cucuteni community, such as:

- 1) Synchronization of local groups, the study of their genesis (as an auxiliary source, along with the typology and morphology of pottery);
- 2) Creating a typology of dishes of different local groups (as an auxiliary source, along with the morphology of dishes);
- 3) Mythology, rituals, and ideology (as the main source, along with other materials);
- 4) Some issues of sociology (as an auxiliary source);

- 5) Functioning of pictographic systems (as the main source);
- 6) society's reaction to migration, contacts with other populations, crisis phenomena (as the main source).

Concluding the work, it should be noted that not all painted vessels are involved in the analysis. We hope that further research in this area will clarify and test the hypotheses presented in the paper or refute them. That is why this work should be seen as a prolegomenon to semiotic studies of Trypillia-Cucuteni ornaments. The authors hope, that certain stages of the study will lead to similar studies of other sign systems of the Trypillia-Cucuteni community of stages A, BI-BII as well as other archaeological pre-written cultures.

LIST OF REFERENCES

1. *Bart R.* - *Барт Р.* Избранные работы. Семиотика. Поэтика. - М., 1989. - 615 с.
2. *Bakhtin M. M.* - *Бахтин М. М.* Творчество Франсуа Рабле и народная культура Средневековья и Ренессанса. - М., 1990.-542 с.
3. *Bibikov V. M.* - *Бибииков С. Н.* Раннетрипольское поселение Лука-Врублевецкая на Днестре. К истории ранних земледельческо-скотоводческих племен на юго-востоке Европы // МИА № 38. - М.-Л., 1953. - 460 с.
4. *Vikbaev V. M.* - *Бикбаев В. М.* Исследования трипольского поселения Шуры I // Археологические исследования в Молдавии в 1984 г. - Кишинев, 1989. - С. 50-61.
5. *Vikbaev V. M.* - *Бикбаев В. М.* Данные к ритуалу, связанному с оставлением кукутень-трипольских гончарных печей // Раннеземледельческие поселения-гиганты трипольской культуры на Украине. Тезисы докладов. - Тальянки, 1990.-С. 146-152.
6. *Vikbaev V. M.* - *Бикбаев В. М.* Исследования поселения культуры Кукутень-Трипольс Главан I // Материалы и исследования по археологии и этнографии Молдовы. - Кишинев, 1992. - С. 101-117.
7. *Bobrinskiy A. A.* - *Бобринский А. А.* О некоторых символических знаках, общих первобытной орнаментике всех народов Европы и Азии // Труды Ярославского областного съезда исследователей истории и древностей Ростово-Суздальской области. - М., 1902. - 24 с.
8. *Vogaevsky V. L.* - *Богаевский В. Л.* Орудия производства и домашние животные Триполья. - Л. 1937. - 312с.
9. *Bolsunovsky K.* - *Болсуновский К.* Символ Змия в трипольской культуре. - К., 1905. - 13 с.
10. *Bolsunovsky K.* - *Болсуновский К.* Символика эпохи неолита // Сфрагистические и геральдические памятники Юго-Западного края. - К. 1908. - Вып. 11.-15 с.
11. *Braginsky M. S.* - *Брагинский М. С.* Иранское литературное наследие. - М., 1984. - 295 с.
12. *Burdo N.B., Videiko M. Y.* - *Бурдо Н. Б., Видейко М. Ю.* Типы раннетрипольской керамики и ее орнаментации в междуречье Днестра и Южного Буга. // Северное Причерноморье (Материалы по археологии). - К., 1984. - С. 96-104.
13. *Wayman A. A.* - *Вайман А. А.* Знаки E и Bii в протошумерских текстах из Джемдет-Насра // Переднеазиатский сборник III. История и филология Древнего Востока. - М., 1979. - С. 57-59.
14. *Vezhbitska A.* - *Вежбицка А.* Из книги "Семантические примитивы". Введение // Семиотика-М., 1983. - С. 225-252.
15. *Videiko M. Y.* - *Видейко М. Ю.* Аграрная символика в росписи трипольской керамики // Духовная культура древнего населения Украины; Тезисы докладов научно-практической конференции. - К., 1989. - С. 47-48.
16. *Videiko M. Y.* - *Видейко М. Ю.* Жилищно-хозяйственные комплексы поселения Майданецкое и вопросы их интерпретации // Раннеземледельческие поселения-гиганты трипольской культуры на Украине. Тезисы докладов. - Тальянки, 1990.-С. 115-120.
17. *Vinogradova N. M.* - *Виноградова Н. М.* Памятники переходного этапа Триполья VI-VII в Поднестровье // Советская археология. - 1972. - № 1. - С. 36-55.
18. *Vinogradova N. M.* - *Виноградова Н. М.* Племена Днестровско-Прутского междуречья в период расцвета трипольской культуры. (Периодизация, хронология, локальные варианты). - Кишинев, 1983. - 107 с.
19. *Gadamer H. G.* - *Гадамер Х. Г.* Истина и метод. Основы философской герменевтики. - М., 1988. - 670 с.
20. *Girenko N. M.* - *Гиренко Н. М.* Синхрония и диахрония. (К вопросу об интерпретациях явлений культуры) // Древние системы письма. Этническая семиотика. - М., 1986. - С. 6-27.
21. *Holmsten V. V.* - *Гольмстен В. В.* Об элементах орнаментации керамики родового общества

- юга СССР // Труды отдела истории первобытной культуры Государственного Эрмитажа. - Л., 1941. - Т. 1. - С. 1-8.
22. Greimas A. J. - Греймас А. Ж., Курте Ж. Объяснительный словарь теории языка // Семиотика. - М., 1994. - С. 483-550.
 23. Grof S. - Гроф С. Области человеческого бессознательного. Данные исследований ЛСД. - М., 1994. - 273 с.
 24. Gusev O. O. - Гусев О. О. Пам'ятки розвинутого Трипілля Середнього Побужжя // Археологія. - 1993. - №3.-С. 114-127.
 25. Gusev O. O. - Гусев О. О. Трипільська культура Середнього Побужжя рубежу IV—III тис. до н. е. / Автореф. дис. кан. іст. наук. - К., 1993. - 20с.
 26. Danilenko V. N. - Даниленко В. Н. Неолит Украины. - К., 1969. - 260 с.
 27. Dergachev V. A. - Дергачев В. А. Выхватинский могильник. - Кишинев, 1978. - 78 с.
 28. Dergachev V. A. - Дергачев В. А. Памятники позднего Триполья (Опыт систематизации). - Кишинев, 1980. - 206 с.
 29. Dergachev V. A. - Дергачев В. А., Манзура Я. В. Погребальные комплексы позднего Триполья. - Кишинев, 1991.-334 с.
 30. Dyakonov I. M. - Дьяконов И. М. По поводу воспоминаний О. М. Фрейденберг о Н. Я. Маррс // Восток-Запад. Исследования. Переводы. Публикации. - М., 1988. - С. 178-181.
 31. Dyakonov I. M. - Дьяконов И. М. Протописьменный период в Двуречье // История Древнего Востока. Зарождение древнейших классовых обществ и первые очаги рабовладельческой цивилизации. - М., 1983. - С. 107-161.
 32. Evzlin M. - Евзлин М. Космогония и ритуал. - М., 1993. - 337 с.
 33. Evsyukov B. B. - Евсюков Б. Б. Мифология китайского неолита. - Новосибирск, 1980. - 127 с.
 34. Elizarenkova T. Y. - Елизаренкова Т. Я. "Ригведа" - великое начало индийской литературы и культуры И Ригведа. Мандалы I-IV. - М., 1989. - С. 426-543.
 35. Zaets I. I. - Заец И. И., Рыжов С. Н. Поселение трипольской культуры Клищев на Южном Буге. - К., 1992.- 176 с.
 36. Zbenovich V. G. - Збенович В. Г. Хронология позднего Триполья // Археология. - 1972. - № 7. - С. 3-25.
 37. Zbenovich V. G. - Збенович В. Г. Шумова В. А. Трипольская культура Среднего Поднестровья в свете новых исследований И Первобытная археология. - К., 1989. - С. 97-106.
 38. Zbenovich V. G. - Збенович В. Г. Поселение Бернашевка на Днестре. - К., 1980. - 178 с.
 39. Zbenovich V. G. - Збенович В. Г. Дракон в изобразительной традиции культуры Кукутени-Триполье // Духовная культура древних обществ на территории Украины. - К., 1991. - С. 20-34.
 40. Ivanov V. S. - Иванов Вяч. Вс. Чет и нечет. Асимметрия мозга и знаковых систем. - М., 1978. - 184 с.
 41. Ivanov V. S. - Иванов Вяч. Вс. История славянских и балканских названий металлов. - М., 1983. - 196 с.
 42. Ivanov V. S. - Иванов Вяч. Вс. До - вовремя - после? Предисловие / Франкфорт Г, Франкфорт Г. А., Уилсон Дж. Якобсен Т. В преддверии философии, духовные искания древнего человека. - М., 1984,- С. 3-21.
 43. Ivanov V. S. - Иванов Вяч. Вс. Примечания И Леви-Строс К. Структурная антропология. - М., 1985. - С. 340-364.
 44. Kalygin V. P. - Калыгин В. П. Язык древнейшей ирландской поэзии. - М., 1986. - 127 с.
 45. Karapetyants A. M. - Карапетянц А. М. Китайское письмо до унификации 213 г. до н.э. // Ранняя этническая история народов Восточной Азии. - М., 1977. - С. 222-257.
 46. Kifishin A. G. - Кифишин А. Г. Геноструктура догреческого и древнегреческого мифа // Образ

- смысл в античной литературе. - М., 1990. - С. 9-63.
47. Kremenetsky K. V. - Кременецкий К. В. Палеоэкология древнейших земледельцев и скотоводов Русской равнины. - М., 1991.-193 с.
 48. Krichevsky E. Y. - Кричевский Е. Ю. Орнаментация глиняных сосудов у земледельческих племен неолитической Европы И Ученые записки Ленинградского государственного университета. Историческая серия. - Вып. 15.-Л., 1949.-С. 54-110.
 49. Kruts V. O. - Круц В. О., Рыжов С. М. Фази розвитку пам'яток томашівсько-сушківської групи // Археологія. - 1985.-№ 51.
 50. Kruts V. O. - Круц В. О., Рыжов С. М. Пам'ятки трипільської культури Східної Волині // Минуле і сучасне Волині: Тези доп. 2-ї Волинської іст.-краєзн. конф. - Луцьк, 1988. - С 105-108.
 51. Kruts V. O. - Круц В. А. К истории населения трипольской культуры в междуречье Южного Буга и Днепра // Первобытная археология. - Киев. 1989. - С, 117-132.
 52. Kruts V. O. - Круц В. О. Етапи і напрямки розселення племен Трипільської культури // Подільська старовина. - Вінниця, 1993. - С. 35-44.
 53. Levi-Strauss C. - Леви-Строс К. Структурная антропология. - М., 1985. - 536 с.
 54. Livshits I. G. - Лившиц И. Г. Детерминатив к древнеегипетским словам гпуЛ "мертвец" и вПп "враг" // Яфетический сборник VI. - Л., 1930. - С. 220-230.
 55. Linnichenko I. A. - Линниченко И. А., Хвойко В. В. Сосуды со знаками из находок на площадках трипольской культуры // Записки императорского одесского общества Истории и Древностей. - Одесса, 1901. - Т. XXIII.-С. 192-202.
 56. Lotman Y. M. - Лотман Ю. М. Текст и полиглотизм культуры И Избранные статьи. - Таллинн, 1992. - Т. 2. - С.142-147.
 57. Lotman Y. M. - Лотман Ю. М. О семиосфере И Избранные статьи. - Таллинн, 1992. - Т 1. - С. 11-24.
 58. Makarevich M. L. - Макаревич М. Л. Об идеологических представлениях у трипольских племен // Записки Одесского археологического общества. - К., 1960. - Т 1(34). - С. 290-301.
 59. Malinovsky B. - Малиновский Б. Магия, наука и религия И Магический кристалл. Магия глазами ученых и чародеев. - М., 1992. - С. 94-127.
 60. Manzura I. V. - Манзура И. В., Субботин А. В. Новые раскопки Выхватинского могильника // Археологические исследования в Молдавии в 1984 г. - Кишинев, 1989. - С. 76-95.
 61. Markevich V. I. - Маркевич В. И. Позднетрипольские племена Северной Молдавии. - Кишинев, 1981. - 190 с.
 62. Markevich V. I. - Маркевич В. И. Далекое-близкое. - Кишинев, 1985. - 167 с.
 63. Markevich V. I. - Маркевич В. И. Антропоморфизм в художественной керамике культуры Триполье-Кукутень И Памятники древнейшего искусства на территории Молдавии. - Кишинев, 1989. - С. 26-36.
 64. Masson V. M. - Массон В.М. Первые цивилизации. - Л., 1989. - 275 с.
 65. Matskeviy L. G. - Мацкевий Л. Г. До питання про заселення печерних комплексів у період трипільської культури на заході України // Трипільська культура України (до 100-річчя відкриття): Тези доповідей і повідомлень міжнародної наукової конференції. - Львів, 1993. - С. 35-37.
 66. Movsha T. G. - Мовша Т. Г. Изображение быка на раннетрипольском сосуде из Озаринец // КСИ А, 1961- Вып. 11.-С. 82-83.
 67. Movsha T. G. - Мовша Т. Г. Зображення птахів на розписному посуді Трипільської культури // Археологія. - 1965.-Т. XIX.-С. 100-105.
 68. Movsha T. G. - Мовша Т. Г. Періодизація і хронологія середнього та пізнього Трипілья // Археологія. - 1972. - № 5. - С. 3-23.

69. *Movsha T. G. - Мовша Т. Г. Новые данные по идеологии трипольско-кукутенских племен // Первобытная археология - поиски и находки. - К., 1980.-С. 185-198.*
70. *Movsha T. G. - Мовша Т. Г. Средний этап трипольской культуры // Археология Украинской ССР: В 3-х т. - К., 1985.-Т. 1.-С. 206-223.*
71. *Movsha T. G. - Мовша Т. Г. Антропоморфные сюжеты на керамике культур трипольско-кукутенской общности // Духовная культура древних обществ на территории Украины. - К., 1991. - С. 34-47.*
72. *Morris C. W. – Моррис Ч. У. Из книги “Значение и означивание”. Знаки и действия // Семиотика. - М., 1983.- С. 118-182.*
73. *Morris C. W. – Моррис Ч. У. Основания теории знаков // Семиотика. - М., 1983. - С. 37-39.*
74. *Novitsky E. Y. - Новицкий Е. Ю., Полищук Л. Ю. Об одной группе-изображении на сосудах трипольской культуры // Материалы по археологии Северного Причерноморья. - К., 1983. - С. 136-141.*
75. *Parmenter R. - Парментьер Р. Элементарная теория истины Пирса // Знаковые системы в социальных и когнитивных процессах. - Новосибирск, 1990. - С. 25-39.*
76. *Passek T. S. - Пассек Т. С. Трипільська культура. - К., 1941. - 83 с.*
77. *Passek T. S. - Пассек Т. С. Периодизация трипольских поселений (III–II тыс. до н.э.) // МИА. - 1949. - № 10. -245 с.*
78. *Pelts E. - Пельц Е. Семиотика и логика // Семиотика. - М, 1983. - С. 137-150.*
79. *Petrenko V. G. - Петренко В. Г. Каменная плита с изображением из Усатово // Северное Причерноморье (Материалы по археологии). - К., 1984. - С. 14-23.*
80. *Petrenko V. G. - Петренко В. Г. Новые источники и проблемы изучения Позднего Триполья - на западе причерноморских степей И Памятники трипольской культуры в Северо-Западном Причерноморье. - К., 1989.-С. 50-124.*
81. *Polishchuk L. Y. - Полищук Л. Ю. Памятники развитого Триполья // Памятники трипольской культуры в Северо- Западном Причерноморье. - К., 1989. - С. 30-49.*
82. *Rorova T. A. - Попова Т. А. О роли населения Поднестровья в формировании трипольской культуры Буго- Днепроовского междуречья И Первобытная археология. - К., 1989. - С. 142-148.*
83. *Reformatorsky A. A. - Реформатский А. А. Лингвистика и поэтика. - М., 1987. - 262 с.*
84. *Ryzhov S. M. - Рыжов С. М. (а) Небелівська група пам'яток трипільської культури // Археологія. - 1993. - №3.-С. 101-114.*
85. *Ryzhov S. M. - Рыжов С. М. (б) Дослідження трипільських поселень по р.Лядовій у Середньому Подністров'ї // Подільська старовина. - Вінниця, 1993. -С. 85-96.*
86. *Riker P. - Рикер П. Что меня занимает последние 30 лет И Историко-философский ежегодник. - 1991. - С.296-316.*
87. *Rudnev V. - Руднев В. Людвиг Витгенштейн в культуре XX столетия // Даугава. -1989. -№2. - С. 95-98.*
88. *Rybakov V. A. - Рыбаков Б. А. Семантика трипольского орнамента: Тезисы докладов на заседаниях, посвященных итогам полевых исследований. 1963.-М., 1964.-С. 11-13.*
89. *Rybakov V. A. - Рыбаков Б. А. Космогония и мифология земледельцев энеолита // Советская археология. - 1965. - № 1. - С. 24-47; - № 2. - С. 13-33.*
90. *Rybakov V. A. - Рыбаков Б. А. Язычество древних славян. - М., 1981. - 606 с.*
91. *Sorokin V. Y. - Сорокин В. Я. Раскопки многослойного поселения Мерешовка-Четецуе в 1980 г. // Археологические исследования в Молдавии в 1979-1980 гг. - Кишинев, 1983. - С. 102-112.*
92. *Sorokin V. Y. - Сорокин В. Я. К проблеме хронологии памятников Среднего Триполья Молдовы // Раннеземледельческие поселения-гиганты трипольской культуры на*

- Украине: Тезисы докладов. - Тальянки, 1990.-С. 94-101.
93. Saussure F. - Соссюр Ф. Труды по языкознанию. - М., 1977. - 695 с.
94. Starikov V. S. - Стариков В. С. Прозаические и стихотворные тексты малого киданьского письма XI-XII вв. И Забытые системы письма. Остров Пасхи, Великое Дао, Индия. Материалы по дешифровке. - М., 1982.-С. 99-210.
95. Stepanov Y. S. - Степанов Ю. С. Семиотика. - М., 1971. - 145 с.
96. Stolyar A. D. - Столяр А. Д. Происхождение изобразительного искусства. - М., 1985. - 296 с.
97. Todorova T. D. - Тодорова Т. Д. Результаты исследований на поселении Флорешты V // Археологические исследования в Молдове в 1986 г. - Кишинев, 1992. - С. 58-72.
98. Toporov V. N. - Топоров В. Н. Несколько параллелей к одной древнеегипетской мифологеме // Древний Восток: Сб. 2. - М., 1980. - С. 75-97.
99. Toporov V. N. - Топоров В. Н. О ритуале. Введение в проблематику И Архаический ритуал в фольклорных и раннеслитсратурных памятниках. - М., 1988. - С. 5-60.
100. Turner V. - Тэрнер В. Символ и ритуал. - М., 1983. - 277 с.
101. Frank D. - Фрэнк Д. Пространственная форма в современной литературе И Зарубежная эстетика и теория литературы XIX-XX вв. Трактаты, статьи, эссе. - М., 1987. - С. 194-213,
102. Harner J. M. - Харнер Дж. М. Путь шамана. - Харьков, 1991. - 187 с.
103. Khvoiko V. V. - Хвойко В. В. Раскопки в 1901 г. в области трипольской культуры. - СПб., 1904. - С. 25.
104. Tsvek O. V. - Цвек О. В. Трипільська посудина з антропоморфними зображеннями // Археологія. - Т. XVI. - 1964.-С. 76-81.
105. Tsvek O. V. - Цвек Е. В. Буго-днепровский вариант восточнотрипольской культуры: (К проблеме выделения культур и локальных вариантов Триполья) // Первобытная археология. - К., 1989. - С. 106-117.
106. Tsvek O. V. - Цвек О. В. Релігійні уявлення населення Трипілья // Археологія. - 1993. - № 3. - С. 74-90.
107. Tsibeskov V. P. - Цибеков В. П. Обряд "поїння землі" та культ місяця в ідеологічних уявленнях трипільських племен // Археологія. - 1984. - № 47. - С. 13-24.
108. Tsvyan T. V. - Цивьян Т. В. Лингвистические основы балканской модели мира. - М., 1990. - 203с.
109. Chernysh E. K. - Черныш Е. К. Энеолит Правобережной Украины и Молдавии // Энеолит СССР - М., 1982. - С.166-320.
110. Shaposhnikova O. G. - Шапошникова О. Г., Неприна В. И. Новорозановское многослойное поселение // Древности Поингуля. - К., 1977. - С. 52-65.
111. Shatsky E. - Шацкий Е. Утопия и традиция. - М., 1990. - 455 с.
112. Shmagly M. M. - Шмаглій М. М., Рыжов С. М., Дудкін В.П. Трипільське поселення Коновка в Середньому Подністров'ї // Археологія. - 1985. - № 52. - С. 42-52.
113. Shmagly M. M. - Шмаглій М. М., Відейко М. Ю. Пізньотрипільське поселення поблизу с. Майданецького на Черкащині // Археологія. - 1987. - № 60. - С. 58-71.
114. Schmitt F. I. - Шмит Ф.И. Стадиальность и историзм // Яфетический сборник VI. - Л., 1930. - С. 1-5.
115. Stern E. R. - Штерн Э. Р. Догреческая культура на юге России // Труды XIII Археологического съезда в Екатеринославле в 1905 г. - М., 1906. - Т 1. - С. 9-95.
116. Yakubenko O. O. - Якубенко О. О. Охоронні розкопки трипільського поселення Володимирівка (Кіровоградська обл.), проведені у 1989-1990 роках // Археологічні дослідження, проведені на території України протягом 80-х років державними органами охорони пам'яток та музеями республіки. - К., 1992. - С. 61-76.

117. *Yarovoy E. V. - Яровой Е. В.* Курганы энеолита - эпохи бронзы Нижнего Поднестровья. - Кишинев, 1990. - 272 с.
118. *Childe V. Gordon/Schipcnitzi: aLateNcolitic Station with Painted Pottery in Bukowina//The Journal of the Royal Anthropological Institute of Great Britain and Ireland.* - LIII. - London, 1923. - P.263-288.
119. *Cucoş S. Săpăturile de la Văleni-Piatra Neamţ. (1974-1975) // Memoria Antiquitatis VI-VIII.* - 1981.-P. 35-56.
120. *Dumitrescu V La station prehistorique de Traian // Dacia.* - 1941-1944. - IX-X. -1945. - P. 11-114.
121. *Dumitrescu V. Arta preistorica în Romania.* - Bucureşti, 1974. - 511 p.
122. *Dumitrescu V. Arta culturii Cucuteni.* - Bucurcşti. - 1979. - 114 p.
123. *Dinu M. Şantierul arheologic Valea Lupului // Materiale şi cercetări arheologice.* - 1957. - Vol. III-V- P. 161-178.
124. *Falkenstein A. Archaische texte aus Uruk.* - Leipzig. 1936. - 216 s.
125. *Gimbutas M. The Gods and Goddesses of Old Europe.* - London, 1973. - 216 p.
126. *Hadaczek K. La colonie industrielle de Koszylowce. Album.* - Lwów, 1914.
127. *Matasă C. Frumusica. Village prehistorique à ceramique peinte dans la Moldovie du Nord Roumanie.* - Bucureşti, 1946. - 208 p.
128. *Mataşă C. Aşezarea eneolitică Cucuteni B de la Tîrgu Ocna-Podei (raionul Tîrgu Ocna, reg. Bacau H Archaeologia Moldovei.* - Vol. II-III. - 1964. - P. 11-66.
129. *Niţu A. Ceramica Cucuteni B de la Miorcani (Botoşam) // Memoria Antiquitatis.* - 1969. -No 1. - P. 279-298.
130. *Niţu A. Formarea si clasificaria grapelor dc stil AB şi B ale ccramicii pictate Cucuteni-Tripolie.* - Iaşi, 1984,- 133 p.
131. *Kozłowski L. Zarys pradziejów Polski Południowo-Wschodniej.* - Lwów, 1939. -242 s.
132. *Kandyba O. Schipenitz. Kunst und Geräte eines neolithischen Dorfes.* - Wien-Leipzig, 1937. -156 s.
133. *Ossowski G. Sprawozdanie drugie z wycieczki paleoetnologicznej po Galicji w r. 1890 // Zbiór wiadomości do antropologii krajowej.* - Kraków. - 1891. - T. XV. - S.I-88.
134. *Ossowski G. Sprawozdanie trzecie z wycieczki paleoetnologicznej po Galicji w r. 1891 // Zbiór wiadomości do antropologii krajowej.* - Kraków. - 1892. - T. XVI. - S.63-96.
135. *Passek T. S. La ceramique Tripolienne.* - M.L., 1935. - 165 p.
136. *Winn M. M. Shan. Pre-writing in South-Eastern Europe: The Sign System of the Vinca Culture 4000 BC.-Berkley, 1981,- 118 p.*
137. *Zaharia N., Petrescu-Dimbovita, Zaharia Em. Aşzâri din Moldova. De la paleolitic pînă în secolul al XVIII - lea.* - Bucureşti, 1970. - 661 p.

LIST OF FIGURES

Figure 1: Location of Trypillia monuments, the materials of which were used in the work area of distribution of burials of Usatove type.....	45
Figure 2.....	119
Figure 3.....	120
Figure 4.....	120
Figure 5.....	120
Figure 6.....	121
Figure 7.....	121
Figure 8.....	121
Figure 9.....	122
Figure 10.....	122
Figure 11.....	122
Figure 12.....	123
Figure 13.....	123
Figure 14.....	123
Figure 15.....	126
Figure 16.....	126
Figure 17.....	126
Figure 18.....	128
Figure 19.....	128
Figure 20.....	128
Figure 21.....	128
Figure 22.....	130
Figure 23.....	130
Figure 24.....	130
Figure 25.....	130
Figure 26.....	131
Figure 27.....	131
Figure 28.....	131
Figure 29.....	131
Figure 30: Monthly coding on biconical utensils and a cup from Tomashivka settlements.....	139
Figure 31: Dynamics of the use of basic signs (basic semantic markers) by the Trypillia-Cucuteni population between the Sob and Sinyukha rivers and the Southern Bug and Dnieper rivers	148
Figure 32: Dynamics of the use of basic signs (basic semantic markers) by the Trypillia-Cucuteni population of the interfluve of the Southern Bug and the Dnieper.....	148
Figure 33: Dynamics of the use of basic signs (basic semantic markers) by the Trypillia-Cucuteni population of the interfluve of the Southern Bug and the Dnieper.....	149
Figure 34: Dynamics of the use of basic signs (basic semantic markers) by the Trypillia-Cucuteni population of the Southern Bug and the Dnieper interfluve and the middle Bug basin.....	149
Figure 35: Dynamics of the use of basic signs (basic semantic markers) by the Trypillia-Cucuteni population of the middle Bug basin	150

Figure 36: Dynamics of the use of basic signs (basic semantic markers) by the Trypillia-Cucuteni population of Upper Dniester and Prut basin	150
Figure 37: Dynamics of the use of basic signs (basic semantic markers) by the Trypillia-Cucuteni population of the Middle Dniester and the interfluve of the Prut and Dniester rivers	151
Figure 38: Dynamics of the use of basic signs (basic semantic markers) by the Trypillia-Cucuteni population of the Middle Dniester and the Right Bank of the Prut	151
Figure 39: Dynamics of the use of basic signs (basic semantic markers) by the Trypillia-Cucuteni population of the Prut and Dniester interfluve, Upper Dniester and the Right Bank of the Prut	152
Figure 40: Dynamics of the use of basic signs (basic semantic markers) by the Trypillia-Cucuteni population between the Prut and Dniester rivers and the Middle Dniester	152
Figure 41: Dynamics of the use of basic signs (basic semantic markers) by the Trypillia-Cucuteni population of the Upper and Middle Dniester.....	153
Figure 42: Dynamics of the use of basic signs (basic semantic markers) by the Trypillia-Cucuteni population of the Lower Dniester and the Black Sea region	153
Figure 43: Schemes of painting cups of Tomashivka settlements: 1-3 - static compositions; 4 - dynamic composition; 5 - combining static and dynamic compositions.	156
Figure 44: Connections between dwellings at the sign level (more than 10 signs)	185
Figure 45.....	227
Figure 46.....	227
Figure 47.....	227
Figure 48.....	228
Figure 49.....	229

LIST OF HISTOGRAMS

Histogram 1: The use of painting schemes	156
Histogram 2: Use of painting schemes	157
Histogram 3: Use of painting schemes	157
Histogram 4	224
Histogram 5	224
Histogram 6: The ratio of signs and painted pottery	230
Histogram 7: The ratio of signs and painted pottery	230
Histogram 8: The ratio of signs and painted pottery	231
Histogram 9: The ratio of signs and painted pottery	231
Histogram 10: The ratio of signs and painted pottery	232
Histogram 11: The ratio of signs and painted pottery	232
Histogram 12: The ratio of signs and painted pottery	233
Histogram 13: The ratio of signs and painted pottery	233

LIST OF TABLES

Table 1: Relative chronology of Trypillia-Cucuteni settlements of stages BII-CII, the materials of which were used in the work	37
Table 2: Signs of the settlement of Maidanetske	160
Table 3	161
Table 4	162
Table 5	163
Table 6	164
Table 7	165
Table 8	166
Table 9	167
Table 10	168
Table 11	169
Table 12	170
Table 13	171
Table 14	172
Table 15	173
Table 16	174
Table 17	175
Table 18	176
Table 19	177
Table 20	178
Table 21	179
Table 22	180
Table 23	181
Table 24	182
Table 25	183
Table 26	184
Table 27: Taliianki settlement signs.	186
Table 28	187
Table 29	188
Table 30	189
Table 31	190
Table 32	191
Table 33	192
Table 34	193
Table 35	194
Table 36	195
Table 37	196
Table 38	197
Table 39	198
Table 40	199
Table 41	200

Table 42	201
Table 43	202
Table 44	203
Table 45	204
Table 46	205
Table 47	206
Table 48	207
Table 49	208
Table 50	209
Table 51	210
Table 52: Catalogue of signs on painted pottery from Talianki	216
Table 53: Catalogue of signs on painted pottery from Talianki (continued).....	217
Table 54: Catalogue of signs on painted pottery from Maidanetske	218
Table 55: Catalogue of signs on painted pottery from Maidanetske (continued)	219
Table 56: Catalogue of signs on painted pottery from Maidanetske (end)	220

ABOUT AUTHORS



Prof. Dr. Yaroslav Melnyk is a Ukrainian philologist, linguist, Slavic scholar, doctor of philology, in November 2014 he received the title of professor at Vasyl Stefanyk Precarpathian National University, Department of General and German Linguistics. He was born in 1960 in Ivano-Frankivsk. Educated as an artist-designer, he studied at the Polytechnic in Kharkiv as well as at the Faculty of Physics and Mathematics. In 1986 graduated from the Faculty of Philology of Ivano-Frankivsk-whom the pedagogical institute. Melnyk Yaroslav is the author of more than 200 publications (including more than 5 monographs, 30 textbooks, and manuals) on the problems of linguistics, linguistic philosophy, semiotics, culturology. His doctoral dissertation is devoted to modern problems of linguistics, micro- and macrosystem levels in language, linguoculturology, semiology, linguoanthropological philosophy, neo-rhetoric studies.



Taras Tkachuk, Ph.D. is the head of the department of archaeology of the National Reserve “Ancient Halych”, Ukraine. In 1985 he graduated from Taras Shevchenko Kyiv State University. From 1985 to 1992 he worked at the Institute of Archaeology of the National Academy of Sciences of Ukraine as a senior laboratory assistant. From 1992 to 1995 he studied at the Institute of Archaeology of the National Academy of Sciences of Ukraine. He was awarded the Diploma of the Ministry of Culture and Arts of Ukraine, the Fulbright Scholarship at Stanford, the University of Arizona, and others. Taras Tkachuk is a member of the European Association of Archaeologists and author of over 100 articles. His research interests include the neo-Eneolithic archaeology of South-Western Europe, semiotics, philosophy, and methodology of science.



Oleksandr Melnyk, MSc. received his master's degree in renewable energy systems engineering at the University of Applied Sciences Technikum Wien. In his thesis, he investigated the energy flexibility potentials based on building information modeling. For this work, he received the “Energietechnik-Preis 2020” award from the Austrian Association of Electrical Engineers - OVE. In 2017, at China, Three Gorges University (Department of Architecture and Urban Planning) Oleksandr worked on the development of energy-efficient construction concepts in a subtropical Asian climate with a specific focus on improved quality control of innovative building renovation projects. Apart from renewable energy systems and engineering, his interests include the methodology of science, social sciences, history of art, and philosophy. This book is his second Ukrainian-English translation in the field of semiotics.

Scientific publication

Taras Tkachuk
Yaroslav Melnyk

SEMIOTIC ANALYSIS OF TRYPILLIA-CUCUTENI SIGN SYSTEMS

Scientific editor Volodymyr Kruts

Technical editor Viktor Kosakivsky

Proofreader Lyudmyla Shutova

Digital typesetting Andriy Raifurak; Lyudmyla Slobodyanyuk

Translation to English, cover design and technical editing by

Oleksandr Melnyk

Typesetting of the print version

Oleksandr Melnyk

Yaroslav Semko

Signed for printing 14.04.2021. Format 60x84 / 8.
Offset paper. Digital printing. Type Times New Roman.
Cond. printed sheets. 28,60. Circulation 300 copies.

Publisher – Symphony Forte
76019, Ivano-Frankivsk, street Kraykivsky, 2
tel. +38 0342 77-98-92

Certificate of inclusion of the subject of publishing in the state register of publishers
and manufacturers of publishing products: series DK № 3312 dated 12.11.2008

Manufacturer – FOP Semko Ya.Yu.
76019, Ivano-Frankivsk, street Kraykivsky, 2
tel. + 38-067-342-56-46